

Preliminary

GENERAL DESCRIPTION

EM32117 is a CMOS 16-digit LCD panel driver. The EM32117 can receive dialing information such as dialing digits, Pause, Flash, Pulse to Tone mode from EMC EM91465 series dialer IC and display the corresponding pattern on the LCD panel. The EM32117 also supports various indicators such as the icons of STORE, SAVE, Speaker phone (or Hand-Free), Lower or Upper page, Hold, etc. to support high-end feature phone applications. The EM32117 can operate in stand-alone mode to display calendar and real time clock, conversation time (stopwatch). The EM32117 also provides check the last conversation time function.

FEATURES

- ON-HOOK check last conversation time function.
- General flag display function for LOGO indication.
- Low power consumption: 1.5µA (max.)
- Uses single clock 32768 Hz crystal (with built-in capacitor, no need extra capacitor).
- LCD blank 2 sec after OFF-HOOK, to protect the STW data.
- Built-in serial data interface (compatible with EM91465 series).
- Driver for 4.5-volt, 16-digit, 1/4 duty , 1/3 bias LCD panel with built-in voltage tripler circuit.
- Display dialing phone number.
- Display calendar and real time clock (RTC) in 12 hour or 24 hour format.
- Stopwatch function for counting conversation time up to 59 minutes 59 seconds.
- Operating voltage: 1.5 VDC (typical)
- Dice form, QFP 80 pin package, and LCM (Liquid Crystal display Module) are available.

APPLICATION

- LCD Feature phone and Digital display system.

PIN ASSIGMENT

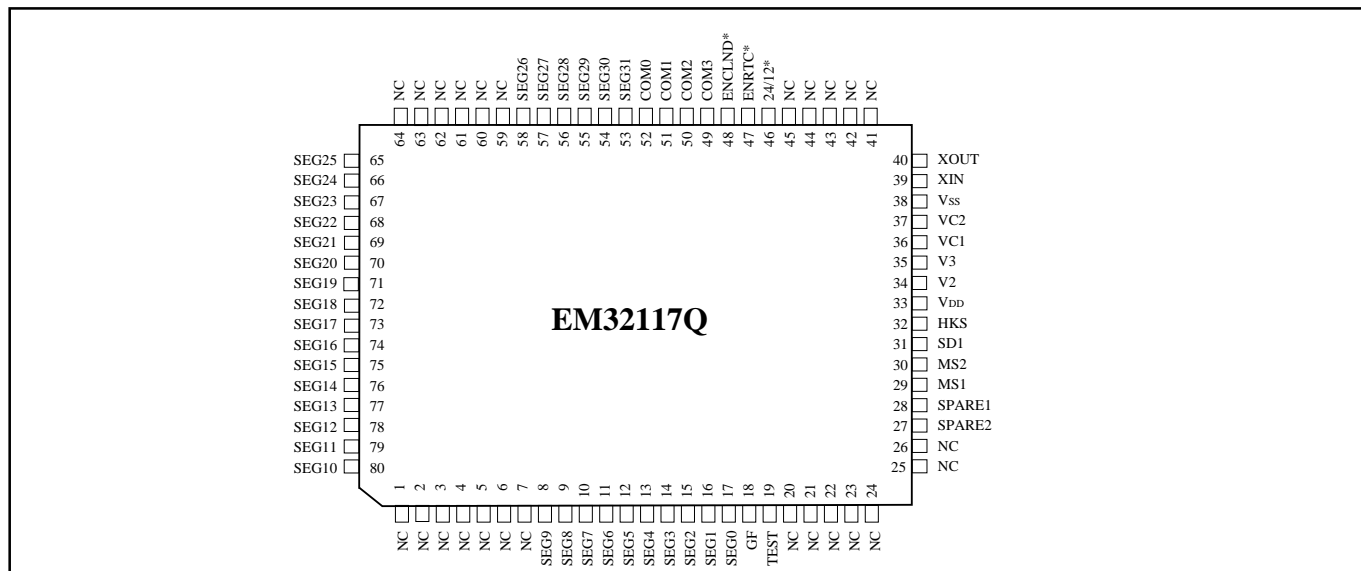

Preliminary

FUNCTION BLOCK DIAGRAM

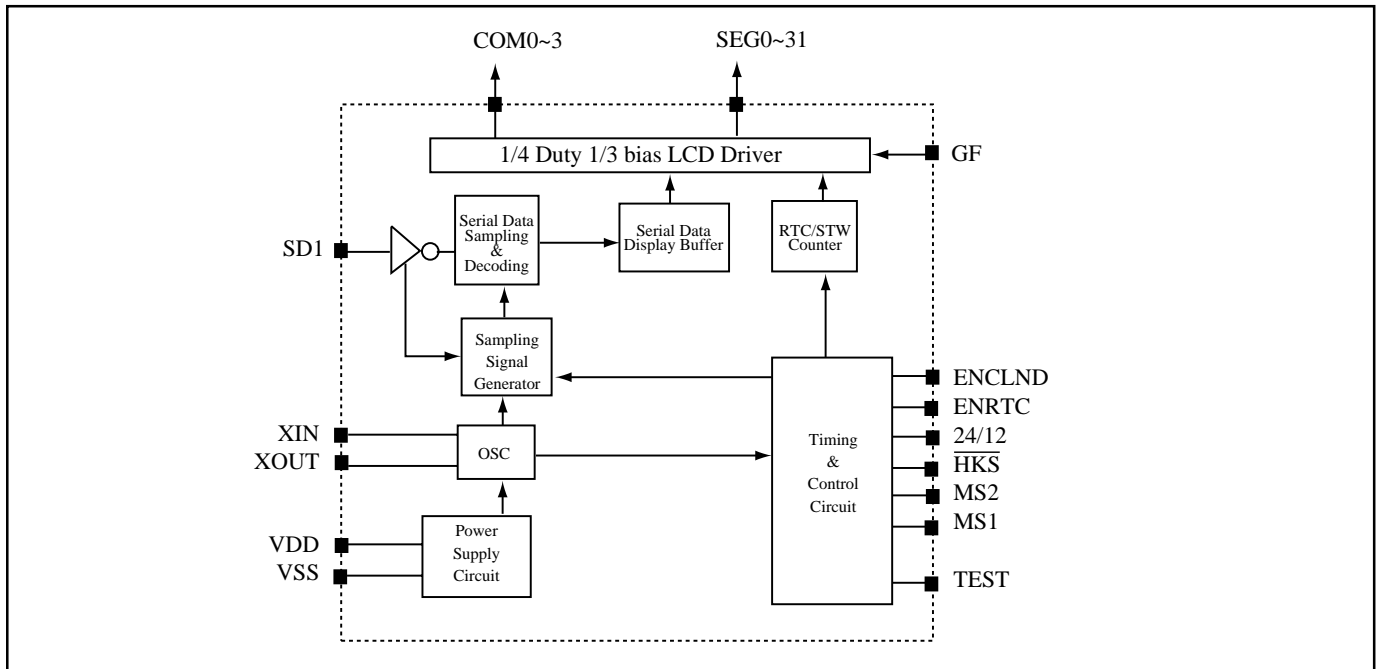

PIN DESCRIPTION

Pin Name	Description
SPARE1, SPARE2	Need to be connected to V_{SS} .
COM0~COM3	LCD panel driver common output pins.
SEG0~SEG31	LCD panel driver segment output pins.
TEST	Reserved for testing, should be left open.
MS1	Manual setting and check last conversation time input pin 1, with built-in pull-up optimal resistor. The optimal resistor before keying=100k Ω , after keying change to 1M Ω for reducing power consumption.
MS2	Manual setting input pin 2 with built-in pull-up; optimal resistor. The optimal resistor before keying=100k Ω , after keying change to 1M Ω for reducing power consumption.
SDI	Serial data input pin with built-in 150 K Ω pull-up resistor.
HKS	Hook switch status input pin with built-in 1 M Ω pull-up resistor.
V_{DD} , V_{SS}	Positive power supply pin.
V2, V3	Voltage tripler circuit for LCD driver.
VC1, VC2	Voltage tripler circuit for LCD driver.
XIN, XOUT	Crystal input and output pins for connecting a 32768Hz crystal (Internal built-in 2-p capacitor).
24/12	RTC display 24 or 12 hours format selection pin (when this pin is pulled "high, RTC will be displayed in 24 hour format. Otherwise will be display in 12 hour format).
ENCLND	Calendar enable pin. When disabled (ENCLND* = high), the Calendar field of LCD panel will be blanked. When 12 digit LCD panels are used, Calendar should be disable to suppress output of calendar.
ENRTC	RTC enable pin. When disabled (ENRTC* = high), the LCD panel will be blanked when HKS pin is at high level.
GF	General Flag input pin without built-in resistor. When GF pull "High" LCD panel will display Icon. GF pull "Low", "GF" Icon will blank.

* This specification are subject to be changed without notice.

Preliminary

LCD Panel Description

The display font of the EM32117 LCD driver is shown as the following:

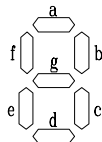
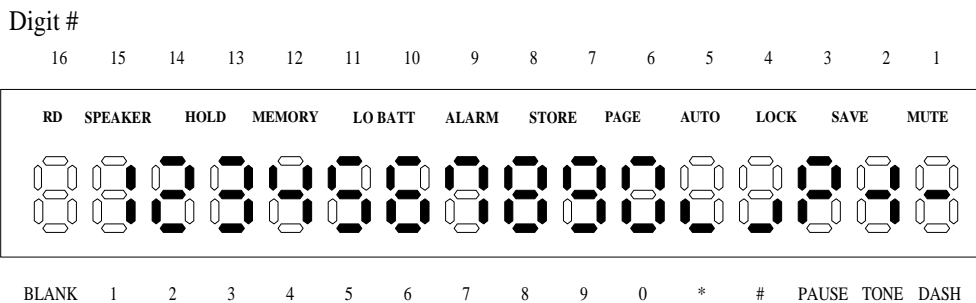

	SEG31	SEG30	SEG29	SEG28	SEG27	SEG26	SEG25	SEG24
COM3	16f	16a	15f	15a	14f	14a	13f	13a
COM2	16g	16b	15g	15b	14g	14b	13g	13b
COM1	16e	16c	15e	15c	14e	14c	13e	13c
COM0	16d		15d		14d		13d	

	SEG23	SEG22	SEG21	SEG20	SEG19	SEG18	SEG17	SEG16
COM3	12f	12a	11f	11a	10f	10a	9f	9a
COM2	12g	12b	11g	11b	10g	1b	9g	9b
COM1	12e	12c	11e	11c	10e	10c	9e	9c
COM0	12d	RD	11d	Speaker	10d	HOLD	9d	Memory

	SEG15	SEG14	SEG13	SEG12	SEG11	SEG10	SEG9	SEG8
COM3	8f	8a	7f	7a	6f	6a	5f	5a
COM2	8g	8b	7g	7b	6g	6b	5g	5b
COM1	8e	8c	7e	7c	6e	6c	5e	5c
COM0	8d	GF	7d	ALARM	6d	STORE	5d	PAGE

	SEG7	SEG6	SEG5	SEG4	SEG3	SEG2	SEG1	SEG0
COM3	4f	4a	3f	3a	2f	2a	1f	1a
COM2	4g	4b	3g	3b	2g	2b	1g	1b
COM1	4e	4c	3e	3c	2e	2c	1e	1c
COM0	4d	AUTO	3d	LOCK	2d	SAVE	1d	MUTE

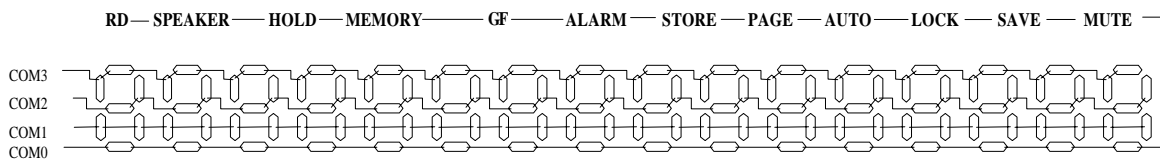

Preliminary

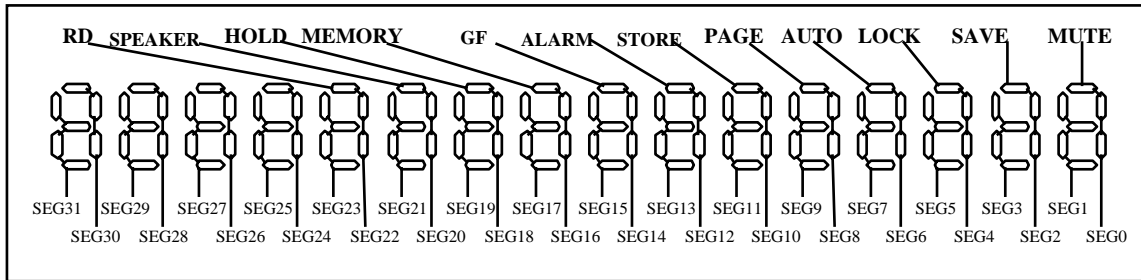
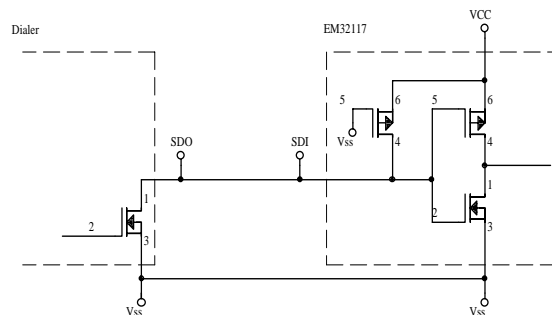

Figure 2 - Segment pin wiring diagram

Serial Data Interface

Since the serial data transmitters (e.g. EM91465 series dialers) may have different voltage level from EM32117, therefore the following interconnecting scheme is recommended when using the EM32117 as a serial data receiver. The SDO output from the serial data transmitters should be of NMOS open-drain structure as shown below.



Data Format

When the EM32117 senses the falling edge of the Start bit, it will sample subsequent bits in the middle of each bit. The received bit will then be assembled and decoded, and corresponding pattern will be displayed on LCD panel. The serial data format is as follows:

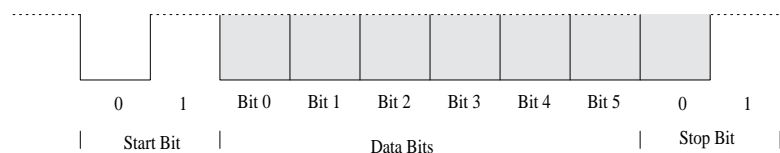

Protocol

There are three categories of dialing data, and representation and interpretation of serial data is as the following:

(Note: Codes 0000 and 1111 will be interpreted as " " (blank pattern) and "-" patterns, respectively and they will shift on LCD panel just as other digit codes.

Preliminary

* Keypad,SDO format and LCD display reference table:

Keypad	bit5	bit4	bit3	bit2	bit1	bit0	Display
1	0	0	0	0	0	1	1
2	0	0	0	0	1	0	2
3	0	0	0	0	1	1	3
4	0	0	0	1	0	0	4
5	0	0	0	1	0	1	5
6	0	0	0	1	1	0	6
7	0	0	0	1	1	1	7
8	0	0	1	0	0	0	8
9	0	0	1	0	0	1	9
0	0	0	1	0	1	0	0
"*/T	0	0	1	0	1	1	
#	0	0	1	1	0	0]
P	0	0	1	1	0	1	P
*/"T"	0	0	1	1	1	0	-
ST	1	0	0	0	0	0	STORE
HOLD	1	0	1	0	0	0	HOLD
HF	1	0	1	0	1	0	Speaker
Page	1	0	1	1	0	0	PAGE
A	1	0	1	1	1	0	A
F	1	0	1	1	1	1	clear all display
(Lock state)	1	0	0	0	0	1	Lock
MUTE	1	0	0	0	1	0	MUTE
Note 3	1	0	0	0	1	1	ALARM
EM1~EM3	1	1	1	1	0	0	MEMORY
M1~M40	1	1	1	1	0	0	MEMORY
RD	1	1	1	1	0	1	RD
SAVE	1	1	1	1	1	0	SAVE

Note:

1. Flash key will be treated as "clear LCD panel" command.
 2. When lock condition establish.
 3. MUTE and ALARM indicators will toggle with each received SDI code.
 4. Any invalid data will be ignored by the EM32117.
- General flag display function. EM32117 provide General Flag Icon, when GF pin pull "high", then "GF" Icon will be displayed. GF pin pull "low", the "GF" Icon will blank. The "GF" Icon can identify by user for special distinguishment.

FUNCTION DESCRIPTION

Operation Modes and System States

Depending on which state the EM32117 is in, the system will operate in one of two modes, namely, RTC mode and Stop-watch mode. In the State 1, as defined by the State-diagram in figure 4, the system operates in Real-Time Clock mode, otherwise, the system operates in Stop-Watch mode. The flow chart is as follows:

Preliminary

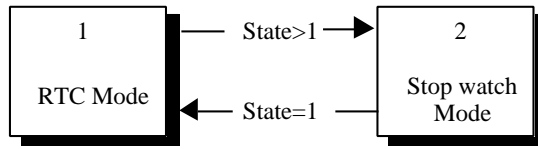

Figure 3 - Top Level Flow Chart

The system can be in one of the six states as defined by the following state diagram. The transitions between states are driven by the level of HKS pins as well as Serial Data "Hand-Free" and "Hold".

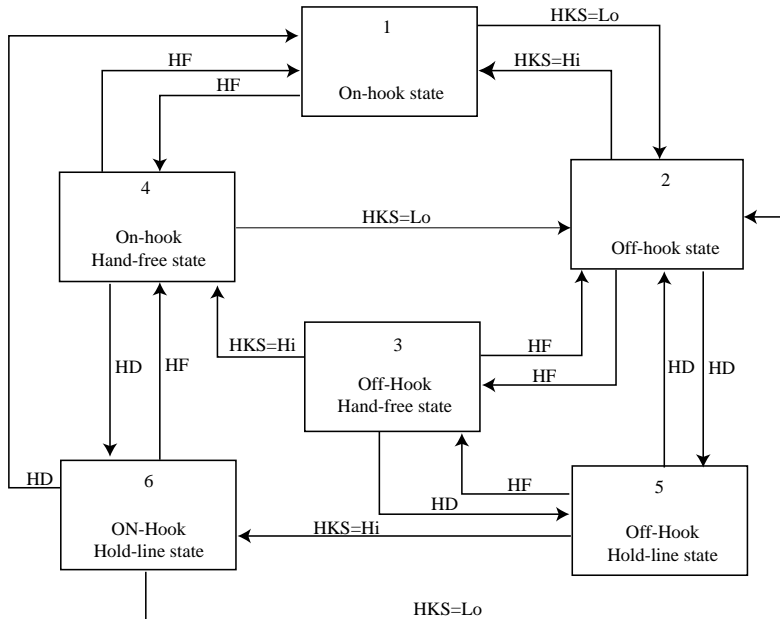
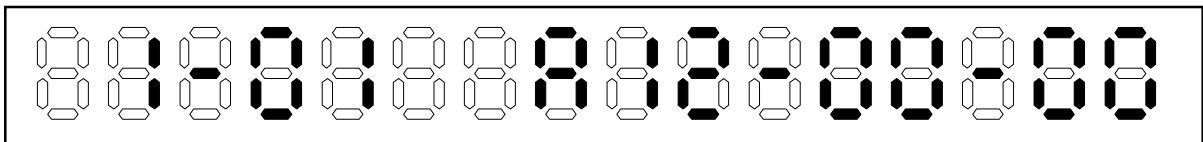

Figure 4 - System State Diagram

RTC (Real time clock) Mode

When the system is in State 1 and RTC function is enabled (ENRTC pin at low level), the EM32117 will be in Real-Time Clock display mode. There are two different RTC display formats available, e.g., 12 or 24 hours format selected by 24/12 pin. When this pin is pulled "high", RTC will be displayed in 24 hour format. When "low", RTC will be displayed in 12 hour format, as shown in the following:

12 hour format:



24 hour format:

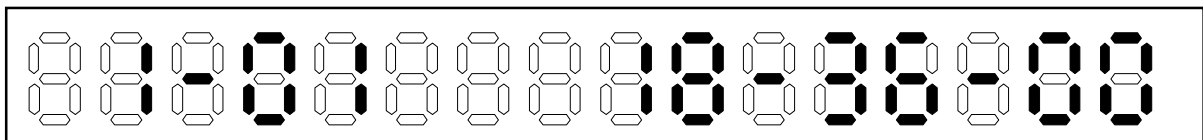

Preliminary

Setting Calendar and Real-Time clock

When the system is in State 1 (ON-HOOK idle state), the calendar and Real-Time Clock can be set up by operating MS1 and MS2 pins as described in the following:

1. When the system is in State 1, press MS1 and hold for over 2 sec, month digits will flash,
2. Press MS2 to increment month digits.
3. Press MS1 once again, day digits will flash,
4. Press MS2 to increment day digits.
5. Press MS1 again, hour digits will flash.
6. Press MS2 to count up data.
7. Press MS1 once again, minute digits and flash,
8. Press MS2 to count up minute digits.
9. Press MS1 again to finish RTC set up, and the second digit will be reset.

Note:

1. If MS2 are pressed and hold for over 2 seconds, then data automatically count up in every 0.5 sec.
2. Digit flash time is 1 Hz (0.5 sec on, 0.5 sec off)

The flow chart of RTC mode is as follows:

Preliminary

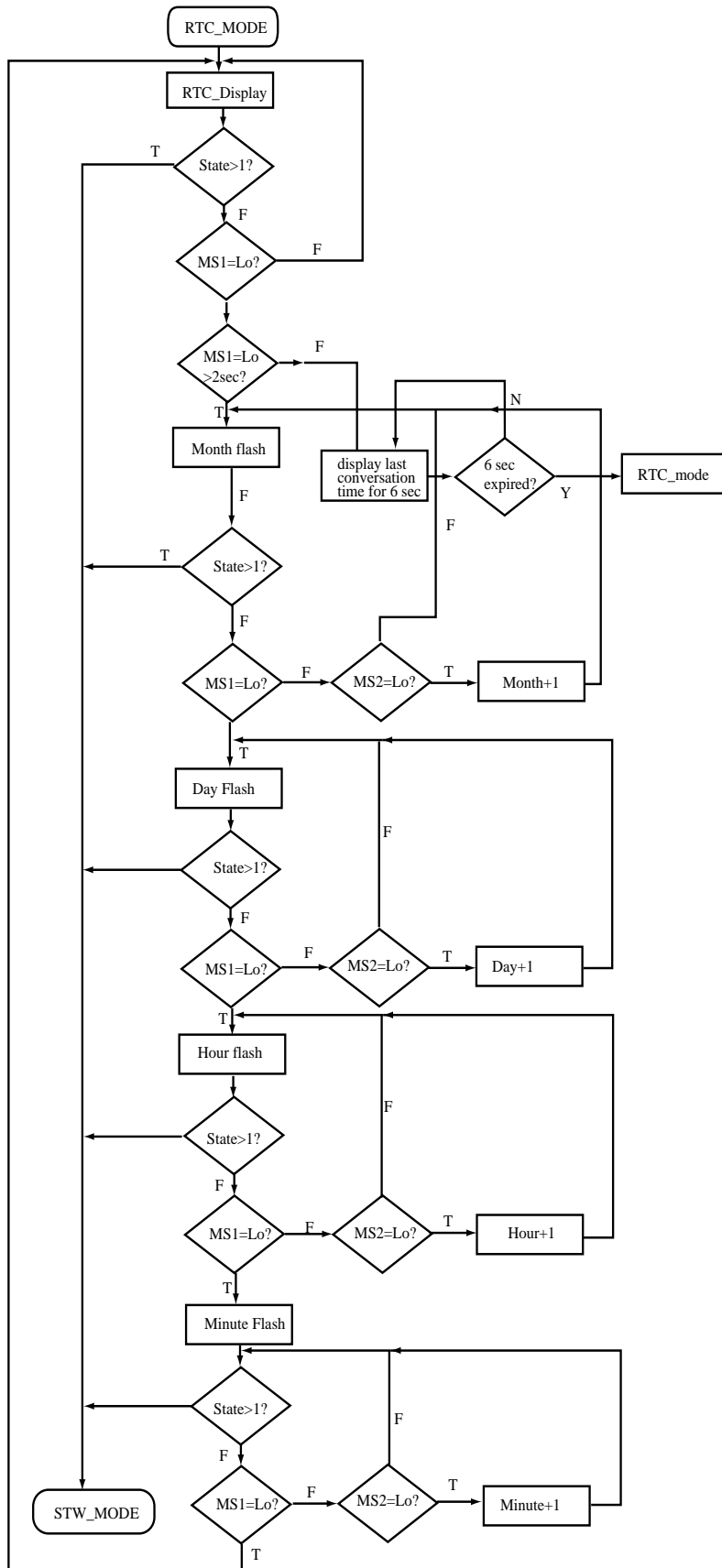

Figure 5 - RTC Flow Chart

Preliminary

Check last conversation time

When the system is at RTC mode, pressed MS1 less than 2 sec. The last conversation will show up on LCD screen to check the last conversation time.

Stop Watch mode

When the system exits from State 1 (RTC mode), it will enter Stop-watch mode which is intended to count elapsed telephone conversation time up to 59 minutes and 59 seconds and display dialing information such as dialing number, various indicators (MEMORY, RD, HOLD, Hand-Free, etc.) For example:

- Originally the system is in State 1, and the LCD panel is in RTC display mode.

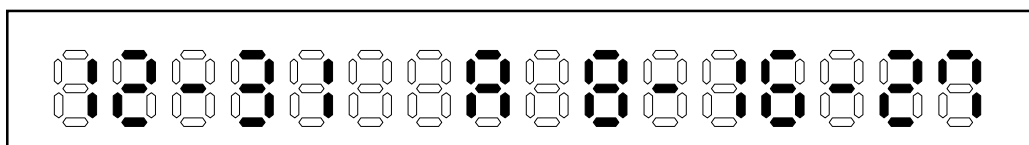

- When the HKS pin goes from "high" to "low". The LCD will be blanked.

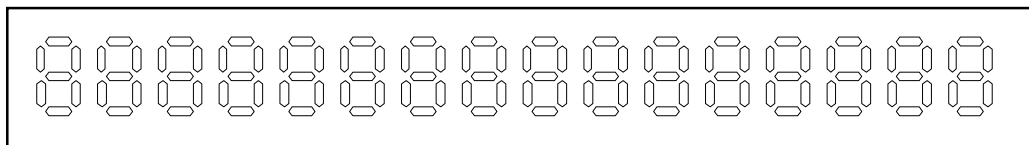

- After 2 sec, the system switches from State 1 to State 2, the stop watch will start counting from 00-00.

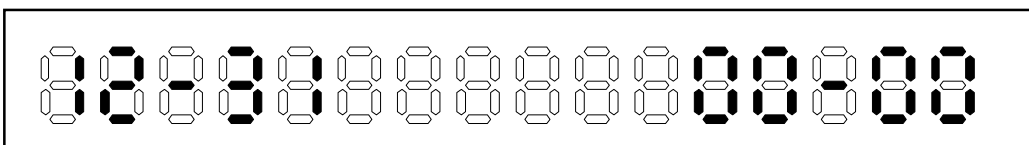

- After 59 minutes and 59 seconds, the stop-watch becomes 59-59.

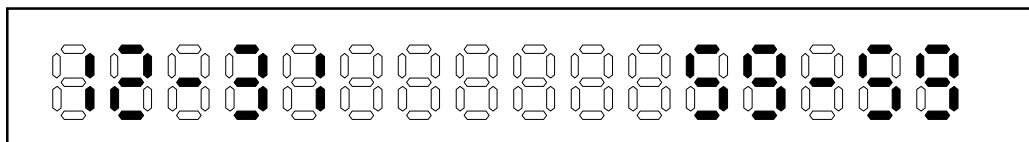

- Then stop-watch will wrap around and start from 00-00 again.

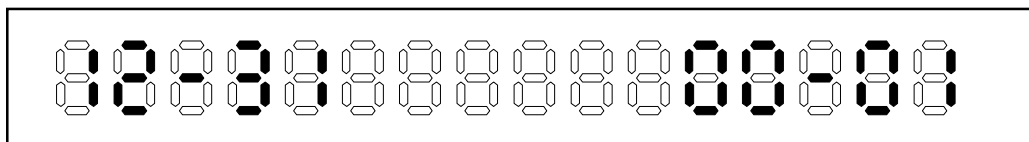
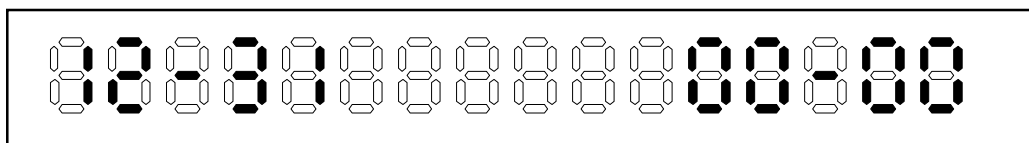

Preliminary

Stop-Watch reset and RTC display in Stop-watch Mode

The system will enter Stop-watch mode with stop watch automatically reset when the system first switches from State 1 to other States in the Stop-watch mode.

In addition, the stop-watch can be reset any time, e.g. when the called party answers, by pressing MS2 switch. For example:

- 21 seconds after the system enters Stop-watch mode, the display becomes 00-21.

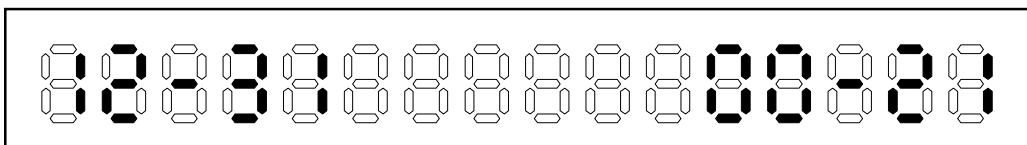

- When the other party answers, press MS2 key to reset the stop-watch. Then the stop-watch can reflect the real phone conversation time.
- When the system is in Stop-watch mode, the EM32117 can be switched to RTC display by pressing MS1.

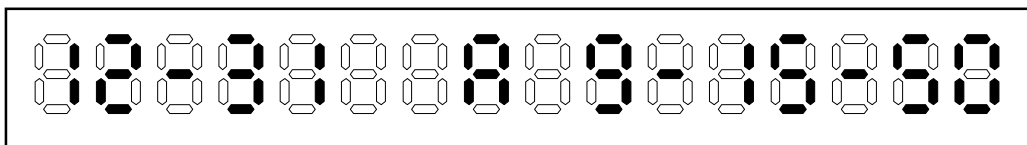

Dialing Number Display

When the system is in Stop-watch mode, each dialing digit data received from SDI pin of EM32117 will be decoded and appears at the right most digit on LCD panel and shifts left as each subsequent digit received until it is shifted out the panel at the left end. If no valid serial data is received for more than 6 seconds, the system will revert to stop watch display until a new digit are received from SDI pin. Display format is as follows:

- After HKS pin goes low, the EM32117 will enter Stop-watch Mode, after 2 sec blanking state.

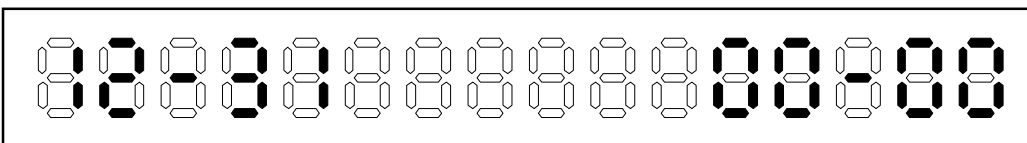

- When "035" are received from SDI pin, the EM32117 will switch to dialing number display.

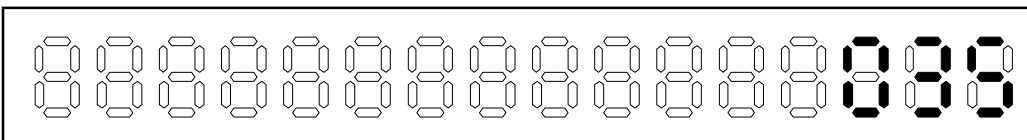

- After "787" are received, the LCD panel is as shown below:

Preliminary

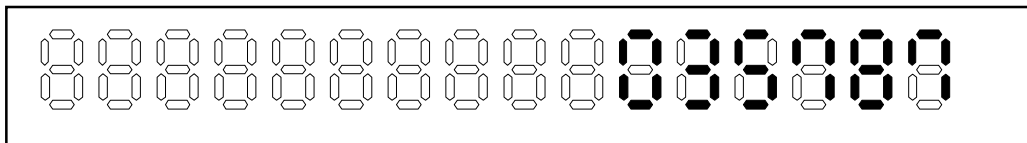

- Then "505" are received.

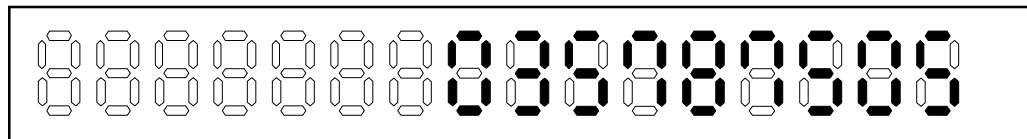

- Then "21912345" are received, the display is as follows:

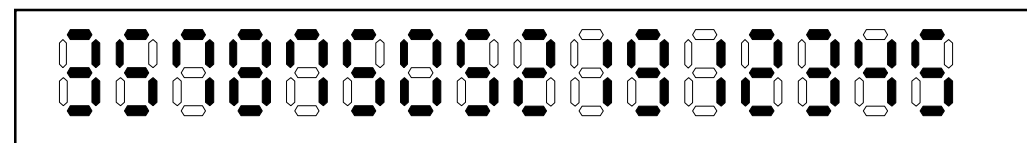

- 6 seconds after the last received digit, the EM32117 will go back to stop watch display.

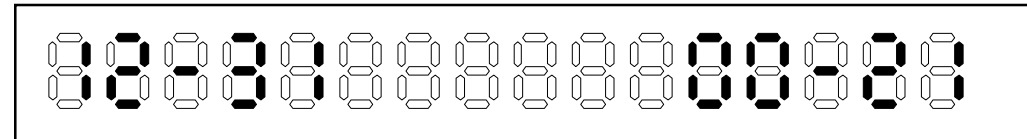

- When the system reverts to State 1 with ENRTC* at low level, the Stop-watch will stop counting and stay on the panel for 6 more seconds before it switches to RTC display. However, if ENRTC* is at high level when the system returns to State 1, the LCD panel will go blank immediately.

Please refer to the following flow chart for detailed information.

Stop watch delay :

The last conversation time will prevent to be destroyed by stop watch delay function. After off-hook (or turn on HF), STW will be displayed after 2 sec. This function is to prevent the user quickly ON-OFF HOOK to destroy the last conversation time data.

Preliminary

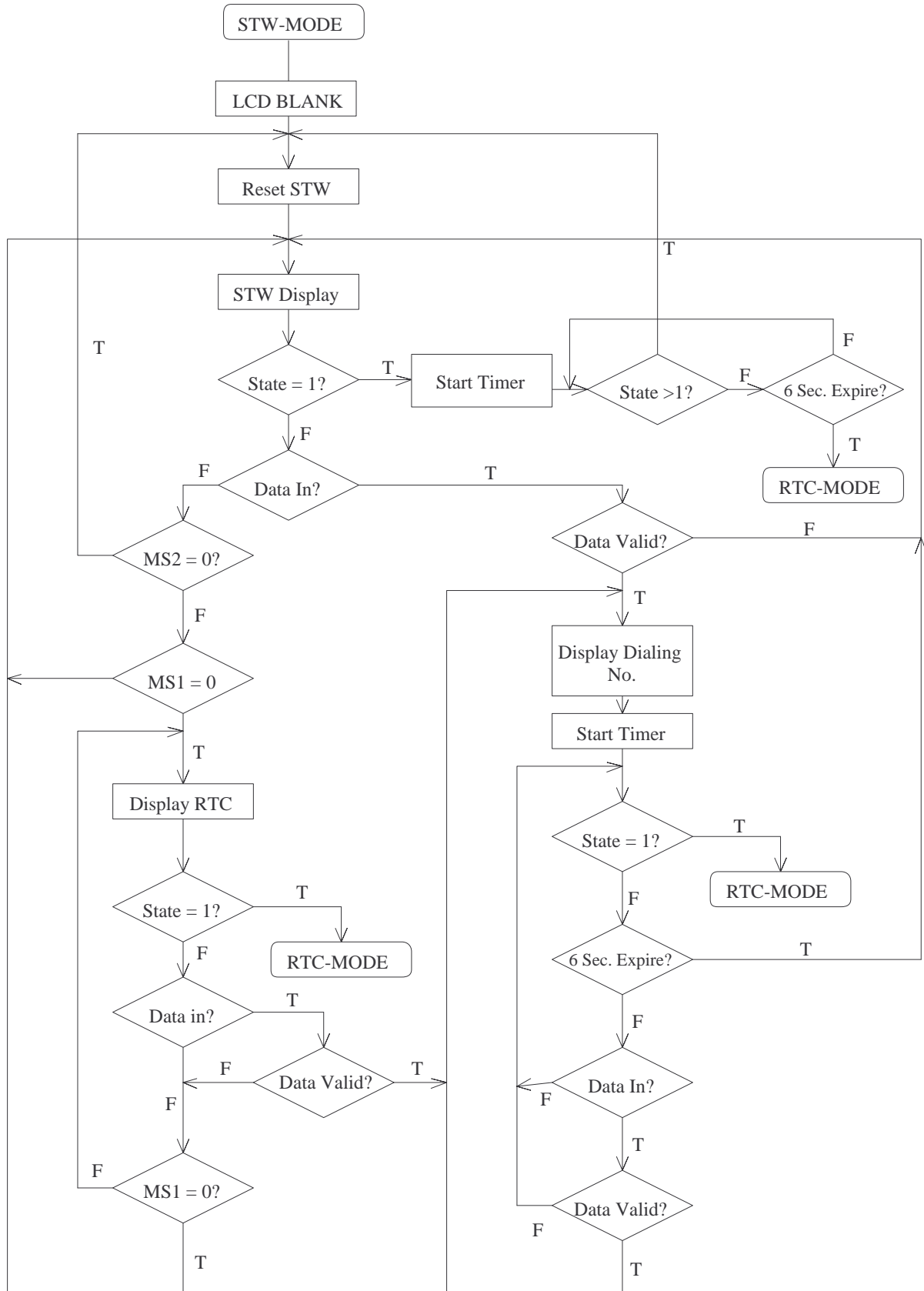

Figure 6 - Stop-watch mode flow chart

Preliminary

Displaying Indicators

When the received serial data correspond to indicators, depending on which group the indicators belong to, the responses to the data are different.

- If the contents of the data corresponds to either one of the SPEAKER, HOLD indicators, then the states of the indicators are governed by the state diagram in figure 4. As the state-diagram suggests, the indicators HOLD and SPEAKER are controlled by the status of HKS pin as well as Serial Data HOLD, and SPEAKER.

Operating state	HKS pin status	HOLD Indicator	SPEAKER Indicator
1. On-hook state	Hi	OFF	OFF
2. Off-hook state	Lo	OFF	OFF
3. Off-hook, HF state	Lo	OFF	ON
4. On-hook, HF state	Hi	OFF	ON
5. Off-hook, HD state	Lo	ON	OFF
6. On-hook, HD state	Hi	ON	OFF

- If the Serial Data received corresponds to one of Redial, Store, Auto, Page, Memory indicators for the first time after HKS pin switches from high to low, it will be interpreted as "turning-on the indicator". These indicators will remain on till 6 seconds after the last dialed number when the display mode switches from Dialing Number Display to Stop-watch display, then these indicators will go out.
- If the received Serial Data corresponds to the codes of MUTE or ALARM, then each receptions of the same serial data will be interpreted as "flipping (toggling) the current state of the indicator". However, when the system returns to state 1, the MUTE will also be cleared.

Driving a 12 digit LCD panel

When the EM32117 is driving a 12 digit LCD panel, the ENCnLD should be pulled to V_{DD} to suppress the display of calendar. For example,

- When the system is in State 1 (the LCD panel is at RTC mode), pulling ENCnLD to V_{DD} will disable display of calendar.

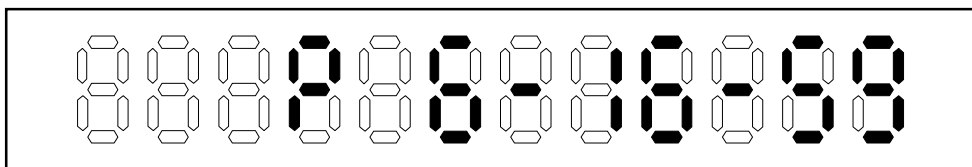

Note: Calendar display will be automatically suppressed when Real-Time Clock is disable (pulling ENRTC to high level).

Suppressing Real-Time Clock Display

With the ENRTC at high level (Real-Time Clock disabled) and the system is in State 1, the LCD panel will be blanked. While the system is in Stop-watch mode, it is not possible to switch to calendar and RTC mode by pressing MS1 key.

Preliminary

ABSOLUTE MAXIMUM RATINGS

Items	Sym.	Rating	Condition
Supply voltage	V_{DD}	- 0.5V to 5V	
Input voltage	V_{IN}	- 0.5V to $V_{DD} + 0.5V$	
Output voltage	V_O	- 0.5V to $V_{DD} + 0.5V$	Except open-drain
		-0.5 V to 5V	Open-drain
Power dissipation	P_D	300 mW	$T_{opr} = 50^\circ C$
Operating temperature	T_{OPR}	$0^\circ C$ to $50^\circ C$	
Storage temperature	T_{STR}	$-55^\circ C$ to $125^\circ C$	

RECOMMENDED OPERATING CONDITIONS

1. Supply voltage at 1.5 V D.C.
2. Operation frequency f_{osc} : 32768 Hz
3. Crystal don't need extra capacitor

DC AND AC ELECTRICAL CHARACTERISTICS ($f_{osc}=32768$ Hz; $V_{SS} = 1.50V$)

Parameter	Sym.	Min.	Typ.	Max.	Unit	Condition
Operating voltage	V_{DD}	1.2	1.5	1.6	V	
	V2	$2V_{DD} - 0.1$	$2V_{DD}$	$2V_{DD} + 0.1$	V	
	V3	$3V_{DD} - 0.15$	$3V_{DD}$	$3V_{DD} + 0.15$		
Operating current (no load)	I _{dd}	-	1	1.5	μA	
Input voltage (Input pins except HKS)	V _{iH}	$V_{DD} - 0.3$	-	V_{DD}	V	
	V _{iL}	V_{SS}	-	$V_{SS} + 0.3$	V	
Input pins pull-up optimal resistor (MS1, MS2, HKS pin)	R _{oiH}	-	1	-	MΩ	V _i switch from V_{DD} to V_{SS} and R _i switch from R _{oiL} to R _{oiH}
	R _{oiL}	-	100	-	KΩ	
SDI pin input resistance	R _i	-	150	-	KΩ	V _i = V_{SS}
Oscillator frequency	f_{osc}	-	32768	-	Hz	
Oscillator start time Common/Segment pins	T _{start}	-	-	2	Sec.	$V_{DD} = 1.3V$
HKS pin input voltage	V _{iH}	$V_{DD} - 0.2V$	-	V_{DD}	V	
	V _{iL}	V_{SS}	-	$V_{SS} + 0.2$	V	
HKS, MS1, MS2, input pin debouce time	T _{db}	-	20	-	mS	
Crystal input and output pin built-in capacitor	C _o	-	20	-	pF	

Preliminary

APPLICATION CIRCUIT

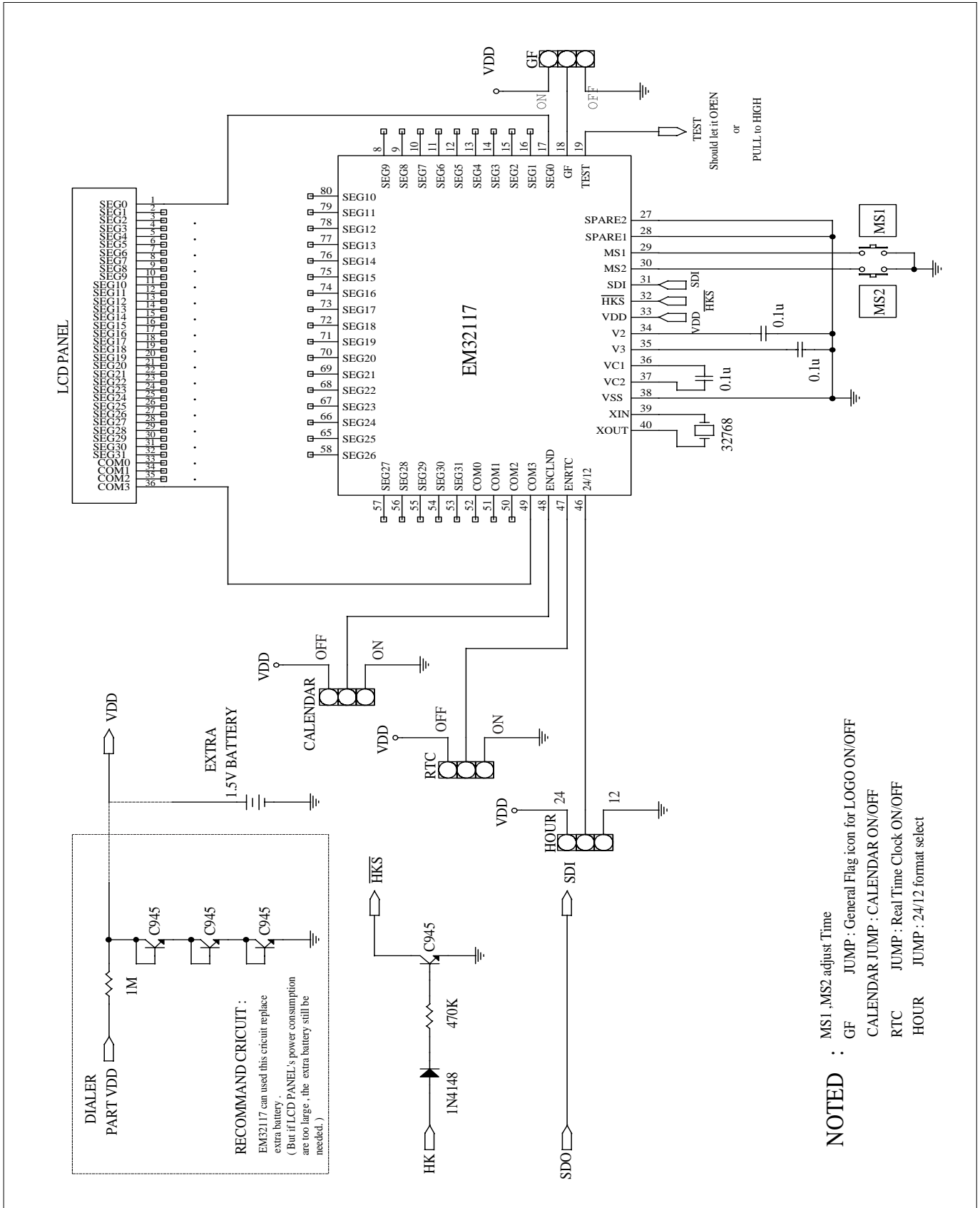

* This specification are subject to be changed without notice.

Preliminary

PAD DIAGRAM

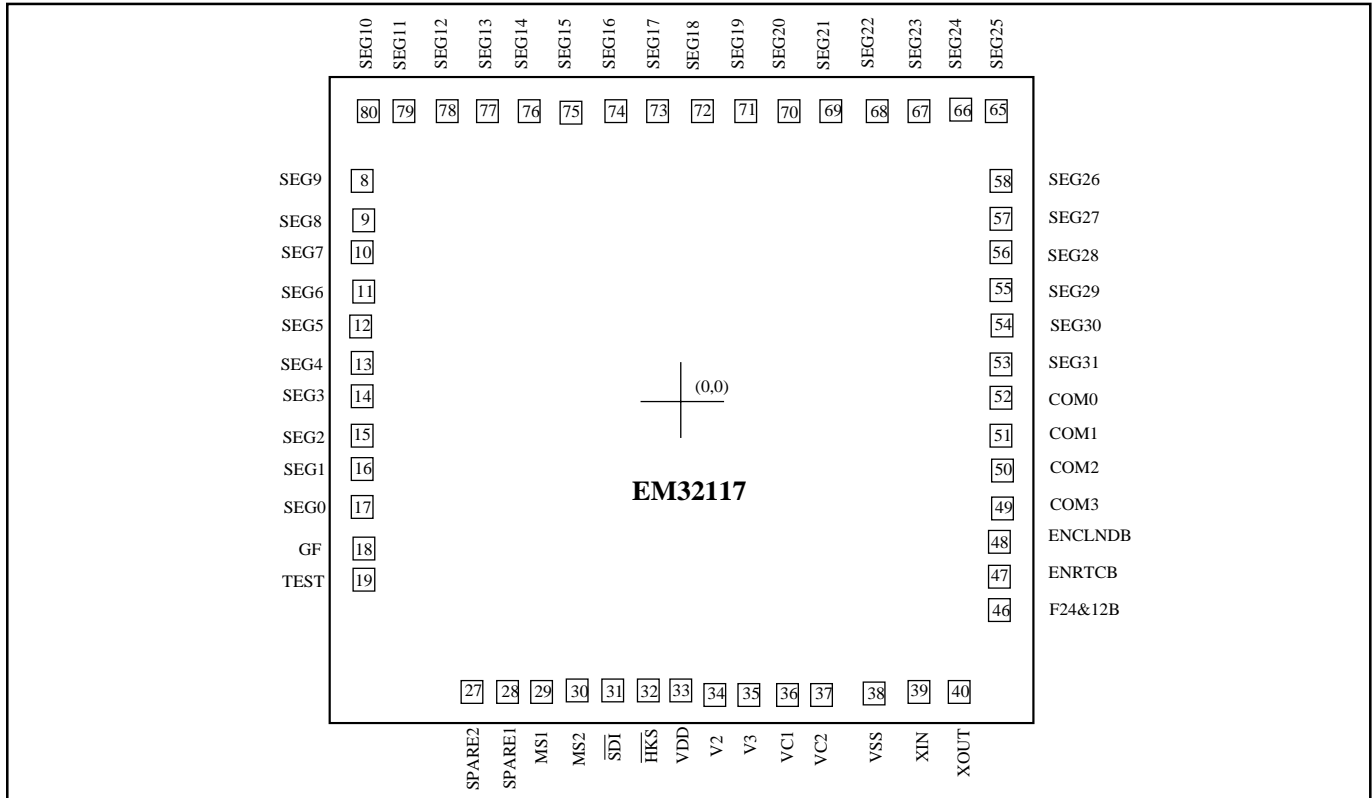

Chip Size : 2450 x 2130 μm

Pad No.	Symbol	X	Y
8	SEG9	-1093.3	666.6
9	SEG8	-1093.3	525.5
10	SEG7	-1093.3	399.2
11	SEG6	-1093.3	258.1
12	SEG5	-1093.3	132.1
13	SEG4	-1093.3	-9.0
14	SEG3	-1093.3	-135.0
15	SEG2	-1093.3	-276.1
16	SEG1	-1093.3	-402.1
17	SEG0	-1093.3	-543.1
18	GF	-1108.3	-669.1
19	TEST	-1108.3	-795.1
27	SPARE2	-1083.1	-932.2
28	SPARE1	-955.0	-932.2
29	MS1	-823.4	-932.2
30	MS2	-695.3	-932.2
31	$\overline{\text{SDI}}$	-569.3	-932.2
32	$\overline{\text{HKS}}$	-437.7	-932.2
33	V_{DD}	-311.7	-936.1
34	V2	-185.7	-936.1
35	V3	-59.7	-940.6
36	VC1	68.5	-936.1

* This specification are subject to be changed without notice.

**Preliminary**

Pad No.	Symbol	X	Y
37	VC2	196.6	-941.4
38	V _{ss}	322.6	-931.3
39	XIN	448.6	-931.3
40	XOUT	621.6	-935.2
46	24/12	1099.3	-945.9
47	ENRTC	1099.3	-819.9
48	ENCLND	1099.3	-693.9
49	COM3	1089.8	-552.2
50	COM2	1089.8	-410.5
51	COM1	1089.8	-284.5
52	COM0	1089.8	-144.2
53	SEG31	1089.8	-18.2
54	SEG30	1089.8	122.9
55	SEG29	1089.8	248.9
56	SEG28	1089.8	390.0
57	SEG27	1089.8	516.0
58	SEG26	1089.8	657.1
65	SEG25	1081.7	929.6
66	SEG24	929.5	929.6
67	SEG23	788.3	929.6
68	SEG22	661.3	929.6
69	SEG21	520.2	929.6
70	SEG20	380.2	929.6
71	SEG19	210.6	929.6
72	SEG18	72.3	929.6
73	SEG17	-83.5	929.6
74	SEG16	-221.8	929.6
75	SEG15	-377.6	929.6
76	SEG14	-512.5	929.6
77	SEG13	-660.6	929.6
78	SEG12	-788.4	929.6
79	SEG11	-929.5	929.6
80	SEG10	-1085.4	929.6

Preliminary

12 DIGITS LCD PANEL DESIGN NOTE

LCD Panel Description

The 12 digits LCD display font of the EM32117 LCD driver is shown as the following :

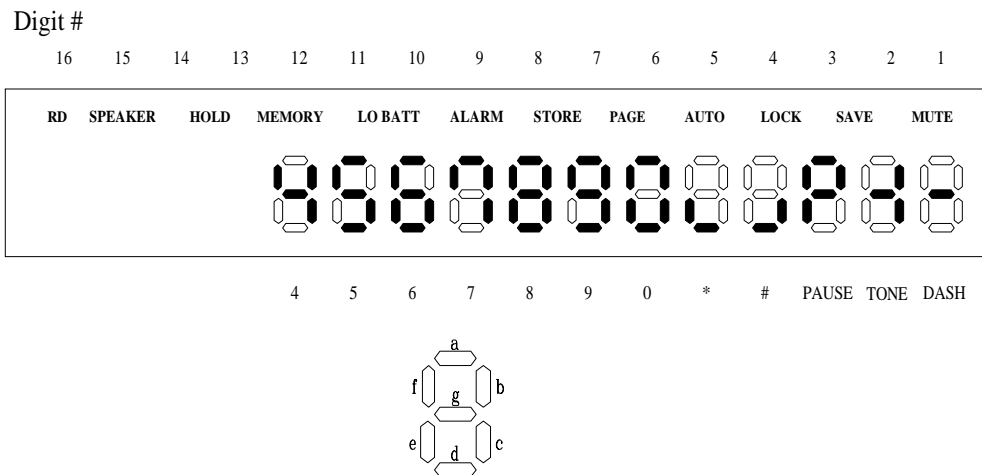

	SEG23	SEG22	SEG21	SEG20	SEG19	SEG18	SEG17	SEG16
COM3	12f	12a	11f	11a	10f	10a	9f	9a
COM2	12g	12b	11g	11b	10g	1b	9g	9b
COM1	12e	12c	11e	11c	10e	10c	9e	9c
COM0	12d	RD	11d	Speaker	10d	HOLD	9d	Memory

	SEG15	SEG14	SEG13	SEG12	SEG11	SEG10	SEG9	SEG8
COM3	8f	8a	7f	7a	6f	6a	5f	5a
COM2	8g	8b	7g	7b	6g	6b	5g	5b
COM1	8e	8c	7e	7c	6e	6c	5e	5c
COM0	8d	GF	7d	ALARM	6d	STORE	5d	PAGE

	SEG7	SEG6	SEG5	SEG4	SEG3	SEG2	SEG1	SEG0
COM3	4f	4a	3f	3a	2f	2a	1f	1a
COM2	4g	4b	3g	3b	2g	2b	1g	1b
COM1	4e	4c	3e	3c	2e	2c	1e	1c
COM0	4d	AUTO	3d	LOCK	2d	SAVE	1d	MUTE

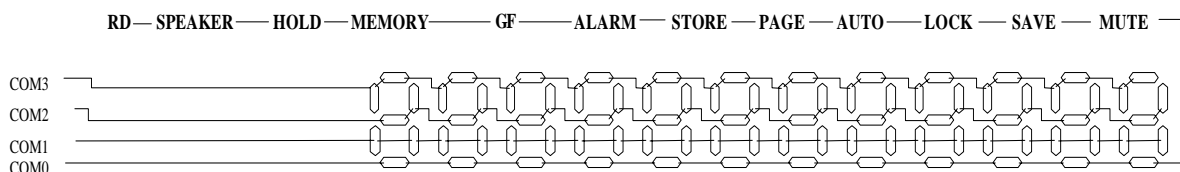

Preliminary

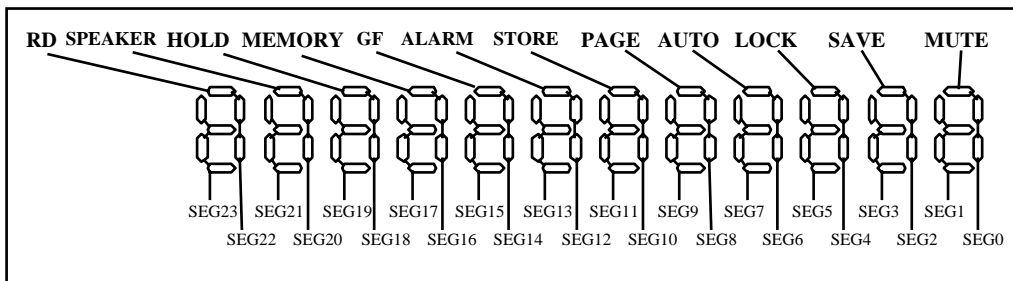
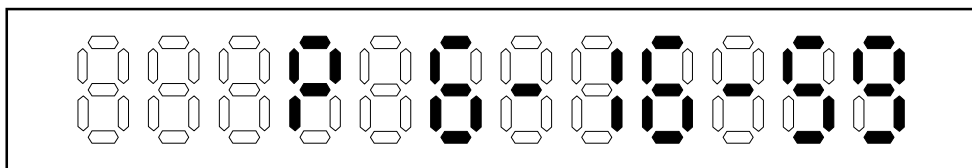

Figure 2 - Segment pin wiring diagram

Driving a 12 digit LCD panel

When the EM32117 is driving a 12 digit LCD panel, the ENCnLD should be pulled to V_{DD} to suppress the display of calendar. For example,

- When the system is in State 1 (the LCD panel is at RTC mode), pulling ENCnLD to V_{DD} will disable display of calendar.



Note: Calendar display will be automatically suppressed when Real-Time Clock is disable (pulling ENRTC to high level).

Preliminary

PAD DIAGRAM

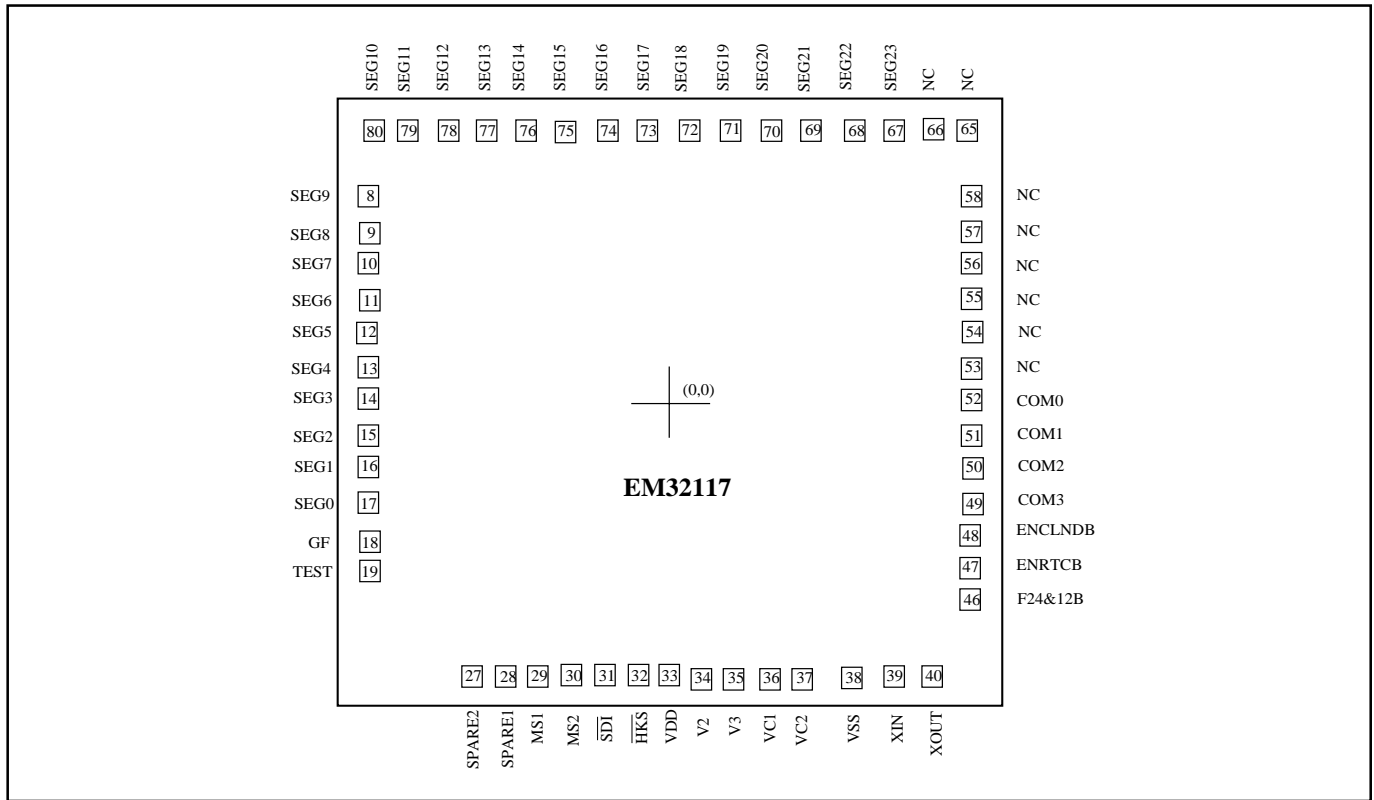

Chip Size : 2450 x 2130 μm

Pad No.	Symbol	X	Y
8	SEG9	-1093.3	666.6
9	SEG8	-1093.3	525.5
10	SEG7	-1093.3	399.2
11	SEG6	-1093.3	258.1
12	SEG5	-1093.3	132.1
13	SEG4	-1093.3	-9.0
14	SEG3	-1093.3	-135.0
15	SEG2	-1093.3	-276.1
16	SEG1	-1093.3	-402.1
17	SEG0	-1093.3	-543.1
18	GF	-1108.3	-669.1
19	TEST	-1108.3	-795.1
27	SPARE2	-1083.1	-932.2
28	SPARE1	-955.0	-932.2
29	MS1	-823.4	-932.2
30	MS2	-695.3	-932.2
31	SDI	-569.3	-932.2
32	HKS	-437.7	-932.2
33	VDD	-311.7	-936.1
34	V2	-185.7	-936.1
35	V3	-59.7	-940.6
36	VC1	68.5	-936.1

* This specification are subject to be changed without notice.



Preliminary

Pad No.	Symbol	X	Y
37	VC2	196.6	-941.4
38	Vss	322.6	-931.3
39	XIN	448.6	-931.3
40	XOUT	621.6	-935.2
46	24/12	1099.3	-945.9
47	ENRTC	1099.3	-819.9
48	ENCLND	1099.3	-693.9
49	COM3	1089.8	-552.2
50	COM2	1089.8	-410.5
51	COM1	1089.8	-284.5
52	COM0	1089.8	-144.2
53	NC	1089.8	-18.2
54	NC	1089.8	122.9
55	NC	1089.8	248.9
56	NC	1089.8	390.0
57	NC	1089.8	516.0
58	NC	1089.8	657.1
65	NC	1081.7	929.6
66	NC	929.5	929.6
67	SEG23	788.3	929.6
68	SEG22	661.3	929.6
69	SEG21	520.2	929.6
70	SEG20	380.2	929.6
71	SEG19	210.6	929.6
72	SEG18	72.3	929.6
73	SEG17	-83.5	929.6
74	SEG16	-221.8	929.6
75	SEG15	-377.6	929.6
76	SEG14	-512.5	929.6
77	SEG13	-660.6	929.6
78	SEG12	-788.4	929.6
79	SEG11	-929.5	929.6
80	SEG10	-1085.4	929.6