



Preliminary

GENERAL DESCRIPTION

The EMPCD200 is a single-chip LS1 CMOS calculator for 3 sets store memory (14-digits or 16-digits). Besides, the EMPCD200 is an arithmetic four standard types of general function (+, -, \times , \div), TAX function, Euro & 5 sets currency exchange, percentage calculation functions, leading zero and trailing zero suppression, chain calculations, Mark up/down (MU/MD) & Delta percent ($\Delta\%$) calculation, Grand Total (GT) calculation, Auto Power OFF available, 14/16-digit selectable LCD display. Dual power supply operation, wide operating voltage, and lower power consumption make it suitable for 1.5 solar battery operated calculator.

FEATURES

- Number of display 14 /16 digits of data, (including punctuation in each digit)
1-digit of floating minus sign, memory I (M) & memory II (MII) load symbol, error symbol, 3-digits of commas for thousands, TAX symbol, currency exchange (Local, Euro, C1~C5) symbol, GT and sing symbol, etc.
- Operation methods By algebraic operation.
- Basic operations Four function, repeat multiplication and division, mixed calculation, square calculation, percentage calculation, percent discount and add-on / discount calculation, memory calculation, delta percent calculation, add-mode calculation, mark-up / down calculation, Grand total calculation, constant calculation, TAX calculation, EURO exchange, currency exchange and square root calculation.
- Decimal point method Decimal set lock key controls output format. Fixed decimal setting ("0", "1", "2", "3", "4", "5", "6"), full floating decimal, and ADD mode (selectable with a switch).
- Contents of operation
 1. Floating point mode during operation and key entry that specified only Addition and Subtraction.
 2. Specified decimal point mode is valid only for operation results.
 3. Round-off when most significant digits have higher priority or at auto shift of rough estimation.
- Key rollover method Two-key rollover

Preliminary

- Error detect display
 1. Key entry exceeding the number of display digits is invalid, but does not cause an error.
 2. If the integer part of an operation result exceeds the number of display digits, a rough estimate is displayed.
 3. In the overflow condition, all key except “C”, “C/CE”, “CE”, “→” keys are inoperative.
- Protection
 1. In the overflow condition, all key except “C”, “C/CE”, “CE”, “→” keys are inoperative.
 2. Key chatter protection.
 3. Auto-clear at power on
Auto-clear functions by connecting a capacitor to the RESET pin.
5 minutes
- Auto power off function
- Clock source
Oscillator / clock generator internal to chip.
- Others
 1. Keyboard encoding internal to chip.
 2. Wide supply voltage range (1.2 to 1.8V).
 3. Very low power consumption.
 4. Battery / solar power supply.
 5. Symbol blinking available.
 6. Rate will be kept after AC key pressed.



Preliminary

PIN DESCRIPTIONS

SYMBOL	I/O	FUNCTION
COM1~3	O	LCD Common signal output.
A1	O	LCD Segment signal output and strobe output for switch status.
B1	O	LCD Segment signal output and strobe output for switch status.
C1	O	LCD Segment signal output and strobe output for switch status.
A2	O	LCD Segment signal output and strobe output for switch status.
B2	O	LCD Segment signal output and strobe output for switch status.
C2	O	LCD Segment signal output and strobe output for switch status.
A3	O	LCD Segment signal output and strobe output for switch status.
B3	O	LCD Segment signal output and strobe output for switch status.
C3	O	LCD Segment signal output.
A4 ~ A16	O	LCD Segment signal output.
B4 ~ B16	O	LCD Segment signal output.
C4 ~ C16	O	LCD Segment signal output.
D1 ~ D6	O	LCD Segment signal output.(for symbols or icons display)
VDD,VSS	---	Positive and negative power supply pin.
VA,VB	---	Voltage double for LCD connects a capacitor (0.1uF) between both pins.
VEE	---	LCD voltage from voltage double connects a capacitor (0.1uF) to pin VDD.
TS1	I	Test pin input, be opened.
RESET	I	System reset / AC key input. (built-in schmitt trigger for debouncing)
K0 ~ K2	O	Keyboard polling signal output pins.
K3 ~ K7	I/O	Keyboard polling signal output and strobe input pins.
K8 ~ K10	I	Keyboard strobe input pins.
K11~K14	I	Switch status strobe input pins.

Preliminary

Function Descriptions

A). Operation Characteristics

- Constant Operation

The EMPCD200 has implied constant mode on +, -, ×, ÷ and % operations. The constant is performed automatically by the "=" key, "%=" key, or "%=" key without a constant for addition and division while the first operand is the constant for multiplication.

- Number Entry

Numerical can be entered up to 16 digit.

- Memory Protection

In any error detection, the memory contents present before the error detection are protected.

- Memory Indication

If the memory contents are a number other than zero, "M" is indicated in the sign-digit position.

B). Keyboard Description

- Off key (OFF)

Turn off the power.

- Resume key (RESUME)

A push will power on the calculation. Keep calculate state before power off.

- Clear key (C)

During the digit entry, the first depression will clear all except memory contents.

- Clear Entry key (CE)

During the digit entry will clear the entry register and display number "0".

- Clear & Clear Entry key (C/CE)

i). During the digit entry will clear the entry register and display number "0".

ii). Other will clear all except memory contents.

- Number, Decimal key ("000", "00", "0 – 9", "•")

The first number key in a sequence will clear the display and enter the digit in the display. Successive entries will shift the display left and enters the data in display register. The first decimal point entered is effective. An attempted entry of more than 15 digits or 17 decimal places will be ignored.

- Change Sign key (+/-)

Pushing the "+/-" key twice in succession causes the corresponding sign to appear and disappear. During digit entry, this function changes the sign of the entered factor.

- Reverse (RV)

Reverse dividend.

Preliminary

- Shift Key (\rightarrow)
 - i). Delete the rightist digit and others will shift to right.
 - ii). Rate setting mode, to recall and select pre-registered exchange rate value(s).
- Multiplication Key (\times)
 - i). Enters multiplicand.
 - ii). Performs previous operation and displays result.
- Division Key (\div)
 - i). Enters dividend.
 - ii). Performs previous operation and displays result.
- Addition Key (+)
 - i). Conditions machine for an addition.
 - ii). Performs previous operation and displays result.
- Subtraction Key (-)
 - i). Conditions machine for a subtraction.
 - ii). Performs previous operation and displays result.
- Equal Key (=)
 - i). Performs Keyed-in operation and maintains that operation for possible use.
 - ii). Establishes power/reciprocation calculation.
- Percent key (%)

The purpose of the percent key is to allow for calculation of add-on and discount. Determination of add-on requires the principal amount to be the first entry followed by the "+" or "-" key, with the percentage being the second entry. Depression of the percent key yields the amount to add on, such as tax or interest. Depression of the "=" key adds this amount to the principal.
- Square Root Key ($\sqrt{}$)

Extract the square root of a positive numeric displayed in the entry register.
- Memory I & II Plus Key (M+ & MII+)
 - i). Adds the current display to the contents of memory.
 - ii). It will terminate a number entry.
- Memory I & II Minus Key (M- & MII-)
 - i). Subtracts the current display from the contents of memory
 - ii). It will terminate a number entry.
- Clear memory I & II key (CM & CMII)
 - i). Recall and clear the contents of memory.
 - ii). The recalled number is displayed and printed without rounding.
- Recall memory I & II key (RM & RMII)
 - i). Recall the contents of memory and memory is kept.
 - ii). The recalled number is displayed and printed without rounding or zero suppress.



Preliminary

- Recall & Clear memory I & II key (RCM & RCMII)
 - i). First pressed as RM key, transfers the contents of the memory register into the display register.
 - ii). Second pressed as CM key, clear the memory.
- GT memory Recall and Clear key (RC GT)
 - i). First pressed as RGT key, transfers the contents of the GT memory register into the display register.
 - ii). Second pressed as CGT key, clear the GT memory.
- Grand Total (GT+)
Add the current display to the content of grand total memory.
- Grand Total (GT-)
Substrate the current display from the content of grand total memory, GT- will terminate a number entry.
- Mark-up/down & Delta percent key (MU/MD & Δ %)
 - i). First press (MU) key, execute Mark-up calculation by $A (\times) B$ (MU).
 - ii). First press (MD) key, execute Mark-down calculation by $A (\div) B$ (MU [MD]).
 - iii). Second press (MU/MD) key, to calculate the mark-up/down percent value.
 - iv). Execute Delta-percent calculation by $A (+ \text{ or } -) B$ (MU [Δ %]).
- Delta Percent key (Δ % key)
 - i). Execute Increase ratio calculation by $A (\times) B (\Delta \%)$.
 - ii). Execute Decrease ratio calculation by $A (\div) B (\Delta \%)$.
- Rate key (RATE)
To start inputting the TAX rate, the Euro exchange rate or the Currency (C1~C5) exchange rate.
- TAX-including key (TAX+)
 - i). When immediately after [RATE] key, store displayed number in TAX memory.
 - ii). Execute TAX-including calculation of displayed number, TAX rate is in TAX memory.
 - iii). In the halfway of four rules of arithmetic, TAX-including calculation don't break the intermediate result, so TAX-including is used in expression.
 - iv). When pressed just after the TAX-including calculation to calculate the TAX value when pressed just after the first press.
- TAX-excluding key (TAX-)
 - i). When immediately after [RATE] key, recall displayed number in TAX memory.
 - ii). Execute TAX-excluding calculation of displayed number, TAX rate is in TAX memory.
 - iii). In the halfway of four rules of arithmetic, TAX-excluding calculation don't break the intermediate result, so TAX-excluding is used in expression.
 - iv). When pressed just after the TAX-excluding calculation to calculate the TAX value when pressed just after the first press.

Preliminary

- EURO-conversion key (EURO)
 - i). Execute EURO-conversion of displayed number, conversion rate is in EURO memory.
 - ii). In the halfway of four rules of arithmetic, EURO-conversion doesn't break the intermediate result, so EURO-conversion is used in expression.
 - iii). When immediately after [RATE] key, store displayed number in EURO memory.
- Local-conversion key (LOCAL)
 - i). Execute Local-conversion of displayed number, conversion rate is in EURO memory.
 - ii). In the halfway of four rules of arithmetic, Local-conversion doesn't break the intermediate result, so Local-conversion is used in expression.
 - iii). When immediately after [RATE] key, recall displayed number in EURO memory.
- 2nd key (2nd)
 - i). Toggle enable/disable 2nd mode.
 - ii). Indicates that (2nd) key has been pressed. Pressing another (C1~C5) key in succession, to which the currency exchange function is assigned, performs the function.

Selection Mode Switch Functions

14-digit / 16-digit modes depend on selectable switch. Fixed/floating decimal point mode and ADD mode are selected by rounding switch. The rounding switch should be so composed that either one of 6, 5, 4, 3, 2, 1, 0, ADD is selected.

- Fixed "F" mode
When TAB "F" is selected, both entered numbers and calculation results follow to floating decimal point system.
- DP $i = 0, 1, 2, 3, 4, 5, 6$ mode
The calculation results follow to fixed decimal point system and $i + 1$ decimal place is counted by "UP", "CUT" and "5/4".
- ADD mode
When "+" and "-" operation are performed after a number except decimal point is entered. The calculation is executed as $1/100$ value of number being entered.
- Fixed "UP" mode
The number of $i + 1$ decimal position is counted as round up away.
- Fixed "CUT" mode
The number of $i + 1$ decimal position is counted as cutting away.
- Fix "5/4" mode
When a number of $i + 1$ decimal position is more than 0.5, the number of i decimal position is counted as added to "1".

Preliminary

- GT off mode
Grand Total disable.
- GT on mode
Grand Total enable.
- Rate set mode
To start inputting the TAX rate, the Euro exchange rate or the Currency (C1~C5) exchange rate.
- 2nd mode
Pressing another (C1~C5) key in succession, to which the currency exchange function is assigned, performs the function,

Error Conditions

(a) Error Detection

System errors occur when:

- i) The division by zero.
- ii) The integral part of any memory calculation results exceeds 14 (16) digits.
- iii) Rough estimate calculation error.
- iv) The integral part of any calculation-four standard function, %, or power calculation result exceeds 14 digits (16 digits)

(b) Error Indication

i) System error:

System error:

ii) Rough estimate calculation error

iii) The high-order 14 digits (16 digits) of any calculation result is indicated with "E" sign and the decimal point is displayed at the position corresponding to 10^{-14} (10^{-16}) of the calculation result also on zero shift is performed.

(c) Error Release

System error:

A system error can be released by depressing ON/AC key or CE/C key. However, the calculation result is not cleared by CE/C key but is retained.

Overflow Condition

- (1) When the integer part of result exceed 14 digits (or 16 digits), the display will show 14 most significant digits of result divide by " 10^{+14} " (" 10^{+16} ") and "E".
- (2) When an overflow occurs on the way of add-on/discount calculation, display will show a zero and "E".
- (3) When the integer part of result exceeds 14 digits (or 16 digits), display will show a zero and "E".

Preliminary

- (4) When division by zero is attempted, an overflow condition will result, and error symbol "E" and a zero are displayed.
- (5) When the integer part of result in memory register exceeds 14 digits (or 16 digits) at memory calculation, display will show a zero and "E", and previous data will be kept in memory register.
- (6) In overflow condition, any operation or numeral entry will be inhibited.

LCD Panel Description

The EMPCD200 can directly voltage 3V and drive 16-digit 1/3 duty and 1/2 bias LCD panel.

The following tables exhibit the relationship between the LCD segment, and common pins and corresponding pattern on the display.

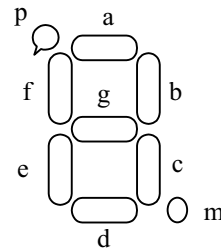

LCD Table

SEG				A1	B1	C1	D1	A2	B2	C2	D2	A3	B3	C3	D3
COM1	COM1			b1	a1	f1	C1	b2	a2	f2	C5	b3	a3	f3	RATE
COM2		COM2		c1	g1	e1	C2	c2	g2	e2	Euro	c3	g3	e3	% "T"
COM3			COM3	m1	d1	2nd	C3	m2	d2	C4	Local	m3	d3	p3	X

SEG	A4	B4	C4	D4	A5	B5	C5	D5	A6	B6	C6	D6	A7	B7	C7
COM1	b4	a4	f4	TAX	b5	a5	f5	M	b6	a6	f6	G	b7	a7	f7
COM2	c4	g4	e4	+ "T"	c5	g5	e5	-	c6	g6	e6	III	c7	g7	e7
COM3	m4	d4	p4	- "T"	m5	d5	p5	E	m6	d6	p6	X	m7	d7	p7

SEG	A8	B8	C8	A9	B9	C9	A10	B10	C10	A11	B11	C11	A12	B12	C12
COM1	b8	a8	f8	b9	a9	f9	b10	a10	f10	b11	a11	f11	b12	a12	f12
COM2	c8	g8	e8	c9	g9	e9	c10	g10	e10	c11	g11	e11	c12	g12	e12
COM3	m8	d8	p8	m9	d9	p9	m10	d10	p10	m11	d11	p11	m12	d12	p12

SEG	A13	B13	C13	A14	B14	C14	A15	B15	C15	A16	B16	C16
COM1	b13	a13	f13	b14	a14	f14	b15	a15	f15	b16	a16	f16
COM2	c13	g13	e13	c14	g14	e14	c15	g15	e15	c16	g16	e16
COM3	m13	d13	p13	m14	d14	p14	m15	d15	p15	m16	d16	X

Preliminary

- LCD Panel outlines drawing

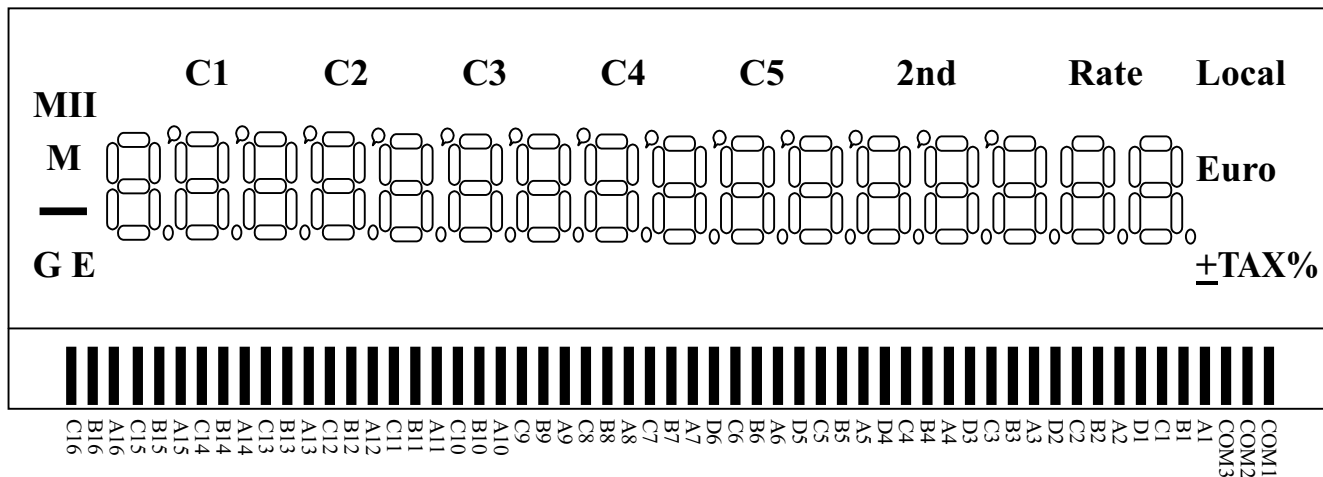

- LCD Segment

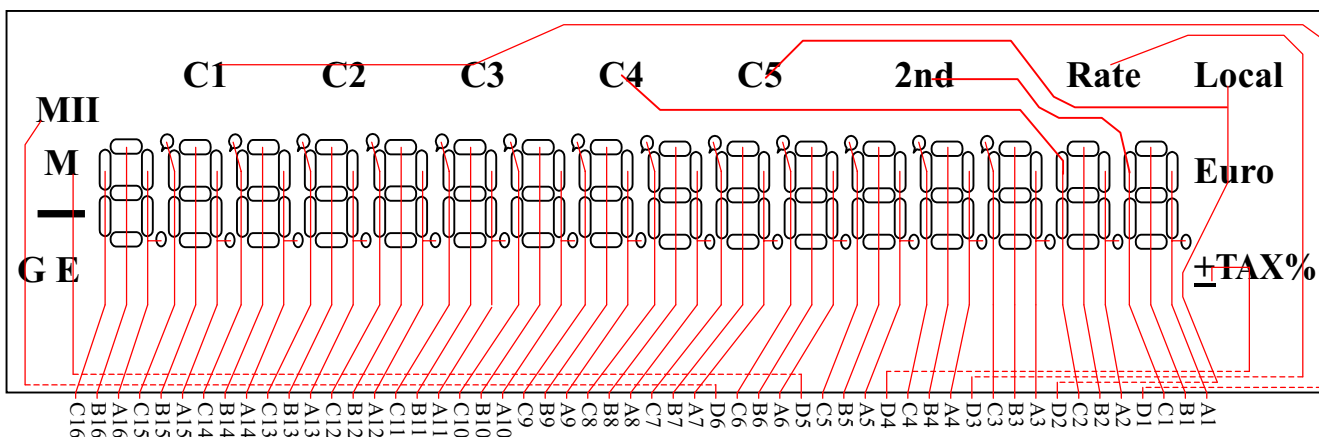

- LCD Common

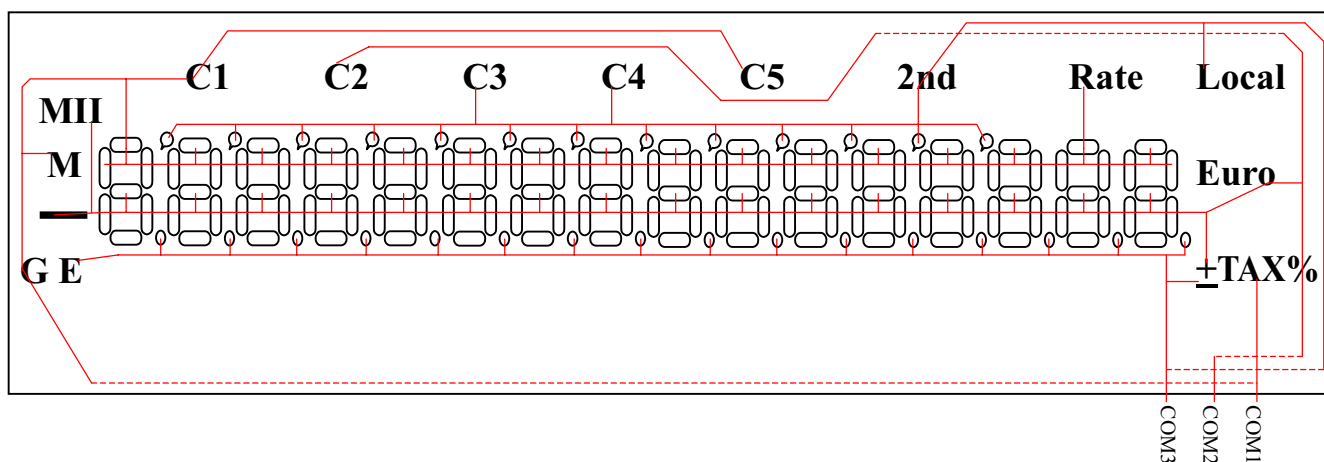

Preliminary

CONNECTION OF KEYBOARD

- Keyboard arrangement

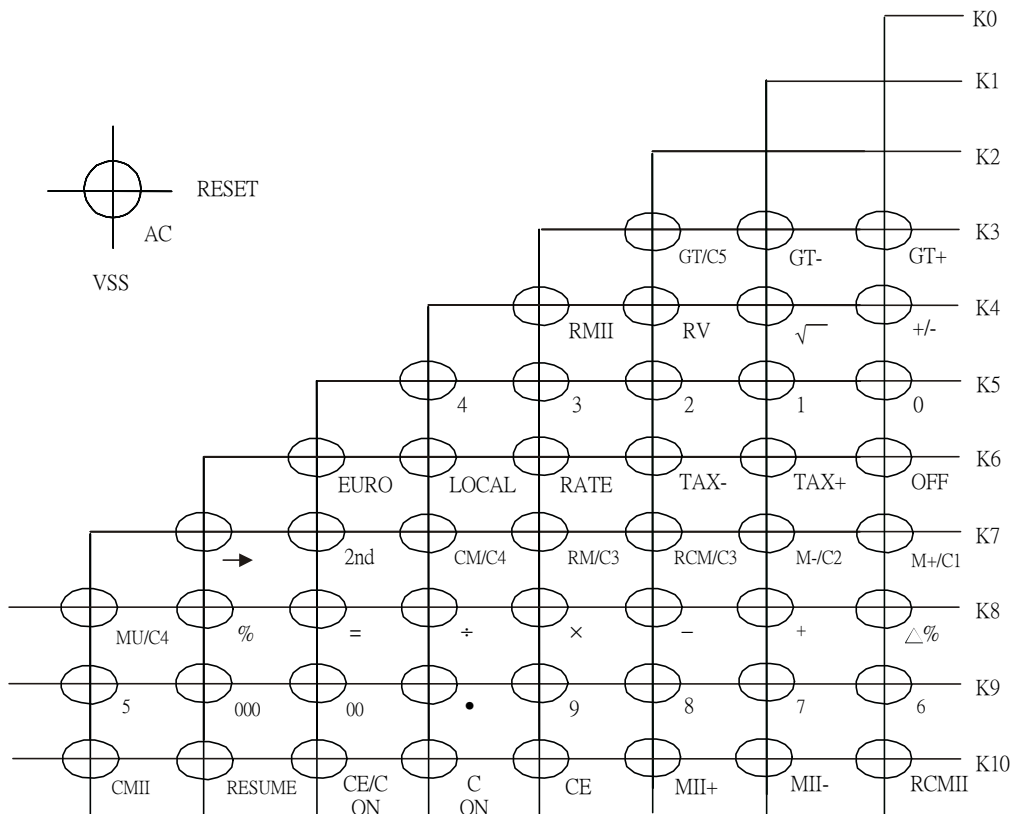

- Connection of switch

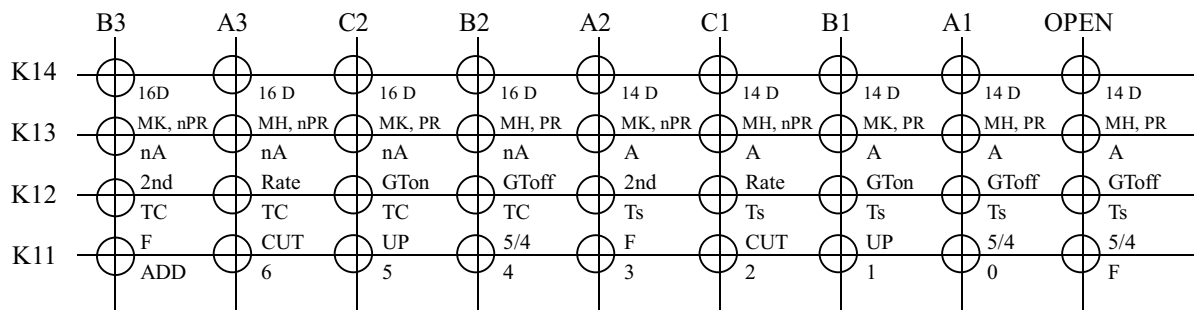

K14: Select with Calculated Digits (14 digit or 16 digit) and Memory Hold Status, MH (Memory Hold), MK (Memory Kill) at Auto Power OFF or OFF key and Pre-Rate value selection nPR (Pre-Rate disable), PR (Pre-Rate enable).



Preliminary

K13: Select with Auto Power OFF mode and Grand total on/off, Rate or 2nd switch.

K12: Select with TAX symbol option and Rounding switches or floating mode (F, CUT, UP, 5/4).

TC: TAX("TAX"), TAX+("TAX" and "+"), TAX-("TAX" and "-"), TAX%("TAX" and "%");

Ts: TAX("TAX"), TAX+("+"), TAX-("-"), TAX%("%")

K11: Select with Fixed point or floating mode (ADD, 6, 5, 4, 3, 2, 1, 0, F).

Preliminary

PRE-RATE VALUE SELECTION

Pre-rate values are exchange rates of the current Euro membership states (the way of selecting one from pre-rate 11 values).

When pressing “→” key for the first time, the rate No.1 is always chosen. As “→”key is pressed repeatedly after the first press, the rate selected is changed in the sequence of 2, 3, 4, ... 11, 1, 2, ...

The pre-rate values are the exchange rate between the 11 Euro membership states and Euro as shown in the list below.

No.	Pre-rate value	Corresponding currency unit
1	13.7603	Austrian schilling (ATS)
2	40.3399	Belgian franc (BEF)
3	1.95583	Deutsche mark (DEM)
4	166.386	Spanish peseta (ESP)
5	5.94573	Finnish markka (FIM)
6	6.55957	French franc (FRF)
7	0.787564	Irish pound (IEP)
8	1936.27	Italian lira (ITL)
9	40.3399	Luxembourg franc (LUF)
10	2.20371	Dutch guilder (NLG)
11	200.482	Portuguese escudo (PTE)



Preliminary

OPERATION EXAMPLES

Type of calculation	Operation	Key-in	Display
Addition and Subtraction calculation	TAB SW: 2, GT SW: Off, Round SW: 5/4		
	100 + 200 = 300	C 100 + 200 =	0. 100. 300.00
	3 - 5 = -2	C 3 - 5 =	0. 3. -2.00
	10 + 20 - 50 = -20	C 10 + 20 - 50 =	0. 10. 30. -20.00
Multiplication and Division calculation	TAB SW: 2, GT SW: Off, Round SW: 5/4		
	(-2) x 3 = -6.	1. C	0.
		2. 2 +/- x 3 =	-2. -6.00
	(-365) ÷ 7 = -52.14	1. C	0.
		2. 365 +/- ÷ 7 =	-365. -52.14
	300 x 2,145 = 643,500 300 x 4,950.6 = 1,485,180	-	-
		2 x 3 =	-2. -6.00
	31,750 ÷ 500 = 63.50 54,236 ÷ 500 = 108.47	1. C	0.
2. 365 ÷ 7 =		-365. -52.14	
Square and Cube calculation	TAB SW: 2, GT SW: Off, Round SW: 5/4		
	3 ² = 9	C 3 x =	0. 3. 9.00
	5 ³ = 125	C 5 x = =	0. 5. 25.00 125.00
Reciprocal calculation	TAB SW: 2, GT SW: Off, Round SW: 5/4		
	1 ÷ 4 = 0.25	1. C 1 ÷ 4 = 2. 4 ÷ =	0. 1. 0.25 4. 0.25



Preliminary

Percentage calculation	TAB SW: 2, GT SW: Off, Round SW: 5/4		
	2,350 x 17 % = 399.50	C 2350 x 17 %	0. 2,350. 399.50
	456 ÷ 789 % = 57.79	C 456 ÷ 789 %	0. 456. 57.79
	2,000 + (2,000 x 12 %) = 2,240	C 2000 x 12 % + =	0. 2,000. 240.00 240.00 2,240.00
	2,000 – (2,000 x 12 %) = 1,760	C 2000 x 12 % – =	0. 2,000. 240.00 240.00 1,760.00
“→” key	TAB SW: 2, GT SW: Off, Round SW: 5/4		
		C 122.5 → 3 → → → 345 + 0.678 =	0. 122.5 122. 122.3 122. 12. 12,345. 12,345.68
		→ x 10 % →	12,345.6 12,345.6 1,234.56 1,234.5
	TAB SW: 2, GT SW: Off, Round SW: 5/4		
		C 1 + 2 + 3 + 4 + ÷ 3 RV =	0. 1. 3. 6. 10. 10. 3. 10. 0.30
	TAB SW: 2, GT SW: Off, Round SW: 5/4		
		C 25 ^{1/2} = 5 √ =	0. 25. 5. 5.00
		C 10 x (9 ^{1/2}) ÷ 2 = 15 10 x 9 √ ÷ 2 =	0. 10. 3. 30. 15.00
Clear Entry (CE)	TAB SW: 2, GT SW: Off, Round SW: 5/4		
		C 123 x 756 CE 456 =	0. 123. 756. 0. 56,088.00



Preliminary

	$-200,000,000,000$ $= -200,000,000,000$ $960 + 4$ $= 964$ GT $= -199,999,998,460$	GT SW: On $2000000000000000 +/-$ $=$ $960 +$ $4 =$ GT GT	G $-20,000,000,000,000.$ G $-19,999,999,999,800.00$ G $960.$ G 964.000 G $-19,999,999,998,760.$ GT $-19,999,999,998,760.$
Store GT memory calculation	TAB SW: 3, GT SW: Off, Round SW: CUT		
	$1 \div 3$ GT+ $100 \div 6$ GT+ $1,000 \div 3$ GT- GT =	Round SW: CUT $1 \div$ 3 GT+ $100 \div$ 6 GT+ Round SW: UP $1000 \div$ 3 GT- GT GT GT	C $0.$ G 0.333 G $100.$ G 16.666 G $1,000.$ G 333.334 G -316.335 G -316.335 G -316.335
Mark up calculation	TAB SW: 2, GT SW: Off, Round SW: 5/4		
	Cost: 9,000 Profit rate: 20% Selling price $= 9,000 \div (1 - 20 \div 100)$ $= 11,250$	C $0.$ $9000 \times$ 20 MU MU $11,250.00$ $2,250.00$	
Mark down calculation	Selling price: 2,400 Profit rate: 20% Cost $= 2,400 \div (1 + 20 \div 100)$ $= 2,000$	C $0.$ $2400 \div$ 20 MU MU $2,000.00$ 400.00	
Delta percent calculation	TAB SW: 2, GT SW: Off, Round SW: 5/4		
	Original value: 15,000 New value: 18,000 Increment rate $= (18,000 - 15,000) \div$ $15,000 \times 100$ $= 20 \%$	C $0.$ 1. $18000 \div$ $15000 \Delta\%$ 20.00 2. $18000 -$ 15000 MU 20.00	
Constant calculation 1. Multiplication	TAB SW: 1, GT SW: Off, Round SW: 5/4		
	$2 \times 3 = 6$ $2 \times 10 = 20$ $2 \times 20 = 40$	TAB SW: 6 $2 \times$ $3 =$ $10 =$ $20 =$	C $0.$ $2.$ 6.000000 20.000000 40.000000



Preliminary

2. Division	$36 \div 3 = 12$ $24 \div 3 = 8$ $6 \div 3 = 2$	TAB SW: 5 $36 \div$ $3 =$ $24 =$ $6 =$	$36.$ 12.00000 8.00000 2.00000
3. Percent	$1,500 \times 15 \% = 225$ $1,500 \times 30 \% = 450$ $1,500 \times 3 \% = 45$ $200 \div 3 \% = 6,666.7$ $1,500 \div 3 \% = 50,000.0$ $300 \div 3 \% = 10,000.0$	TAB SW: 4 $1500 \times$ 15% 30% 3% TAB SW: 1 $200 \div$ 3% 1500% 300%	$1,500.$ 225.0000 450.0000 45.0000 $200.$ $6,666.7$ $50,000.0$ $10,000.0$
4. Mark up	Cost: 9,000 Profit rate: 20% Selling price $= 9,000 \div (1 - 20 \%)$ $= 11,250$ Profit rate: 40% Selling price $= 9,000 \div (1 - 40 \%)$ $= 15,000$	TAB SW: F $9000 \times$ 20 MU MU 40 MU MU	$9,000.$ $11,250.$ $2,250.$ $15,000.$ $6,000.$
5. Mark down	Selling price: 2,400 Profit rate: 20% Cost $= 2,400 \div (1 + 20 \%)$ $= 2,000$ Profit rate: 40% Cost $= 2,400 \div (1 + 40 \%)$ $= 1,714.29$	TAB SW: 2 $2400 \div$ 20 MU MU 40 MU MU	$2,400.$ $2,000.00$ 400.00 $1,714.29$ 685.71
Overflow	TAB SW: 2, GT SW: Off, Round SW: CUT		
1. Addition and Subtraction calculation	$- 60,000,000,000,000 -$ $60,000,000,000,000$ $=$ $- 120,000,000,000,000 \text{ E}$ $40,000,000,000,000 +$ $40,000,000,000,000 -$ $40,000,000,000,000 -$ $40,000,000,000,000 -$ $40,000,000,000,000 +$ $40,000,000,000,000 +$ $40,000,000,000,000 +$ $40,000,000,000,000$ $= 120,000,000,000,000 \text{ E}$	$\text{C}6000000000000000 +/-$ $-$ $6000000000000000 =$ C/CE C/CE $400000000000000 +$ $400000000000000 -$ $400000000000000 -$ $400000000000000 +$ $400000000000000 +$ $400000000000000 +$ $400000000000000 =$ CE	$-60,000,000,000,000.$ $-60,000,000,000,000.$ -1.20000000000000 -1.20000000000000 $0.$ $40,000,000,000,000.$ $80,000,000,000,000.$ $40,000,000,000,000.$ $0.$ $40,000,000,000,000.$ $80,000,000,000,000.$ 1.20000000000000 1.20000000000000 E $0.$ $10,000,000,000,000.$ 20.00000000000000 $0.$ $12,300,000,000,000.$ 123.00000000000000 $0.$
2. Multiplication and Division calculation	$10,000,000,000,000 \times$ 200 $= 2,000,000,000,000,000 \text{ E}$ $12,300,000,000,000 \div$ 0.001 $=$ $12,300,000,000,000,000 \text{ E}$	C $1000000000000000 \times$ $200 =$ C $1230000000000000 \div$ $0.001 =$ C	$0.$ E $0.$ E $0.$



Preliminary

3. Division by zero	1 ÷ 0 = 0. E		C 1 ÷ 0 =		0. 1. 0.
4. Store (M, MII & GT) memory calculation	80,000,000,000,000 M+ M+ E M = 80,000,000,000,000	80000000000000 M+	C M+ M C RM CM	M ME M M	0. 80,000,000,000,000. 1.60000000000000 0. 80,000,000,000,000. 80,000,000,000,000.
5. GT memory calculation	90,000,000,000,000 = 90,000,000,000,000 = E	GT SW: On 9000000000000000 = 9000000000000000 =	C GT GT	G GE G G	0. 9,000,000,000,000,000. 1.80000000000000 0. 90,000,000,000,000. 90,000,000,000,000.
TAX calculation TAB SW: 2, GT SW: Off, Round SW: UP					
1. TAX rate setting	TAX rate: 5% 1. Key mode.		C Rate 5 TAX+	Rate Rate TAX%	0. 0. 5.
			C 5 Rate TAX+	Rate Rate TAX%	0. 5. 5.
	2. Switch mode.		C 5 TAX+	Rate TAX%	0. 5.
2. TAX rate recall	1. Key mode.		C Rate TAX-	Rate TAX%	0. 0. 5.
	2. Switch mode.		C TAX-	TAX%	0. 5.
3. TAX+ calculation	TAX rate: 5%		C 800 TAX+ TAX+ TAX+	 TAX+ TAX TAX+	0. 800. 840.00 40.00 840.00
4. TAX- calculation	TAX rate: 5%		C 840 TAX- TAX- TAX-	 TAX- TAX TAX-	0. 840. 800.00 40.00 800.00
5. Calculation including TAX+ values	TAX rate: 20%		C 100 + 1000 TAX+ + 2000 TAX+ TAX+ =	 TAX+ TAX+ TAX	0. 100. 1,200.00 1,300. 2,400.00 400.00 1,700.00
6. Calculation including TAX- values	TAX rate: 20%		C 100 + 2400 TAX- + 3600 TAX- TAX- =	 TAX- TAX- TAX	0. 100. 2,000.00 2,100. 3,000.00 600.00 2,700.00



Preliminary

Exchange rate setting to Euro and currency (C1~C5)	Option: PreRate			
	1. Key mode	C	Rate	0.
		5	Rate	5.
		Euro	Rate Euro	5.
		C	Rate	0.
		Rate	Rate	0.
		→ → →	Rate	1.95583
		Euro	Rate Euro	1.95583
		C	Rate	0.
		Rate	Rate	0.
		→	Rate	13.7603
		2nd	Rate 2nd	13.7603
		C1	Rate C1	13.7603
		C	Rate	0.
		2nd	Rate 2nd	0.
		Rate	Rate 2nd	0.
		10	Rate 2nd	10.
		C2	Rate C2	10.
		C	Rate	0.
		20	Rate	20.
		Rate	Rate	20.
		2nd	Rate 2nd	20.
		C3	Rate C3	20.
	2. Switch mode: Rate	C	Rate	0.
		→	Rate	13.7603
		Euro	Rate Euro	13.7603
		C	Rate	0.
		20	Rate	20.
		→ → →	Rate	1.95583
		2nd	Rate 2nd	1.95583
		C1	Rate C1	1.95583
		C	Rate	0.
		2nd	Rate 2nd	0.
		30	Rate 2nd	30.
		C4	Rate C4	30.
	3. Switch mode: 2nd	C	Rate	0.
		Rate	Rate	0.
		2	Rate	2.
		Euro	Rate Euro	2.
		C	Rate	0.
		Rate	Rate	0.
		→ → →	Rate	1.95583
		5	Rate	5.
		C1	Rate C1	5.
		C	Rate	0.
		Rate	Rate	0.
		40	Rate	40.
		C5	Rate C5	40.
Exchange rate recall	1. Key mode	C	Rate	0.
		Rate	Rate	0.
		Local	Rate Euro	2.
		C	Rate	0.
		Rate	Rate	0.
		C1	Rate C1	5.
		C	Rate	0.
		100	Rate	100.
		Rate	Rate	100.
		C2	Rate C2	10.



Preliminary

	2. Switch mode: Rate	C 123 Local Rate Euro	0. 123. 2. 0.
		C C3 Rate C3	0. 20.
		C → Rate	0. 13.7603
		C4 Rate C4	30.
		C C5 Rate C5	0. 40.
Euro → Local conversion	TAB SW: 2, GT SW: Off, Round SW: CUT		
	Euro Rate: 1.23456	C 1000 Local Local Local Local Euro Euro	0. 1,000. 1,234.56 1,234.56 1,000.
Local → Euro conversion	TAB SW: 1, GT SW: Off, Round SW: CUT		
	Euro Rate: 1.23456	C 1000 Euro Euro Euro Euro Local Local	0. 1,000. 810.0 810.0 1,000
Currency exchange	TAB SW: 2, GT SW: Off, Round SW: CUT		
	1. Key mode C1 Rate: 5 C2 Rate: 10 C3 Rate: 20 C4 Rate: 30 C5 Rate: 40 Euro Rate: 2	C 1000 2nd C1 2nd C2 2nd C2 2nd C3 2nd C3 2nd C4 2nd C4 2nd C5 Euro Euro Local Local	0. 1,000. 1,000. 200.00 200.00 100.00 100.00 50.00 50.00 33.33 33.33 25.00 500.00 1,000
	TAB SW: 2, GT SW: Off, Round SW: UP		
	2. Switch mode: 2nd	C 2000 C1 C1 C2 C2 C3 C3 C4 C4 C5 C5 Euro Euro Local Local	0. 2,000. 400.00 200.00 100.00 66.67 50.00 1,000.00 2,000



Preliminary

Calculation including values conversion	TAB SW: 2, GT SW: Off, Round SW: 5/4		
	Switch SW: 2nd	C	0.
	C1 Rate: 5	250.11 +	250.11
	C2 Rate: 10	123 Euro	Euro 62.89
	C3 Rate: 20	+	313.
	C4 Rate: 30	100 +	413.
	C5 Rate: 40	350 Euro	Euro 178.95
	Euro Rate: 1.95583	+	591.95
		1234 C1	C1 246.80
		+	838.75
		1234 C2	C2 123.40
		+	962.15
		1234 C3	C3 61.70
		+	1023.85
		1234 C4	C4 41.13
		+	1064.98
		1234 C5	C5 30.85
		=	1095.83



Preliminary

ABOLUTE MAXIMUM RATINGS

Items	Sym.	Min.	Max.	Unit
Supply Voltage	VDD-VSS	-0.3	2.0	V
Input Voltage	V _{IN}	-0.3	VDD+0.3	V
Operating Temperature	T _{OP}	0	50	°C
Storage Temperature	T _{STG}	-55	+125	°C

DC ELECTRICAL CHARACTERISTICS

(VDD=1.5V±0.3V, VSS=0V, TA=25 °C, VEE=3.0±0.4V)

Parameter	Pin Name	Sym.	Min.	Typ.	Max.	Unit	Condition
Operating Voltage	-	V _{DD}	1.2	1.5	1.8	V	
“1” Input Voltage	K3~K10	V _{IH} (1)	V _{DD} -0.4	-	V _{DD}	V	
“1” Input Voltage	K11~K14	V _{IH} (2)	V _{EE} -0.4	-	V _{EE}	V	
“0” Input Voltage	K3~K14	V _{IL} (1)	0	-	0.4	V	
“1” Input Voltage	RESET	V _{IH} (3)	0.6 V _{DD}	-	V _{DD}	V	VDD=1.5V
“0” Input Voltage	RESET	V _{IL} (2)	0	-	0.4 V _{DD}	V	VDD=1.5V
“1” Output Voltage	SEGMENT COM1~3	V _{OH} (1)	V _{EE} -0.2	-	V _{EE}	V	
“0” Output Voltage	SEGMENT COM1~3	V _{OL} (1)	0	-	0.2	V	
“M” Output Voltage	COM1~3	V _{OM}	V _{DD} -0.2	-	V _{DD} +0.2	V	
“1” Output Voltage	K0~K7	V _{OH} (2)	V _{DD} -0.2	-	V _{DD}	V	
“0” Output Voltage	K0~K7	V _{OL} (2)	0	-	0.2	V	
“1” Output Resistance	SEGMENT COM1~3	R _{OH}	-	-	70	KΩ	V _{OUT} = V _{EE} -0.5V
“0” Output Resistance	SEGMENT COM1~3	R _{OL}	-	-	70	KΩ	V _{OUT} = 0.5V



Preliminary

Parameter	Name	Sym.	Min.	Typ.	Max.	Unit	Condition
Key Pull Down Resistance	K0~K10	R _{KEYL} (1)	240	-	650	KΩ	V _{OUT} = V _{DD}
Key Pull Up Resistance	K0~K7	R _{KEYH} (1)	-	-	10	KΩ	V _{OUT} = 0.5V
	RESET	R _{KEYH} (2)	50	-	370	KΩ	V _{OUT} = 0.5V
Switch Pull Down Resistance	K11~K14	R _{SW} (1)	240	400	800	KΩ	V _{OUT} = V _{EE}
Oscillating Frequency	(Wait) TS1	F _{0WAIT}	19.6	28	36.4	KHz	
	(Operate) TS1	F _{0OP}	100	195	290	KHz	
Frame Frequency	SEGMENT COM1~3	f _F	130	146	162	Hz	
Supply Current	1 (WAIT)	I _{DDWAIT}	-	4.0	5.5	μA	V _{DD} = 1.5V
	2 (OPERATE)	I _{DDOP}	-	22	35	μA	V _{DD} = 1.5V
	3 (OFF)	I _{DDOFF}	-	-	1.0	μA	V _{DD} = 1.5V

Preliminary

APPLICATION BLOCK DIAGRAM

- Battery Type

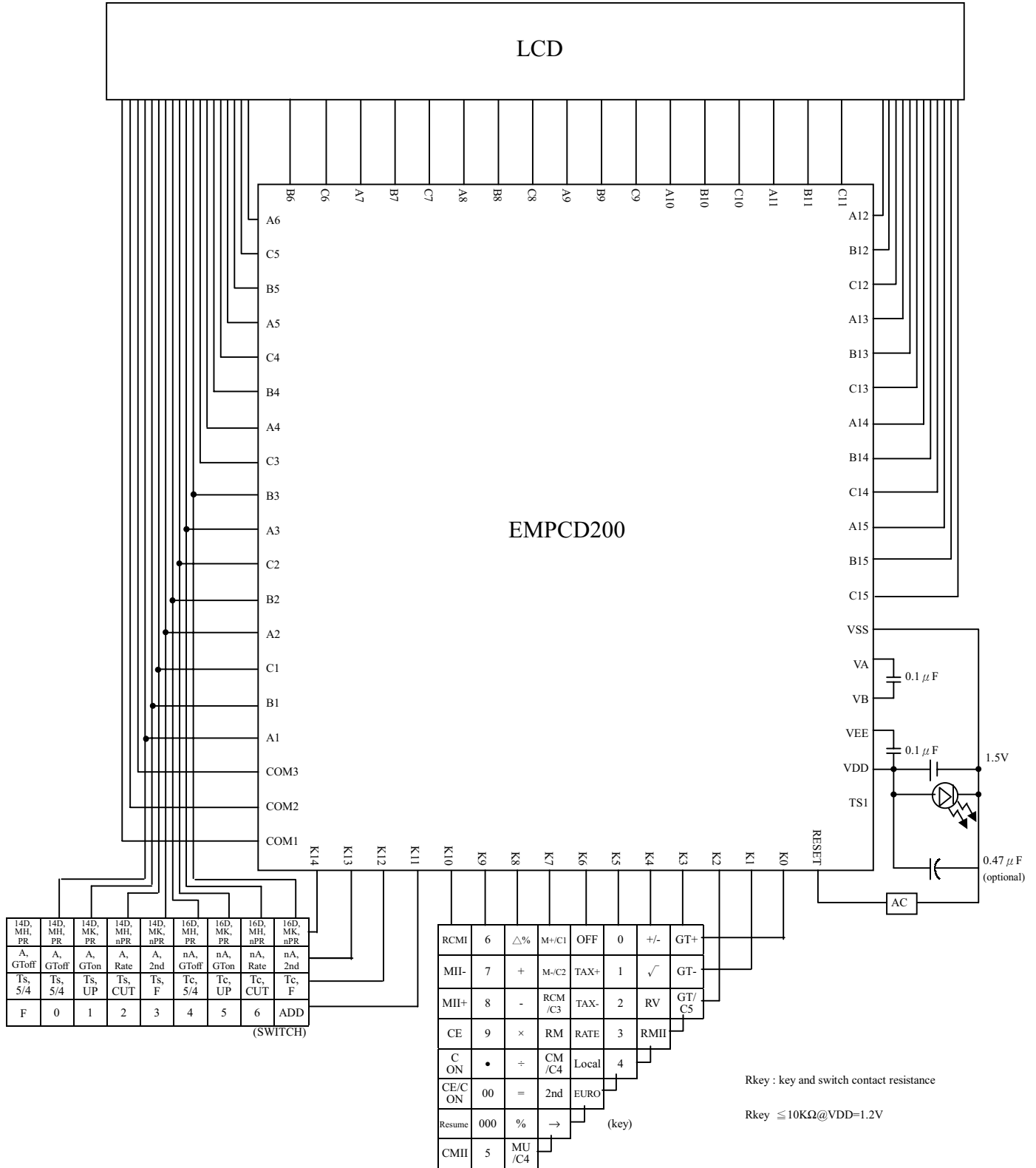



Preliminary

• Solar Type

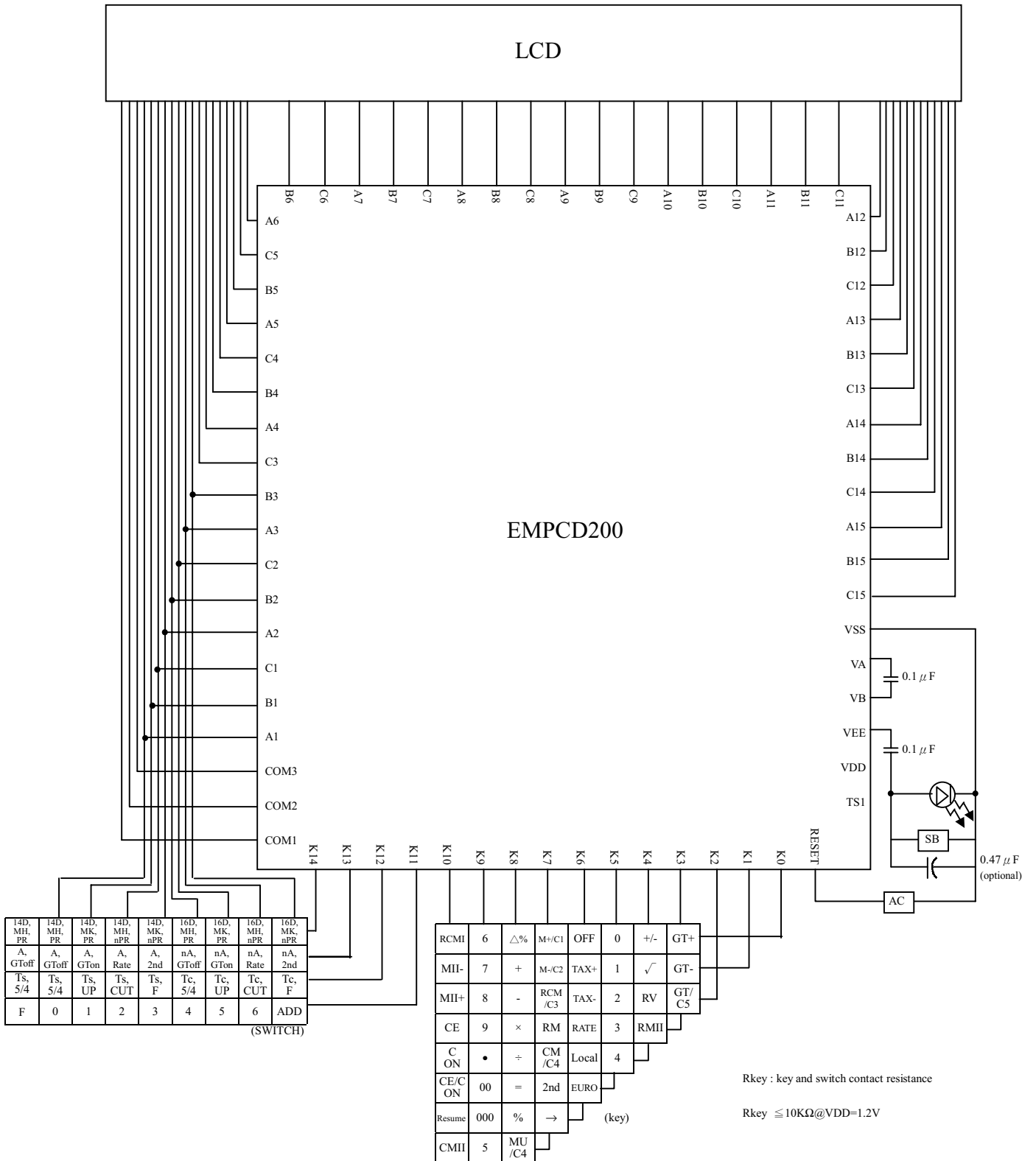

Preliminary

• Dual Type

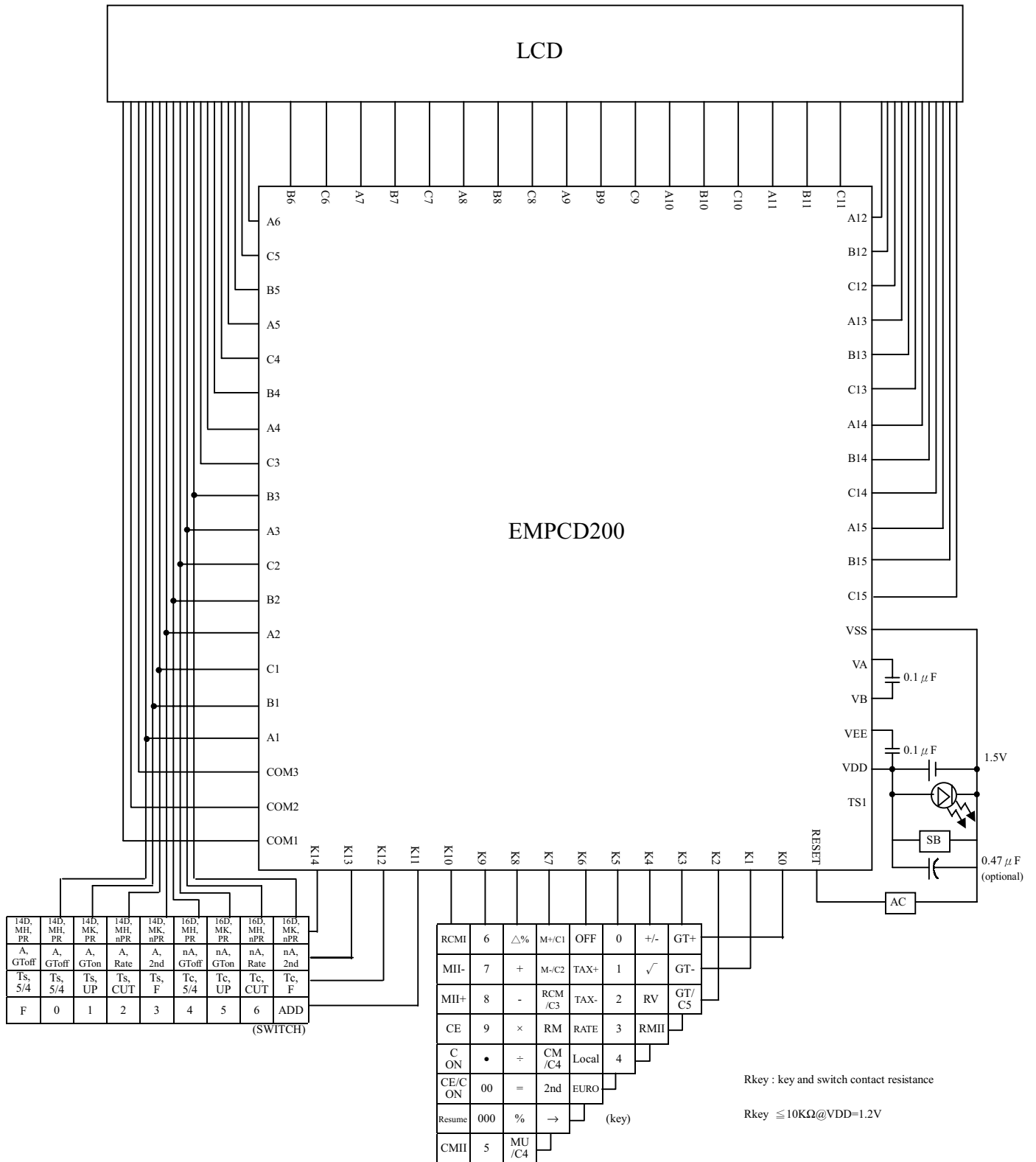

Rkey : key and switch contact resistance
Rkey ≤ 10KΩ@VDD=1.2V



Preliminary

PAD DIAGRAM

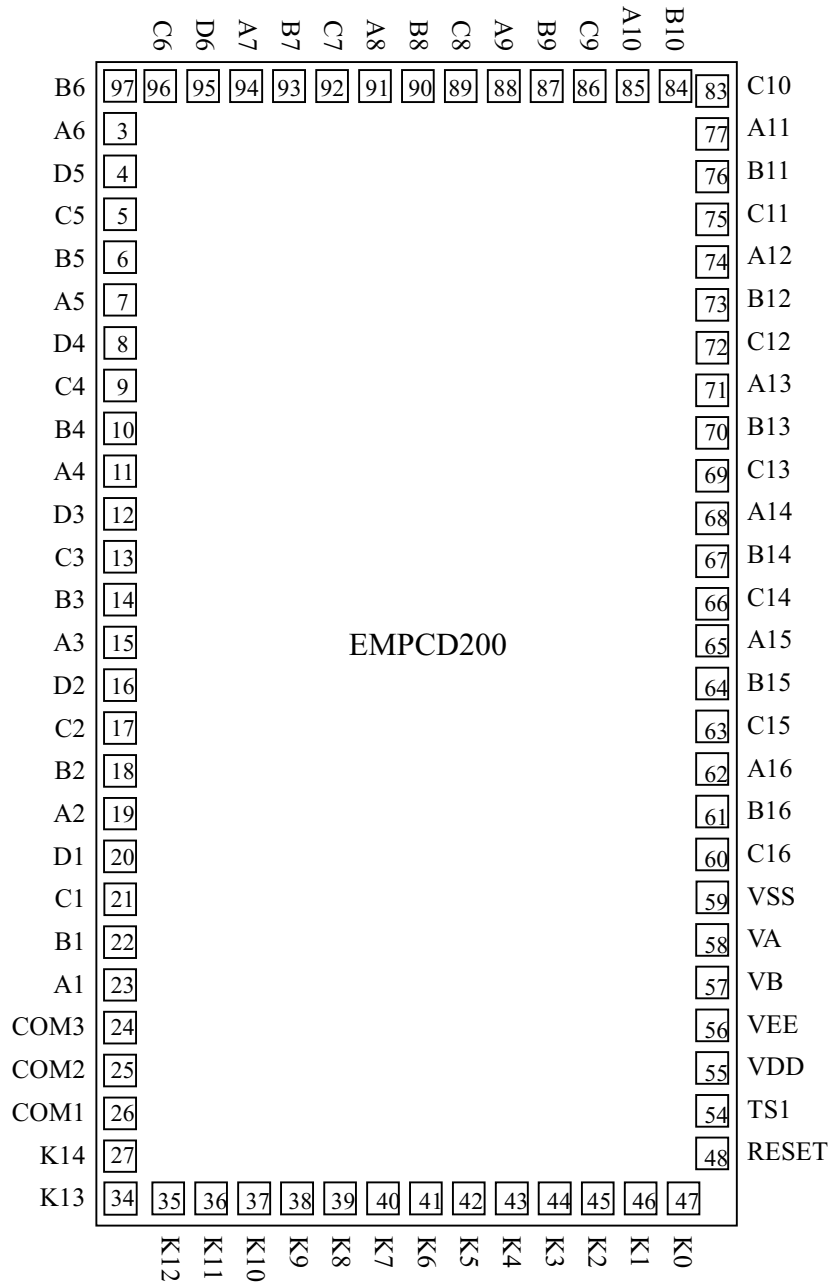



Preliminary

Pad No.	Symbol	X	Y
1	NC		
2	NC		
3	A6	-770.0	1310.0
4	D5	-770.0	1190.0
5	C5	-770.0	1075.0
6	B5	-770.0	965.0
7	A5	-770.0	855.0
8	D4	-770.0	745.0
9	C4	-770.0	635.0
10	B4	-770.0	527.5
11	A4	-770.0	420.0
12	D3	-770.0	315.0
13	C3	-770.0	210.0
14	B3	-770.0	105.0
15	A3	-770.0	0.0
16	D2	-770.0	-105.0
17	C2	-770.0	-210.0
18	B2	-770.0	-315.0
19	A2	-770.0	-420.0
20	D1	-770.0	-527.5
21	C1	-770.0	-635.0
22	B1	-770.0	-745.0
23	A1	-770.0	-855.0
24	COM3	-770.0	-965.0
25	COM2	-770.0	-1075.0
26	COM1	-770.0	-1190.0
27	K14	-770.0	-1310.0
28	NC		
29	NC		
30	NC		
31	NC		
32	NC		
33	NC		
34	K13	-770.0	-1435.0
35	K12	-645.0	-1435.0
36	K11	-535.0	-1435.0
37	K10	-425.0	-1435.0
38	K9	-317.5	-1435.0
39	K8	-210.0	-1435.0
40	K7	-105.0	-1435.0



Preliminary

Pad No.	Symbol	X	Y
41	K6	0.0	-1435.0
42	K5	105.0	-1435.0
43	K4	210.0	-1435.0
44	K3	317.5	-1435.0
45	K2	425.0	-1435.0
46	K1	535.0	-1435.0
47	K0	645.0	-1435.0
48	RESET	770.0	-1435.0
49	NC		
50	NC		
51	NC		
52	NC		
53	NC		
54	TS1	770.0	-1310.0
55	VDD	770.0	-1190.0
56	VEE	770.0	-1070.0
57	VB	770.0	-950.0
58	VA	770.0	-835.0
59	VSS	770.0	-720.0
60	C16	770.0	-605.0
61	B16	770.0	-495.0
62	A16	770.0	-385.0
63	C15	770.0	-275.0
64	B15	770.0	-165.0
65	A15	770.0	-55.0
66	C14	770.0	55.0
67	B14	770.0	165.0
68	A14	770.0	275.0
69	C13	770.0	385.0
70	B13	770.0	495.0
71	A13	770.0	605.0
72	C12	770.0	720.0
73	B12	770.0	835.0
74	A12	770.0	950.0
75	C11	770.0	1070.0
76	B11	770.0	1190.0
77	A11	770.0	1310.0
78	NC		
79	NC		
80	NC		



Preliminary

Pad No.	Symbol	X	Y
81	NC		
82	NC		
83	C10	770.0	1435.0
84	B10	645.0	1435.0
85	A10	535.0	1435.0
86	C9	425.0	1435.0
87	B9	317.5	1435.0
88	A9	210.0	1435.0
89	C8	105.0	1435.0
90	B8	0.0	1435.0
91	A8	-105.0	1435.0
92	C7	-210.0	1435.0
93	B7	-317.5	1435.0
94	A7	-425.0	1435.0
95	D6	-535.0	1435.0
96	C6	-645.0	1435.0
97	B6	-770.0	1435.0
98	NC		
99	NC		
100	NC		

Chip size:1800 x 3130 um

Note : For PCB layout, IC substrate must be connected to VSS.