

PTF 10021

30 Watts, 1.4–1.6 GHz

GOLDMOS™ Field Effect Transistor

Description

The PTF 10021 is an internally matched common source N-channel enhancement-mode lateral MOSFET intended for linear driver and final applications in the 1.4 to 1.6 GHz range such as DAB/DAR. It is rated at 30 watts power output. Nitride surface passivation and full gold metallization ensure excellent device lifetime and reliability.

- **INTERNALLY MATCHED**
- **Performance at 1.5 GHz, 28 Volts**
 - Output Power = 30 Watts Min
 - Power Gain = 13 dB Typ
 - Efficiency = 48% Typ
- **Full Gold Metallization**
- **Silicon Nitride Passivated**
- **Excellent Thermal Stability**
- **100% Lot Traceability**

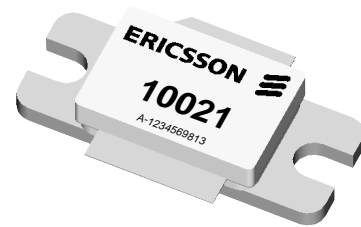
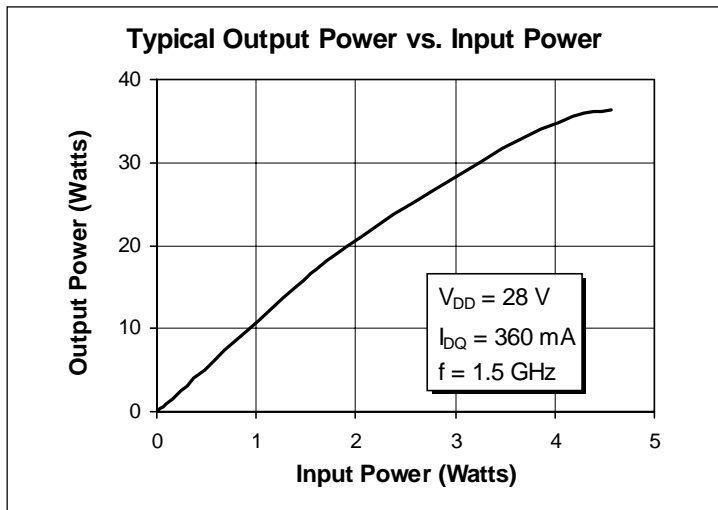

Package 20237

RF Specifications (100% Tested)

Characteristic	Symbol	Min	Typ	Max	Units
Gain ($V_{DD} = 28\text{ V}$, $P_{OUT} = 10\text{ W}$, $I_{DQ} = 360\text{ mA}$, $f = 1.5\text{ GHz}$)	G_{ps}	11.0	13.0	—	dB
Power Output at 1 dB Compressed ($V_{DD} = 28\text{ V}$, $P_{OUT} = 30\text{ W}$, $I_{DQ} = 360\text{ mA}$, $f = 1.5\text{ GHz}$)	P-1dB	30	—	—	Watts
Drain Efficiency ($V_{DD} = 28\text{ V}$, $P_{OUT} = 30\text{ W}$, $I_{DQ} = 360\text{ mA}$, $f = 1.5\text{ GHz}$)	η	45	48	—	%
Load Mismatch Tolerance ($V_{DD} = 28\text{ V}$, $P_{OUT} = 30\text{ W(PEP)}$, $I_{DQ} = 360\text{ mA}$, $f = 1.5\text{ GHz}$ — all phase angles at frequency of test)	Ψ	—	—	10:1	—

All published data at $T_{CASE} = 25^\circ\text{C}$ unless otherwise indicated.

Electrical Characteristics (100% Tested)

Characteristic	Conditions	Symbol	Min	Typ	Max	Units
Drain-Source Breakdown Voltage	$V_{GS} = 0\text{ V}, I_D = 25\text{ mA}$	$V_{(BR)DSS}$	65	—	—	Volts
Drain-Source Leakage Current	$V_{DS} = 28\text{ V}, V_{GS} = 0\text{ V}$	I_{DSS}	—	—	1.0	mA
Gate Threshold Voltage	$V_{DS} = 10\text{ V}, I_D = 75\text{ mA}$	$V_{GS(th)}$	3.0	—	5.0	Volts
Forward Transconductance	$V_{DS} = 10\text{ V}, I_D = 3\text{ A}$	g_{fs}	—	2.2	—	Siemens

Maximum Ratings

Parameter	Symbol	Value	Unit
Drain-Source Voltage	V_{DSS}	65	Vdc
Gate-Source Voltage	V_{GS}	± 20	Vdc
Operating Junction Temperature	T_J	200	$^{\circ}\text{C}$
Total Device Dissipation at Above 25°C derate by	P_D	105 0.6	Watts $\text{W}/^{\circ}\text{C}$
Storage Temperature Range	T_{STG}	-40 to +150	$^{\circ}\text{C}$
Thermal Resistance ($T_{CASE} = 70^{\circ}\text{C}$)	$R_{\theta JC}$	1.65	$^{\circ}\text{C}/\text{W}$

Typical Performance

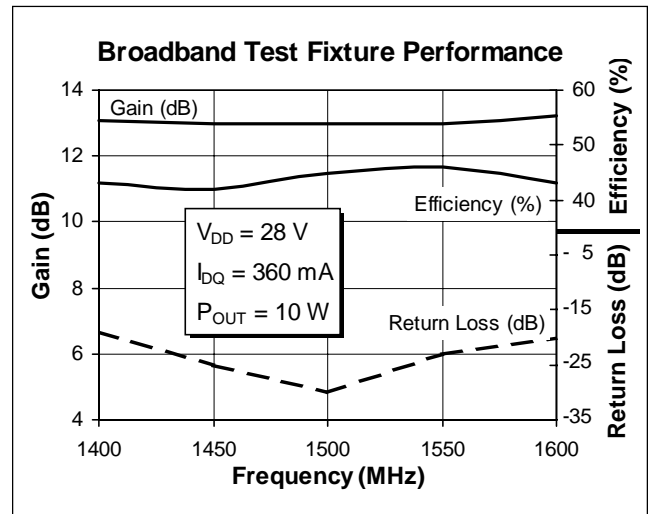
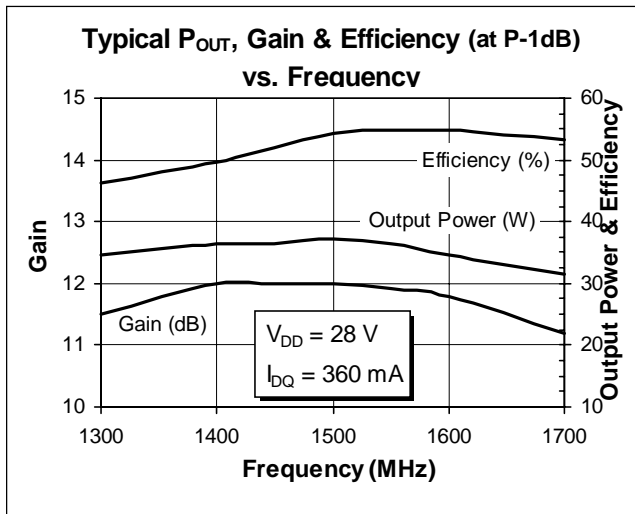

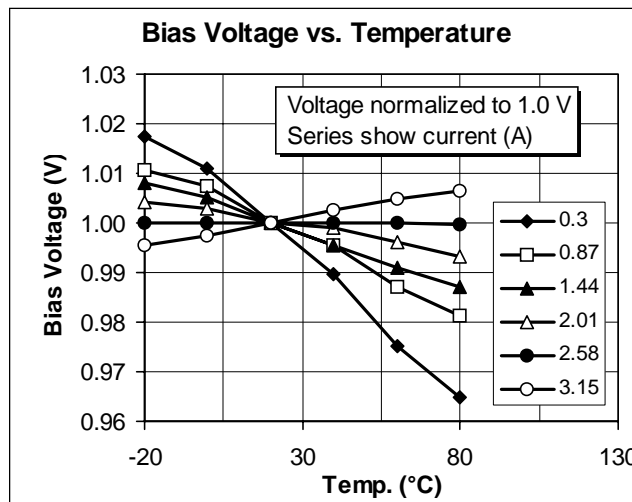
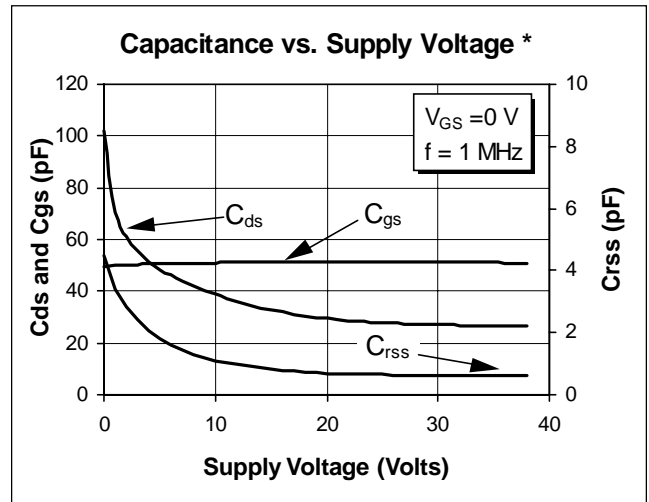
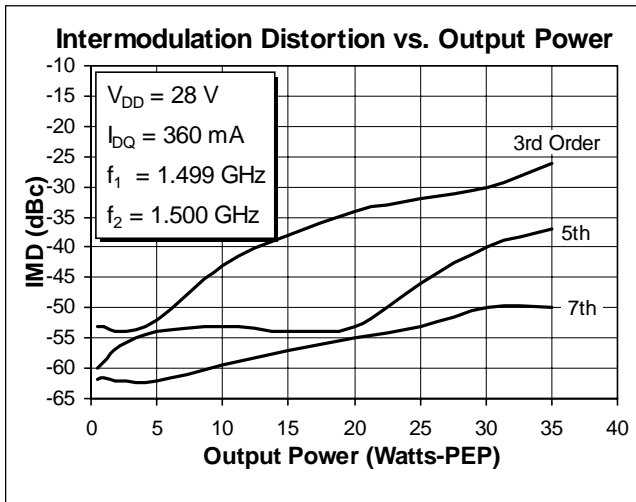
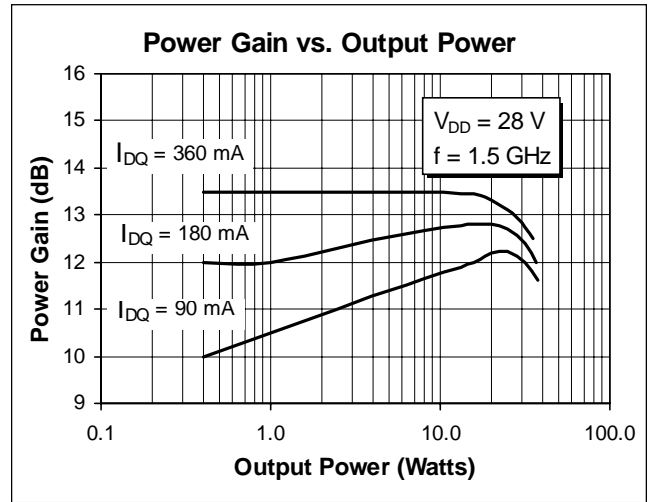
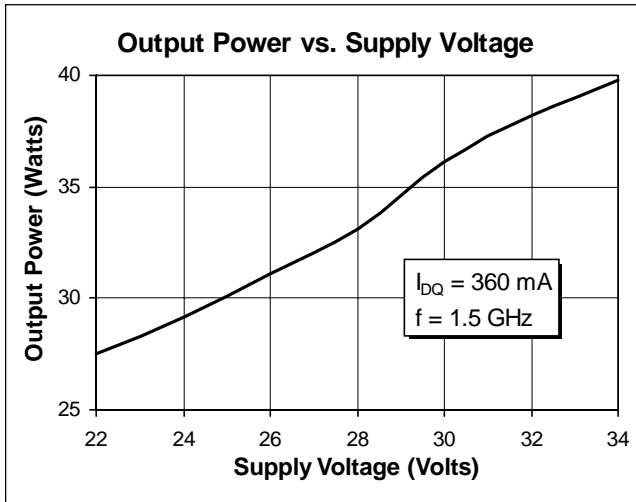

*This part is internally matched. Measurements of the finished product will not yield these figures.

Impedance Data

$V_{DD} = 28\text{ V}$, $P_{OUT} = 30\text{ W}$, $I_{DQ} = 360\text{ mA}$

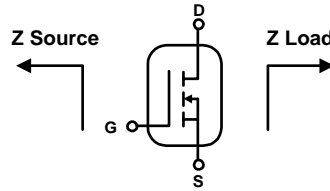

Frequency GHz	Z Source Ω		Z Load Ω	
	R	jX	R	jX
1.30	7.70	-8.77	3.08	-6.77
1.40	7.90	-9.30	3.32	-5.89
1.45	8.30	-10.52	3.45	-5.00
1.50	11.60	-10.60	3.50	-4.50
1.55	13.30	-7.30	3.80	-4.90
1.60	12.90	-5.70	3.70	-6.00
1.70	10.50	-2.07	3.30	-7.16

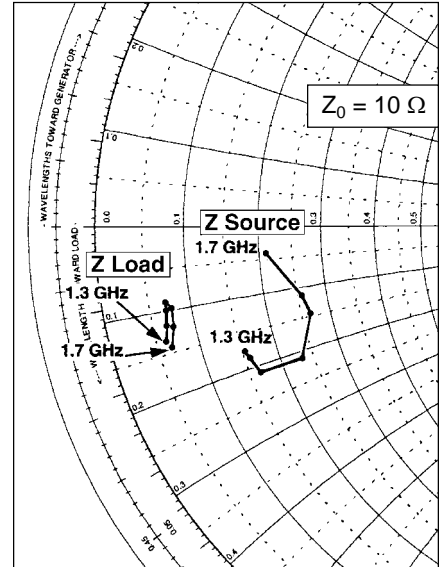

Typical Scattering Parameters

$(V_{DS} = 28\text{ V}$, $I_D = 900\text{ mA})$

f (MHz)	S11		S21		S12		S22	
	Mag	Ang	Mag	Ang	Mag	Ang	Mag	Ang
100	0.938	-150.8	4.529	35.0	0.0012	84.1	0.813	-162.
200	0.949	-156.9	3.199	31.9	0.0021	92.3	0.839	-166.
300	0.988	-169.3	0.825	12.0	0.0046	95.2	0.893	-172.
400	0.993	-174.7	0.325	5.8	0.0068	92.8	0.929	-176.
500	0.993	-178.1	0.108	9.3	0.0093	90.5	0.943	-179.
600	0.991	179.0	0.047	127.9	0.0123	86.2	0.981	177.7
700	0.990	176.6	0.154	150.5	0.0150	81.9	1.000	172.2
800	0.993	174.3	0.262	149.2	0.0177	77.9	0.947	167.8
900	0.998	171.7	0.393	145.6	0.0212	74.6	0.915	165.2
1000	0.999	168.6	0.586	140.5	0.0257	69.1	0.883	162.8
1100	1.000	164.8	0.927	132.9	0.0312	61.2	0.874	159.9
1200	0.996	158.8	1.662	120.1	0.0383	51.9	0.846	152.3
1300	0.898	145.7	3.504	84.7	0.0521	27.0	0.632	135.8
1400	0.590	144.7	4.350	30.7	0.0454	-12.0	0.259	160.0
1500	0.443	171.8	4.857	-15.9	0.0316	-57.1	0.472	-156.
1600	0.655	-175.3	3.876	-68.4	0.0090	-146.3	0.817	-170.
1700	0.747	-176.7	2.729	-102.8	0.0119	113.0	0.853	179.6
1800	0.831	-178.1	1.930	-132.0	0.0190	88.8	0.855	174.9
1900	0.904	178.4	1.315	-155.7	0.0263	74.8	0.859	171.6
2000	0.944	174.2	0.897	-172.8	0.0303	60.6	0.861	168.7
2100	0.966	170.6	0.641	175.3	0.0299	49.6	0.860	166.2
2200	0.990	167.3	0.491	166.2	0.0283	50.1	0.877	163.7

Test Circuit

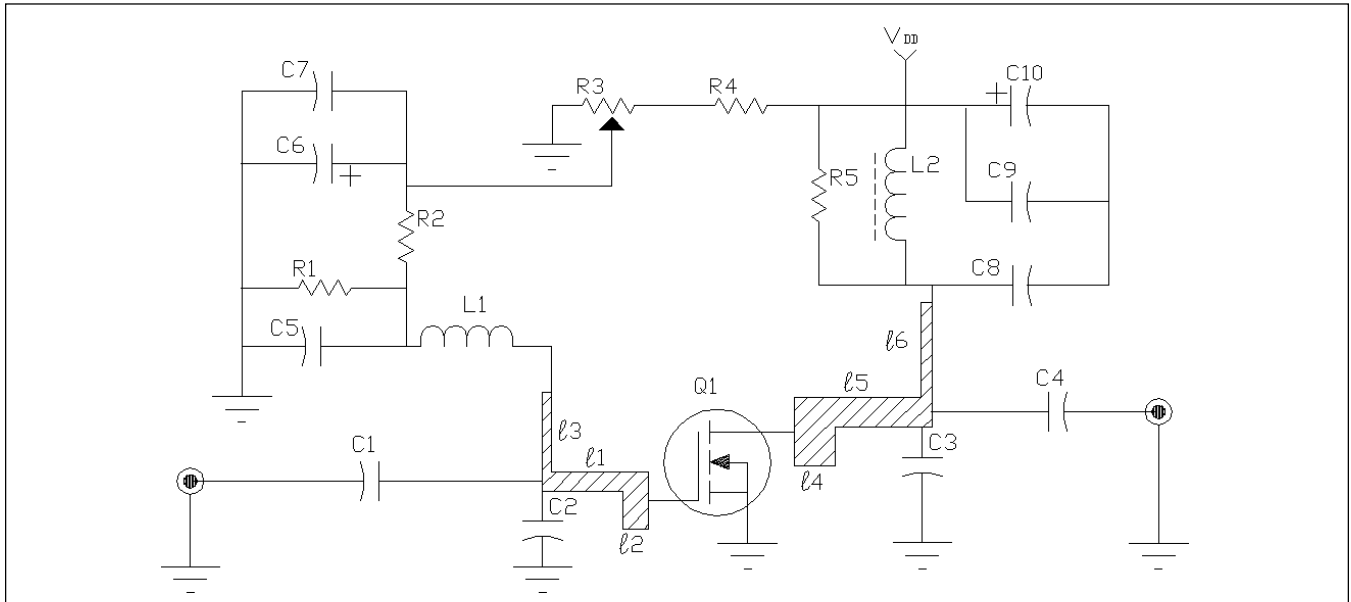

Schematic for $f = 1.5 \text{ GHz}$

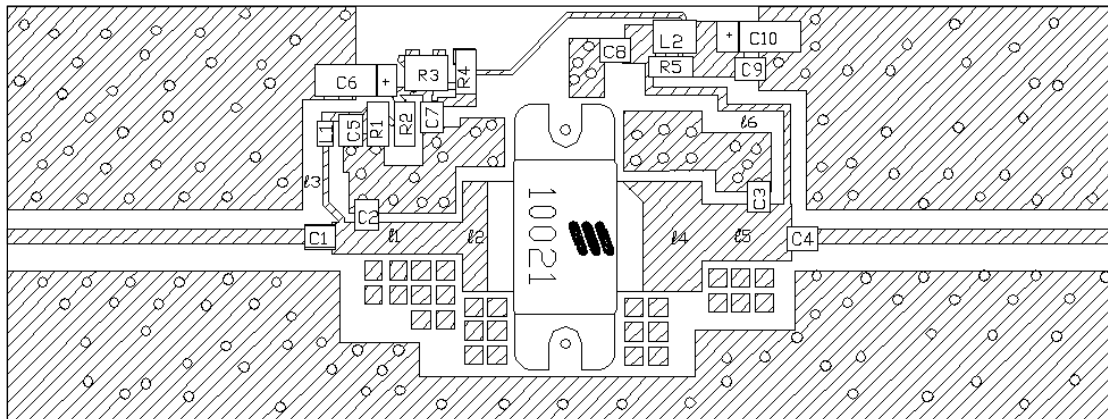

Placement Diagram (not to scale)

Q1	PTF 10021	Field Effect Transistor	C7	0.1 uF	Chip Cap
l1	0.11 λ 1.5 GHz	Microstrip 30.21 Ω	C8	33 pF	Chip Cap ATC 100 B
l2	0.0483 λ 1.5 GHz	Microstrip 11.69 Ω	C9	0.1 uF	Chip Cap
l3	0.07 λ 1.5 GHz	Microstrip 70 Ω	C10	10 uF	SMT Tantalum
l4	0.0853 λ 1.5 GHz	Microstrip 11.69 Ω	L1	2.7 nH	SMT Coil
l5	0.07 λ 1.5 GHz	Microstrip 21 Ω	L2		4mm Ferrite Bead
l6	0.25 λ 1.5 GHz	Microstrip 70 Ω	R1	220 Ω	K 1206 SMT
C1	33 pF	Chip Cap ATC 100 B	R2	220 Ω	K 1206 SMT
C2	1.3 pF	Chip Cap ATC 100 B	R3	2 K Ω	SMT Pot
C3	0.7 pF	Chip Cap ATC 100 B	R4	470 Ω	K 1206 SMT
C4, C5	33 pF	Chip Cap ATC 100 B	R5	2.2 Ω	K 1206 Smt
C6	10 uF	SMT Tantalum	Circuit Board		.028" Dielectric Thickness, $\epsilon_r = 4.0$, AlliedSignal, G200, 2 oz. copper

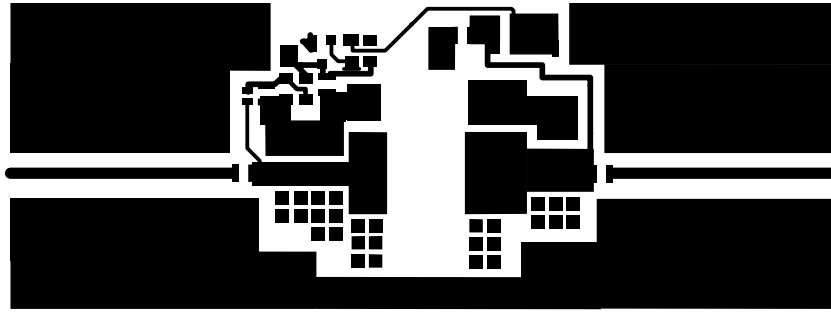

Artwork (1 inch )