

PTF 10031

50 Watts, 1.0 GHz

GOLDMOS™ Field Effect Transistor

Description

The PTF 10031 is a 50 Watt LDMOS FET intended for large signal amplifier applications to 1.0 GHz. It operates at 55% efficiency and 13.0 dB of gain. Nitride surface passivation and full gold metallization ensure excellent device lifetime and reliability.

- Performance at 960 MHz, 28 Volts
 - Output Power = 50 Watts
 - Power Gain = 13.0 dB Typ
 - Efficiency = 55% Typ
- Full Gold Metallization
- Silicon Nitride Passivated
- Excellent Thermal Stability
- Back Side Common Source
- Available in Package 20235 as PTF 10015
- 100% Lot Traceability

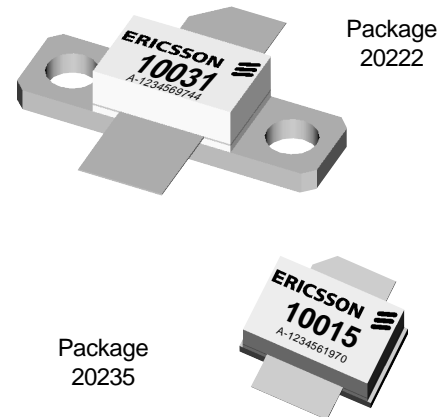
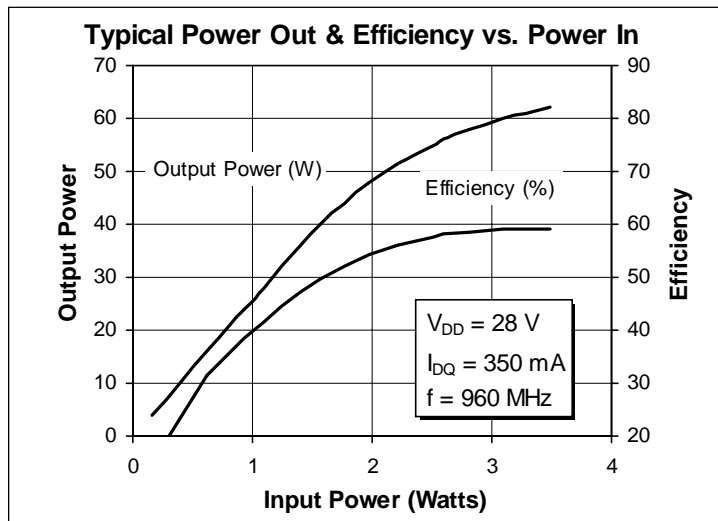

Maximum Ratings

Parameter	Symbol	Value	Unit
Drain-Source Voltage	V_{DSS}	65	Vdc
Gate-Source Voltage	V_{GS}	± 20	Vdc
Operating Junction Temperature	T_J	200	$^{\circ}\text{C}$
Total Device Dissipation $T_{CASE} = 25^{\circ}\text{C}$ Above 25°C derate by	P_D	175 1.0	Watts $\text{W}/^{\circ}\text{C}$
Storage Temperature Range	T_{STG}	-65 to 150	$^{\circ}\text{C}$
Thermal Resistance ($T_{CASE} = 70^{\circ}\text{C}$)	$R_{\theta JC}$	1.0	$^{\circ}\text{C}/\text{W}$

All published data at $T_{CASE} = 25^{\circ}\text{C}$ unless otherwise indicated.

Electrical Characteristics (100% Tested)

Characteristic	Conditions	Symbol	Min	Typ	Max	Units
Drain-Source Breakdown Voltage	$V_{GS} = 0\text{ V}, I_D = 25\text{ mA}$	$V_{(BR)DSS}$	65	—	—	Volts
Drain-Source Leakage Current	$V_{DS} = 28\text{ V}, V_{GS} = 0\text{ V}$	I_{DSS}	—	—	1.0	mA
Gate Threshold Voltage	$V_{DS} = 10\text{ V}, I_D = 75\text{ mA}$	$V_{GS(th)}$	3.0	—	5.0	Volts
Forward Transconductance	$V_{DS} = 10\text{ V}, I_D = 3\text{ A}$	g_{fs}	—	2.8	—	Siemens

RF Specifications (100% Tested)

Characteristic	Symbol	Min	Typ	Max	Units
Common Source Power Gain ($V_{DD} = 28\text{ V}, P_{OUT} = 50\text{ W}, I_{DQ} = 350\text{ mA}, f = 960\text{ MHz}$)	G_{ps}	12.0	13.0	—	dB
Power Output at 1 dB Compression ($V_{DD} = 28\text{ V}, I_{DQ} = 350\text{ mA}, f = 960\text{ MHz}$)	P-1dB	50	55	—	Watts
Drain Efficiency ($V_{DD} = 28\text{ V}, P_{OUT} = 50\text{ W}, I_{DQ} = 350\text{ mA}, f = 960\text{ MHz}$)	η	50	55	—	%
Load Mismatch Tolerance ($V_{DD} = 28\text{ V}, P_{OUT} = 50\text{ W}, I_{DQ} = 350\text{ mA}, f = 960\text{ MHz}$ — all phase angles at frequency of test)	Ψ	—	—	10:1	—

Typical Performance

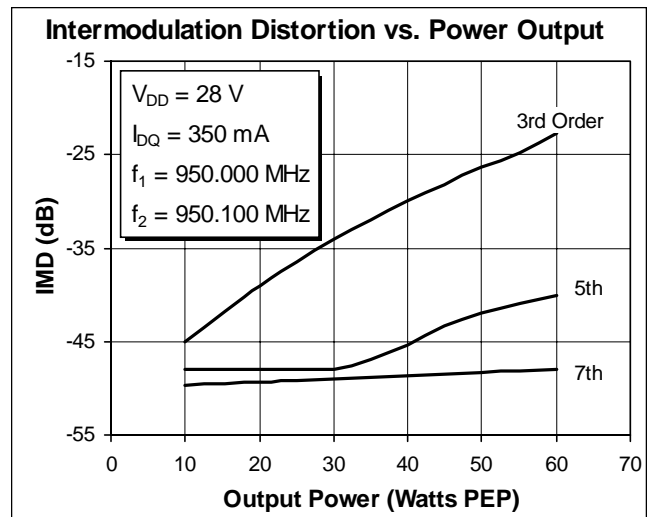
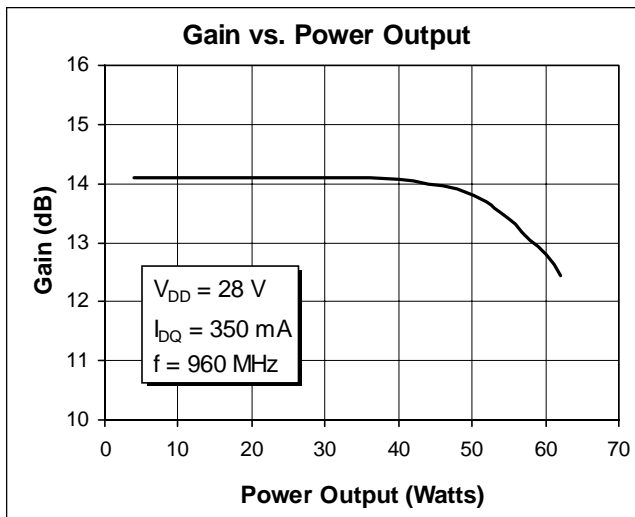

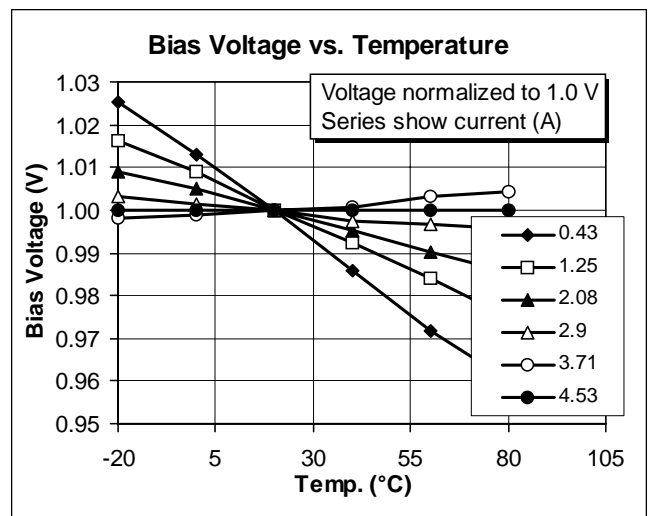
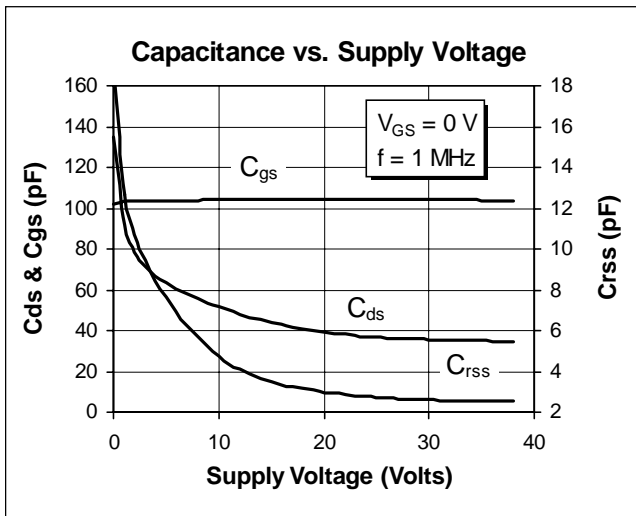
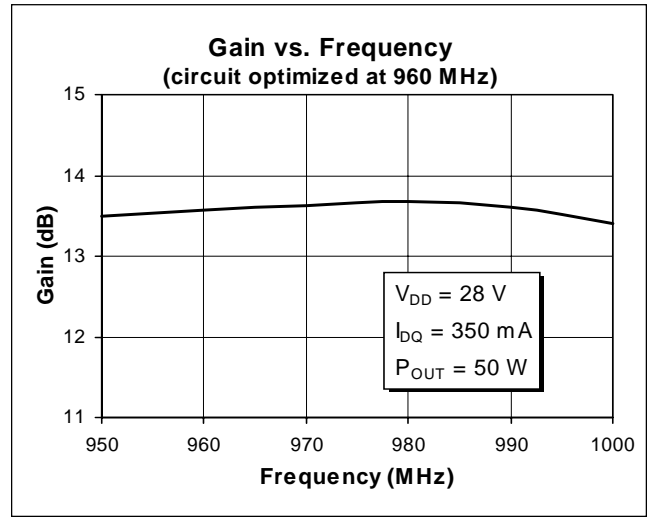
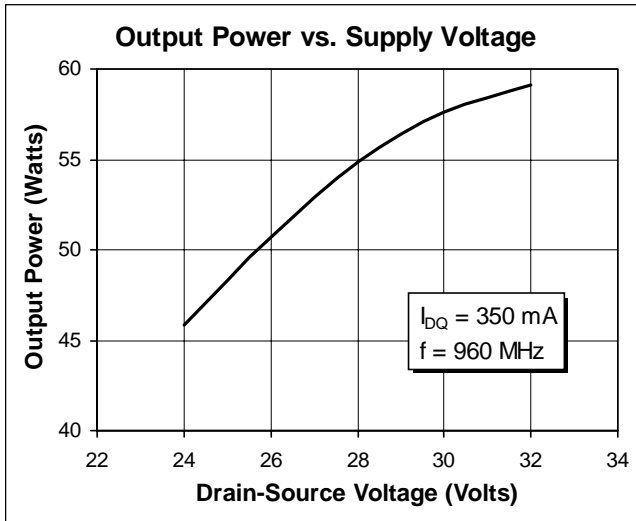

Impedance Data (circuit optimized at 960 MHz)

$V_{DD} = 28 \text{ V}$, $P_{OUT} = 50 \text{ W}$, $I_{DQ} = 350 \text{ mA}$

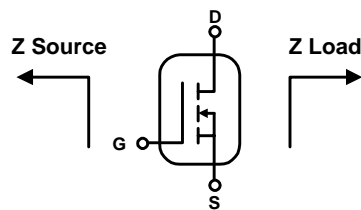

Frequency MHz	Z Source Ω		Z Load Ω	
	R	jX	R	jX
850	1.38	-1.22	2.50	1.00
900	1.20	-0.44	2.45	1.65
950	1.08	+0.67	2.40	2.33
1000	0.96	+1.30	2.40	2.90

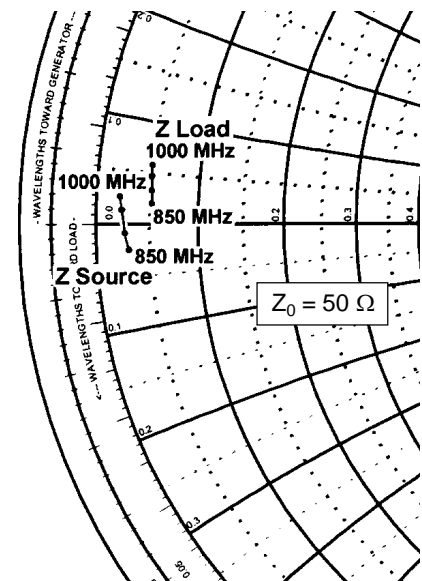

Typical Scattering Parameters

($V_{DS} = 28\text{ V}$, $I_D = 1.0\text{ A}$)

f (MHz)	S11		S21		S12		S22	
	Mag	Ang	Mag	Ang	Mag	Ang	Mag	Ang
40	0.883	-153	33.0	93	0.014	3	0.527	-143
60	0.878	-160	21.8	85	0.013	1	0.533	-148
80	0.876	-163	16.1	80	0.012	-6	0.553	-150
100	0.884	-164	12.8	76	0.012	-13	0.574	-148
150	0.904	-165	8.21	65	0.011	-18	0.638	-148
200	0.915	-165	5.67	58	0.010	-23	0.694	-149
250	0.934	-164	4.36	51	0.010	-31	0.769	-148
300	0.947	-164	3.41	45	0.010	-31	0.792	-149
350	0.962	-163	2.78	41	0.008	-28	0.837	-150
400	0.975	-163	2.30	36	0.008	-33	0.873	-151
450	0.974	-163	1.90	33	0.006	-36	0.874	-151
500	0.977	-163	1.65	30	0.006	-52	0.912	-152
550	0.979	-164	1.44	27	0.005	-46	0.916	-154
600	0.985	-164	1.28	26	0.004	-53	0.925	-154
650	0.981	-165	1.14	22	0.003	-27	0.933	-156
700	0.980	-166	1.01	21	0.004	-18	0.933	-157
750	0.975	-167	0.924	19	0.003	-13	0.936	-158
800	0.973	-168	0.809	16	0.001	14	0.946	-160
850	0.972	-170	0.749	14	0.003	-1	0.939	-160
900	0.969	-171	0.656	12	0.003	30	0.946	-162
950	0.966	-173	0.609	14	0.002	53	0.948	-164
1000	0.969	-174	0.564	8	0.003	59	0.945	-164
1050	0.969	-176	0.526	3	0.004	56	0.949	-167
1100	0.970	-177	0.450	6	0.004	69	0.955	-167
1150	0.970	-178	0.405	1	0.005	57	0.953	-168
1200	0.970	-179	0.383	4	0.005	65	0.952	-169
1250	0.971	180	0.351	-5	0.005	56	0.959	-170
1300	0.971	179	0.330	-5	0.005	61	0.957	-170
1350	0.973	179	0.308	-5	0.005	52	0.963	-171
1400	0.973	179	0.255	-3	0.006	59	0.965	-171
1450	0.972	179	0.219	5	0.006	58	0.965	-171
1500	0.965	179	0.210	-8	0.006	62	0.957	-172

Test Circuit

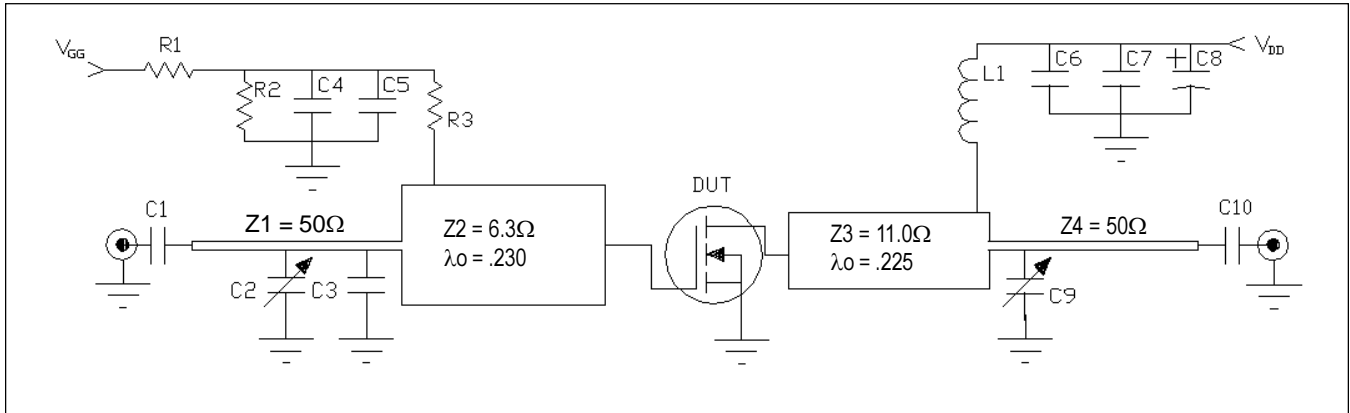

Test Circuit Schematic for $f = 960$ MHz

- DUT PTF 10031
- C1, C10 36 pF, Capacitor ATC 100 B
- C2, C9 0.3-3.5 pF, Variable Capacitor, Johanson
- C3 5.6 pF, Capacitor ATC 100 B
- C4 0.01 μ F, Capacitor ATC 10,000 B
- C5, C6 51 pF, Capacitor ATC 100 B
- C7 0.1 μ F, 50 V, Capacitor Digi-Key P4917-ND
- C8 100 μ F, 50 V, Electrolytic Capacitor, Digi-Key P5276
- L1 4 Turn, #20 AWG, .120" I.D.
- R1, R2 560 Ω , 1/4 W Resistor
- R3 330 Ω , 1/4 W Resistor
- Circuit Board .028" Dielectric Thickness, $\epsilon_r = 4.0$, AlliedSignal, G200, 2 oz. copper

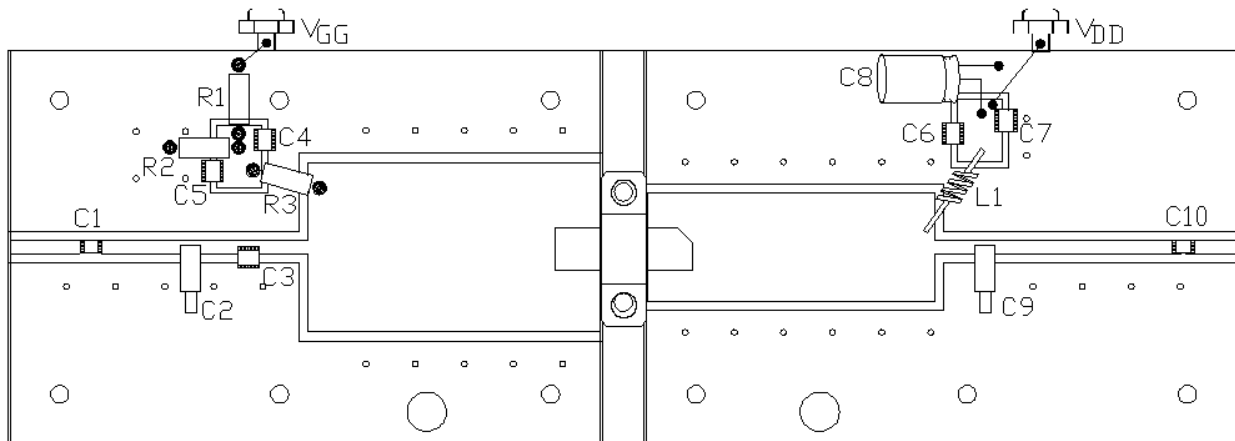

Placement Diagram

Test Circuit

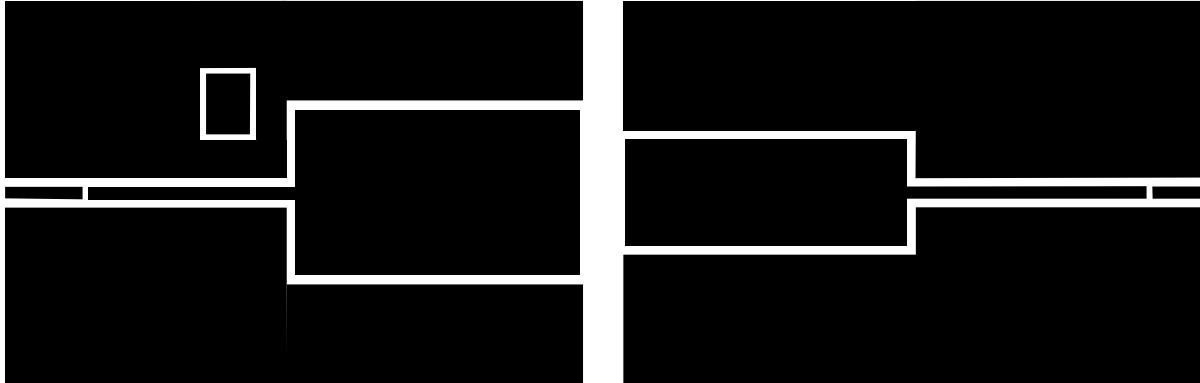

Artwork (1 inch )