

# PTF 10065

## 30 Watts, 1.93–1.99 GHz

### GOLDMOS® Field Effect Transistor

#### Description

The PTF 10065 is a 30-watt GOLDMOS FET intended for PCS amplifier applications from 1.93 to 1.99 GHz. It typically operates with 11 dB gain. Nitride surface passivation and full gold metallization ensure excellent device lifetime and reliability.

- **INTERNALLY MATCHED**
- **Guaranteed Performance at 1.99 GHz, 28 V**  
- Output Power = 30 Watts Min  
- Power Gain = 11.0 dB Typ
- **Full Gold Metallization**
- **Silicon Nitride Passivated**
- **Excellent Thermal Stability**
- **100% Lot Traceability**

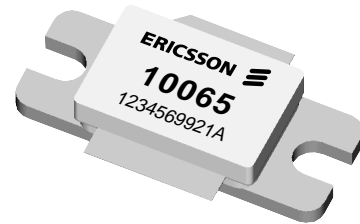
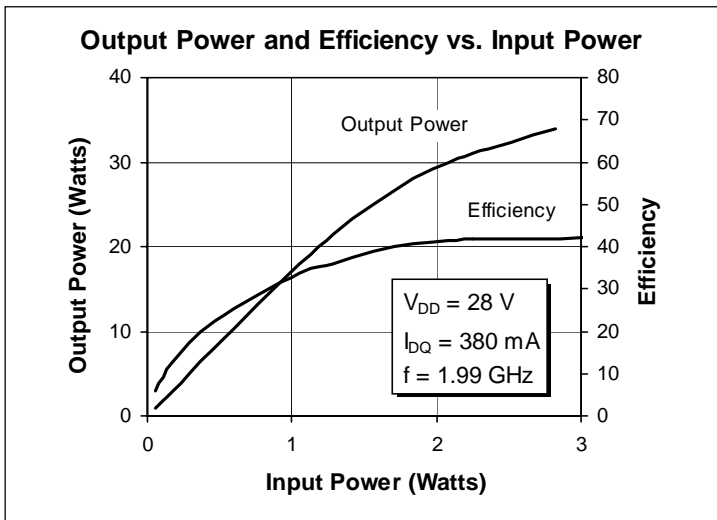

Package 20237

#### RF Specifications (100% Tested)

Characteristic	Symbol	Min	Typ	Max	Units
<b>Gain</b> ( $V_{DD} = 28\text{ V}$ , $P_{OUT} = 3\text{ W}$ , $I_{DQ} = 380\text{ mA}$ , $f = 1.93, 1.99\text{ GHz}$ )	$G_{ps}$	—	11.0	—	dB
<b>ACPR (40 Walsh Codes)</b> ( $V_{DD} = 28\text{ V}$ , $P_{OUT} = 3\text{ W(CDMA)}$ , $I_{DQ} = 380\text{ mA}$ , $f = 1.99\text{ GHz}$ )	$\pm 885\text{ KHz}$ ACPR	- 50	—	—	dBc
( $V_{DD} = 28\text{ V}$ , $P_{OUT} = 3\text{ W(CDMA)}$ , $I_{DQ} = 380\text{ mA}$ , $f = 1.99\text{ GHz}$ )	$\pm 1.98\text{ MHz}$ ACPR	- 62	—	—	dBc
<b>Gain Flatness</b> ( $V_{DD} = 28\text{ V}$ , $P_{OUT} = 3\text{ W}$ , $I_{DQ} = 380\text{ mA}$ , $f = 1.930\text{--}1.990\text{ GHz}$ )	$G_{\Delta f}$	—	—	0.7	dB
<b>Drain Efficiency</b> ( $V_{DD} = 28\text{ V}$ , $P_{OUT} = 3\text{ W}$ , $I_{DQ} = 380\text{ mA}$ , $f = 1.99\text{ GHz}$ )	$\eta_D$	9	—	—	%

All published data at  $T_{CASE} = 25^\circ\text{C}$  unless otherwise indicated.

(table continues next page)

## RF Specifications (cont.) (100% Tested)

Characteristic	Symbol	Min	Typ	Max	Units
<b>Power Output at 1 dB Compressed</b> ( $V_{DD} = 28\text{ V}$ , $I_{DQ} = 380\text{ mA}$ , $f = 1.99\text{ GHz}$ )	P-1dB	30	—	—	Watts
<b>Load Mismatch Tolerance</b> ( $V_{DD} = 28\text{ V}$ , $P_{OUT} = 30\text{ W}$ , $I_{DQ} = 380\text{ mA}$ , $f = 1.99\text{ GHz}$ —all phase angles at frequency of test)	$\Psi$	—	—	10:1	—
<b>Input Return Loss</b> ( $V_{DD} = 28\text{ V}$ , $P_{OUT} = 3\text{ W}$ , $I_{DQ} = 380\text{ mA}$ , $f = 1.93, 1.99\text{ GHz}$ )	Rtn Loss	10	—	—	dB
<b>Insertion Phase (Referenced to Correlation Devices)</b> ( $V_{DD} = 28\text{ V}$ , $P_{OUT} = 3\text{ W}$ , $I_{DQ} = 380\text{ mA}$ , $f = 1.96\text{ GHz}$ )	$\phi$	-10	—	+10	Deg.

## Electrical Characteristics (cont.) (100% Tested)

Characteristic	Conditions	Symbol	Min	Typ	Max	Units
Drain-Source Breakdown Voltage	$V_{GS} = 0\text{ V}$ , $I_D = 25\text{ mA}$	$V_{(BR)DSS}$	62	—	—	Volts
Zero Gate Voltage Drain Current	$V_{DS} = 28\text{ V}$ , $V_{GS} = 0\text{ V}$	$I_{DSS}$	—	—	1.0	mA
Gate Threshold Voltage	$V_{DS} = 10\text{ V}$ , $I_D = 75\text{ mA}$	$V_{GS(th)}$	—	3.8	—	Volts
Forward Transconductance	$V_{DS} = 10\text{ V}$ , $I_D = 6\text{ A}$	$g_{fs}$	—	1.8	—	Siemens
Gate-Source Leakage	$V_{GS} = 10\text{ V}$	$I_{GSSf}$	—	—	1	$\mu\text{A}$
Gate Quiescent Voltage	$V_{DS} = 28\text{ V}$ , $I_D = 380\text{ mA}$	$V_{GS(q)}$	3.0	—	5.0	V

## Maximum Ratings

Parameter	Symbol	Value	Unit
Drain-Source Voltage	$V_{DSS}$	62	Vdc
Gate-Source Voltage	$V_{GS}$	$\pm 20$	Vdc
Operating Junction Temperature	$T_J$	200	$^{\circ}\text{C}$
Total Device Dissipation Above $25^{\circ}\text{C}$ derate by	$P_D$	120 0.7	Watts $\text{W}/^{\circ}\text{C}$
Storage Temperature Range	$T_{STG}$	-40 to +150	$^{\circ}\text{C}$
Thermal Resistance ( $T_{CASE} = 70^{\circ}\text{C}$ )	$R_{\theta JC}$	1.4	$^{\circ}\text{C}/\text{W}$

**Typical Performance**

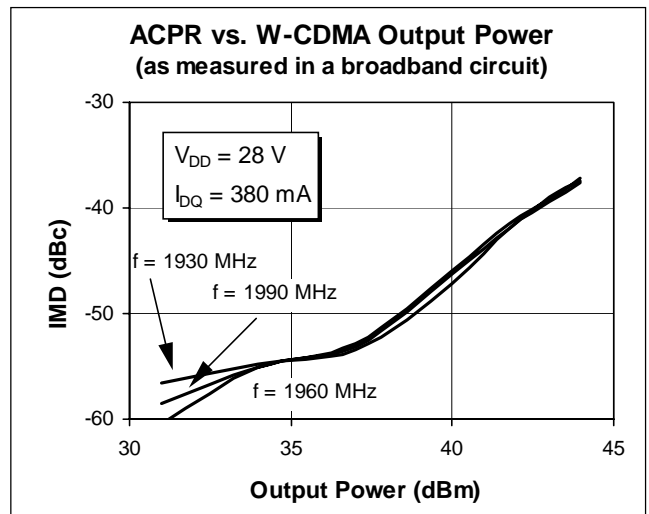
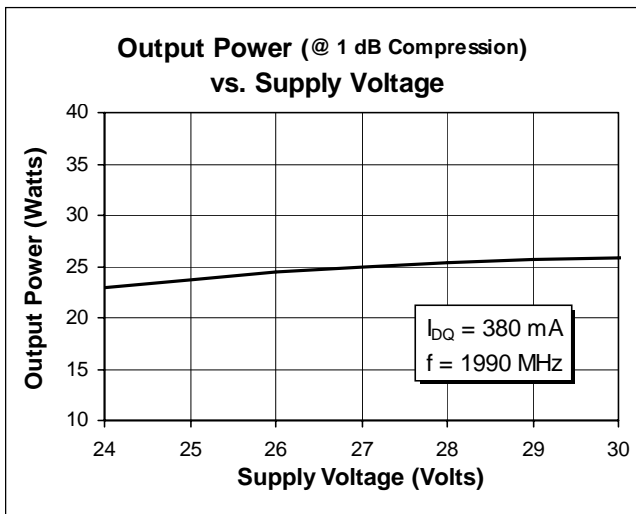
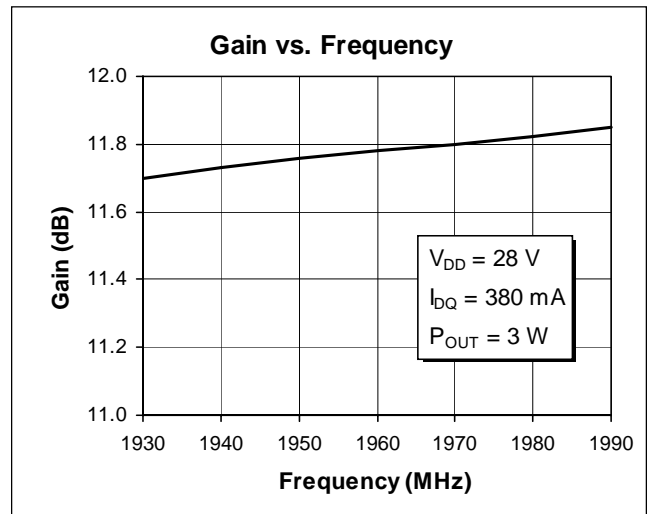
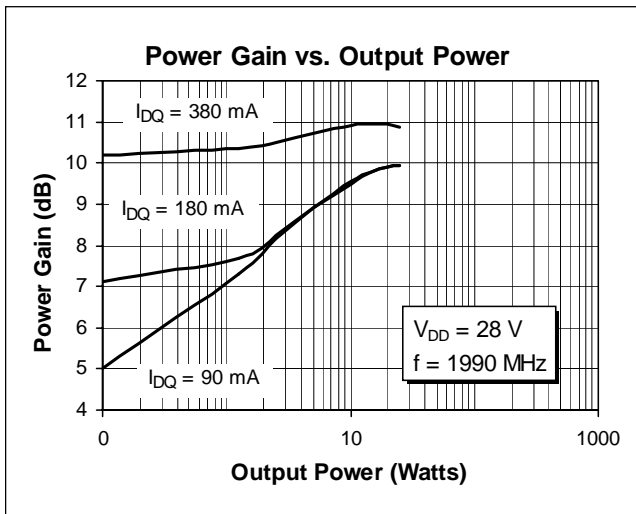
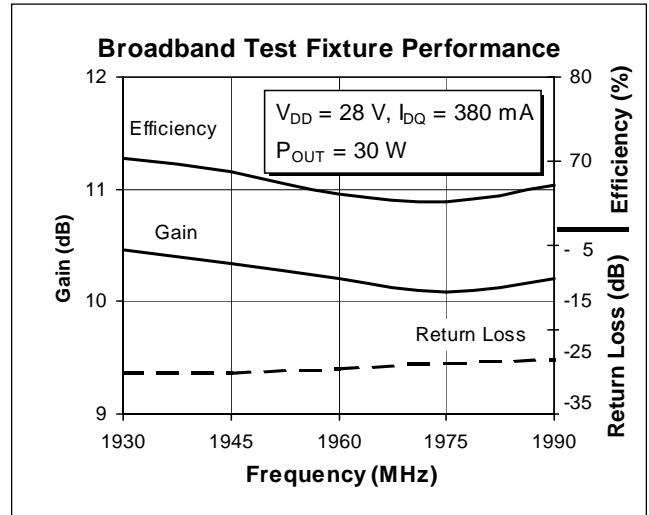
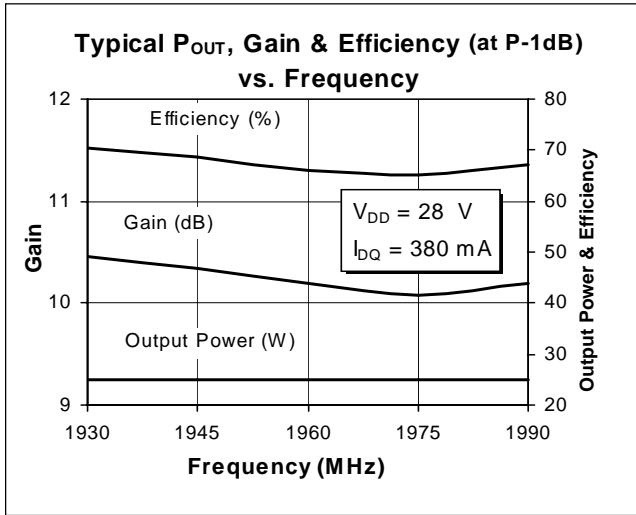

## Typical Performance (cont.)

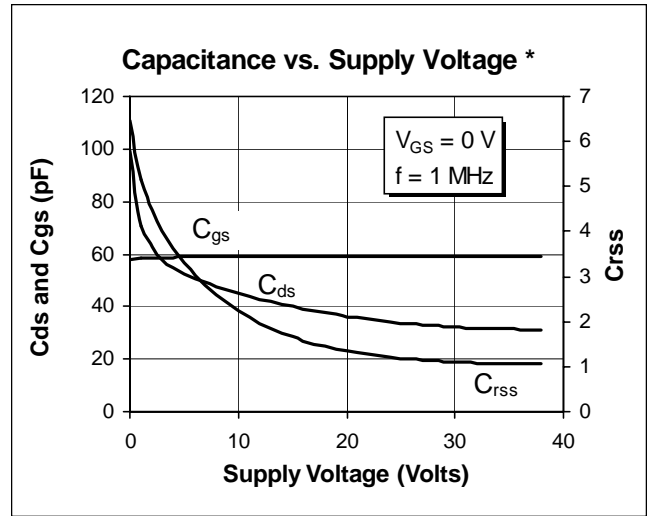
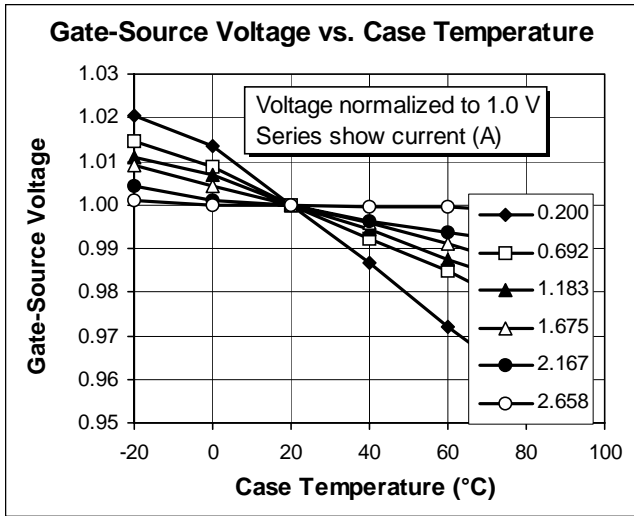

\* This part is internally matched. Measurements of the finished product will not yield these results.

## Impedance Data

( $V_{DD} = 28\text{ V}$ ,  $P_{OUT} = 30\text{ W}$ ,  $I_{DQ} = 380\text{ mA}$ )

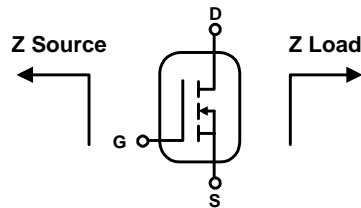

Frequency MHz	Z Source $\Omega$		Z Load $\Omega$	
	R	jX	R	jX
1930	11.2	-10.50	2.79	-4.32
1945	11.8	-9.23	2.62	-4.23
1960	12.4	-8.01	2.45	-4.14
1975	13.0	-6.79	2.27	-4.05
1990	13.6	-5.56	2.10	-3.96

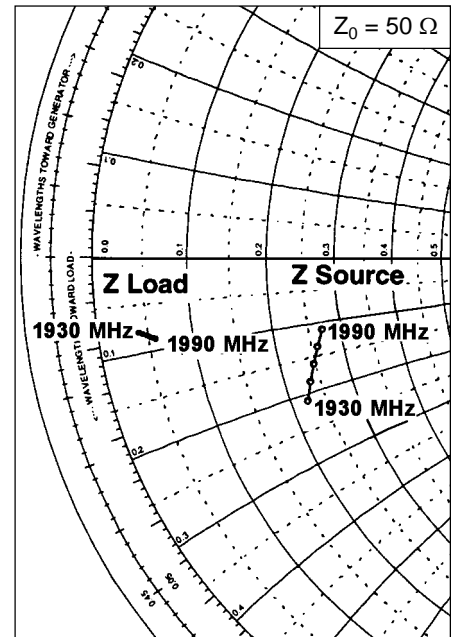

**Test Circuit**

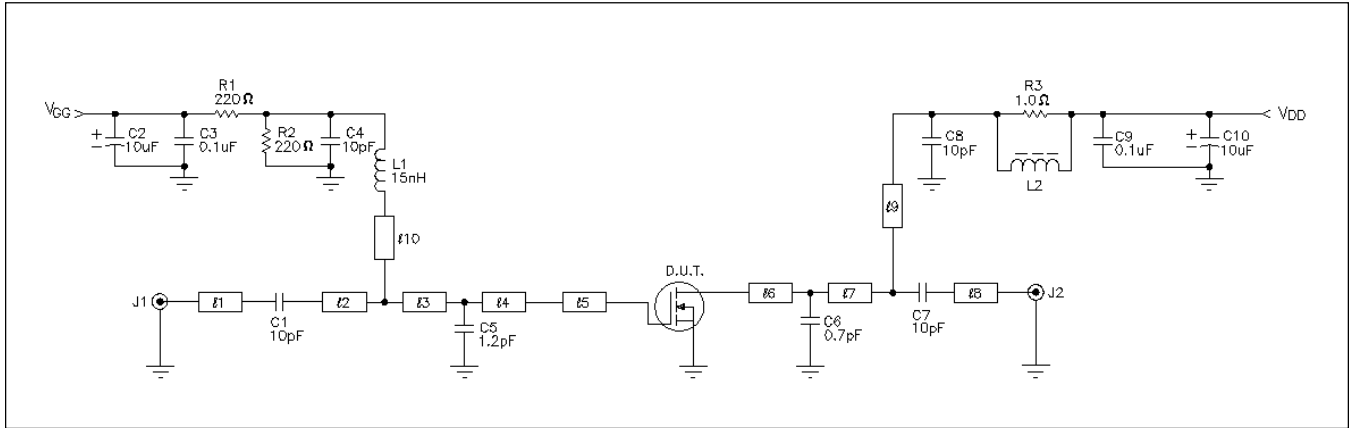

*Test Circuit Schematic for  $f = 1990$  MHz*

DUT	PTF 10065	LDMOS Transistor
l1	0.072 λ 1990 MHz	Microstrip 50 Ω
l2	0.118 λ 1990 MHz	Microstrip 50 Ω
l3	0.063 λ 1990 MHz	Microstrip 50 Ω
l4	0.043 λ 1990 MHz	Microstrip 50 Ω
l5	0.045 λ 1990 MHz	Microstrip 11.23 Ω
l6	0.097 λ 1990 MHz	Microstrip 9.97 Ω
l7	0.028 λ 1990 MHz	Microstrip 9.97 Ω
l8	0.244 λ 1990 MHz	Microstrip 50 Ω
l9	0.250 λ 1990 MHz	Microstrip 67.35 Ω
l10	0.110 λ 1990 MHz	Microstrip 80.25 Ω

C2, C10	Capacitor, 10 μF, 35V	Digi-Key PC56106-ND
C3	Capacitor, 0.1 μF	Digi-Key P4525-ND
C4, C8, C1, C7	Capacitor, 10pF	100B 100
C5	Capacitor, 1.2 pF	100B 1R2
C6	Capacitor, 0.7 pF	100B 0R7
C9	Capacitor, 0.1 μF	ATC 200B
J1, J2	Connector, SMA, Female, Panel Mount	
L1	Inductor, 15 nH	
L2	4 mm Ferrite Bead	Philips BD 53/3/4.6-452
R1, R2	Resistor, 220 ohm 1/4W	Digi-Key P220ECT-ND
R3	Resistor, 1.0 ohm	Digi-Key P1.0 ECT
PCB	0.031" Thick, 2 oz Copper Both Sides, AlliedSignal G200	

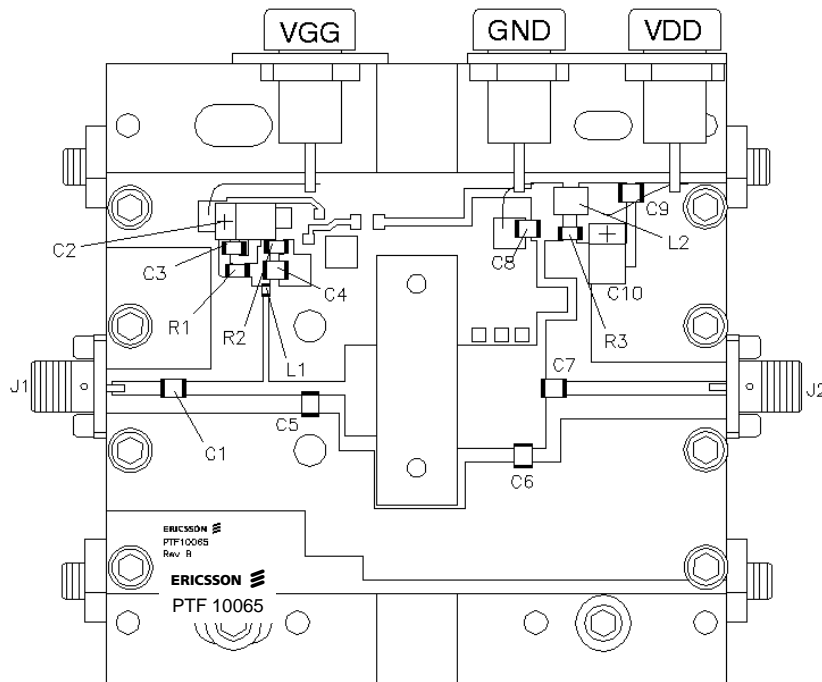

*Assembly Diagram (not to scale)*

# PTF 10065



## Test Circuit (cont.)

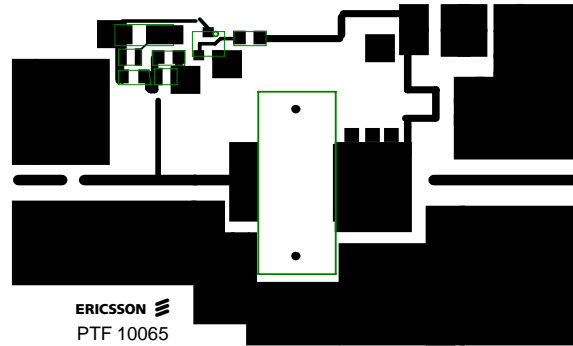

*Artwork (not to scale)*