

PTF 10136

6 Watts, 1.0 GHz

GOLDMOS Field Effect Transistor

Description

The PTF 10136 is a 6-watt GOLDMOS FET intended for large signal amplifier applications from to 1.0 GHz. It operates at 57% efficiency with 19 dB typical gain. Nitride surface passivation and full gold metallization ensure excellent device lifetime and reliability.

- Performance at 960 MHz, 28 Volts
 - Output Power = 6 Watts
 - Efficiency = 57% Typ
 - Power Gain = 19 dB Typ
- Full Gold Metallization
- Silicon Nitride Passivated
- Surface Mountable
- Available in Tape and Reel
- 100% Lot Traceability

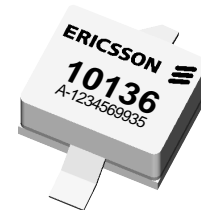
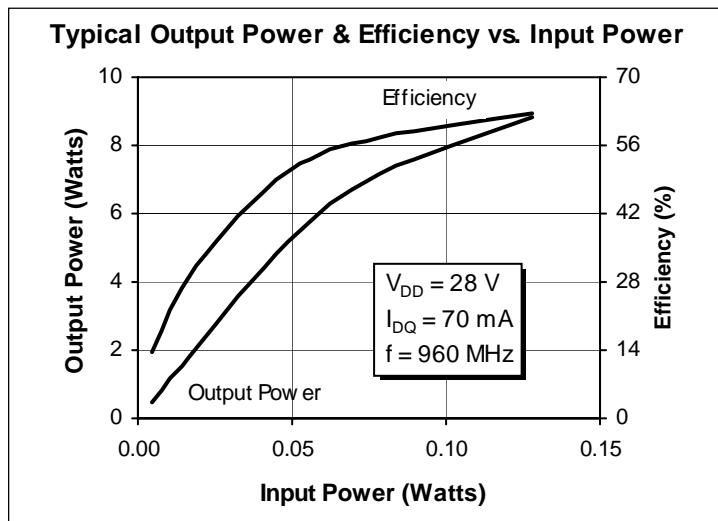

Package 20244

RF Specifications (100% Tested)

Characteristic	Symbol	Min	Typ	Max	Units
Common Source Power Gain ($V_{DD} = 28\text{ V}$, $P_{OUT} = 1\text{ W}$, $I_{DQ} = 70\text{ mA}$, $f = 960\text{ MHz}$)	G_{ps}	18	19	—	dB
Power Output at 1 dB Compressed ($V_{DD} = 28\text{ V}$, $I_{DQ} = 70\text{ mA}$, $f = 960\text{ MHz}$)	P-1dB	6.0	7.5	—	Watts
Drain Efficiency ($V_{DD} = 28\text{ V}$, $P_{OUT} = 6\text{ W}$, $I_{DQ} = 70\text{ mA}$, $f = 960\text{ MHz}$)	η	50	57	—	%
Load Mismatch Tolerance ($V_{DD} = 28\text{ V}$, $P_{OUT} = 6\text{ W}$, $I_{DQ} = 70\text{ mA}$, $f = 960\text{ MHz}$ — all phase angles at frequency of test)	Ψ	—	—	10:1	—

All published data at $T_{CASE} = 25^\circ\text{C}$ unless otherwise indicated.

Electrical Characteristics (100% Tested)

Characteristic	Conditions	Symbol	Min	Typ	Max	Units
Drain-Source Breakdown Voltage	$V_{GS} = 0\text{ V}, I_D = 25\text{ mA}$	$V_{(BR)DSS}$	65	—	—	Volts
Drain-Source Leakage Current	$V_{DS} = 28\text{ V}, V_{GS} = 0\text{ V}$	I_{DSS}	—	—	1	mA
Gate Threshold Voltage	$V_{DS} = 10\text{ V}, I_D = 75\text{ mA}$	$V_{GS(th)}$	3.0	—	5.0	Volts
Forward Transconductance	$V_{DS} = 10\text{ V}, I_D = 0.5\text{ A}$	g_{fs}	—	0.3	—	Siemens

Maximum Ratings

Parameter	Symbol	Value	Unit
Drain-Source Voltage	V_{DSS}	65	Vdc
Gate-Source Voltage	V_{GS}	± 20	Vdc
Operating Junction Temperature	T_J	200	$^{\circ}\text{C}$
Total Device Dissipation Above 25°C derate by	P_D	39 0.22	Watts $\text{W}/^{\circ}\text{C}$
Storage Temperature Range	T_{STG}	-40 to +150	$^{\circ}\text{C}$
Thermal Resistance ($T_{CASE} = 70^{\circ}\text{C}$)	$R_{\theta JC}$	4.5	$^{\circ}\text{C}/\text{W}$

Typical Performance

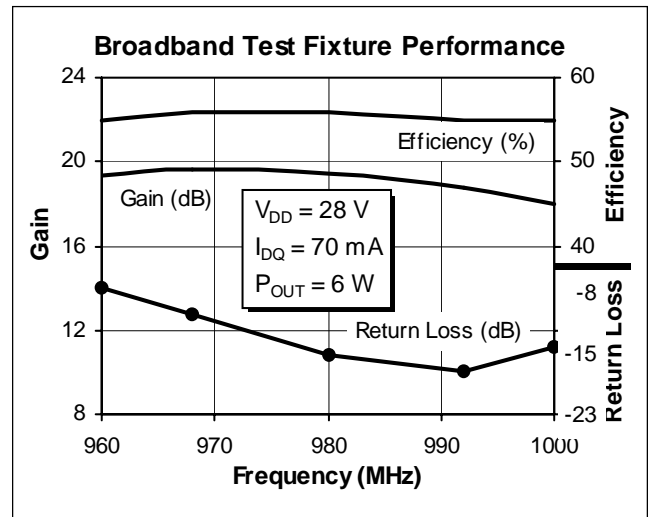
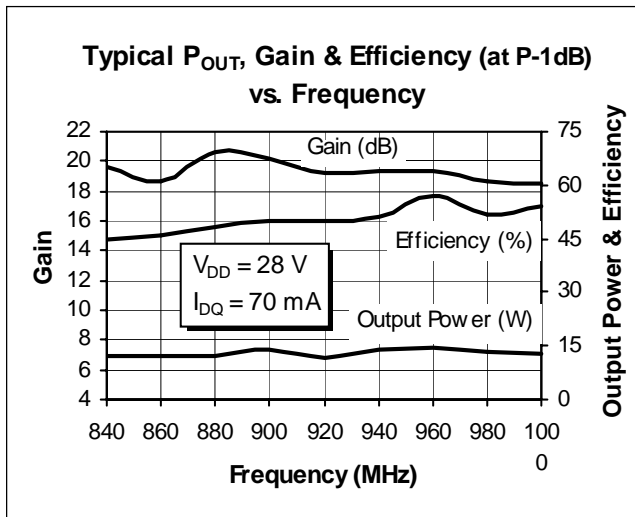

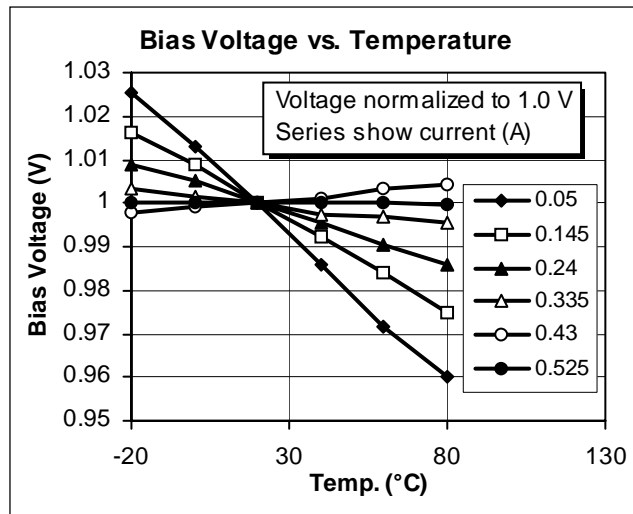
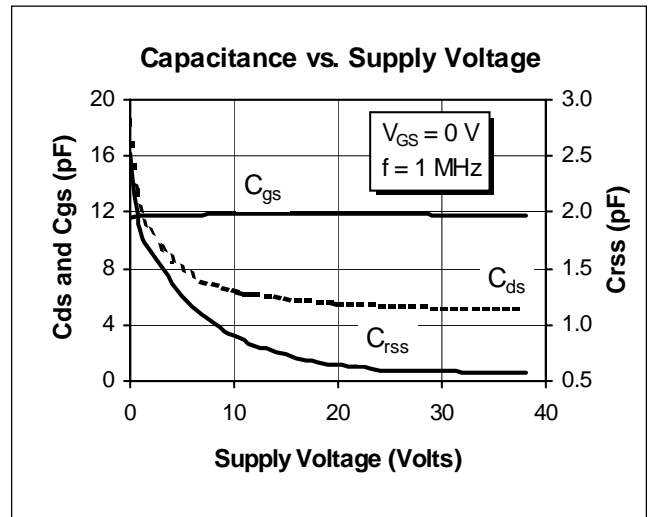
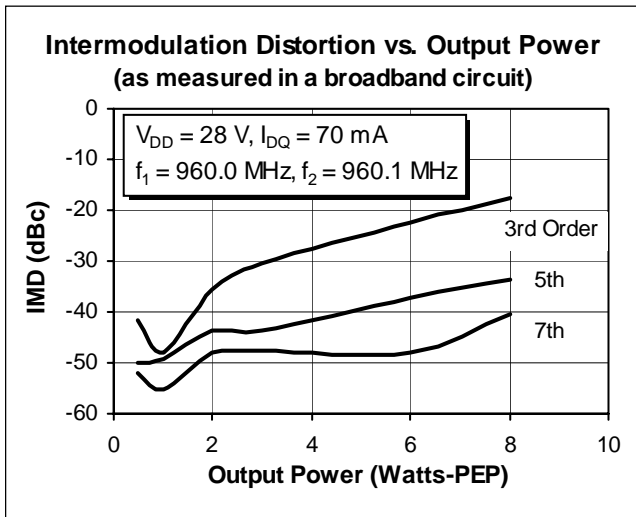
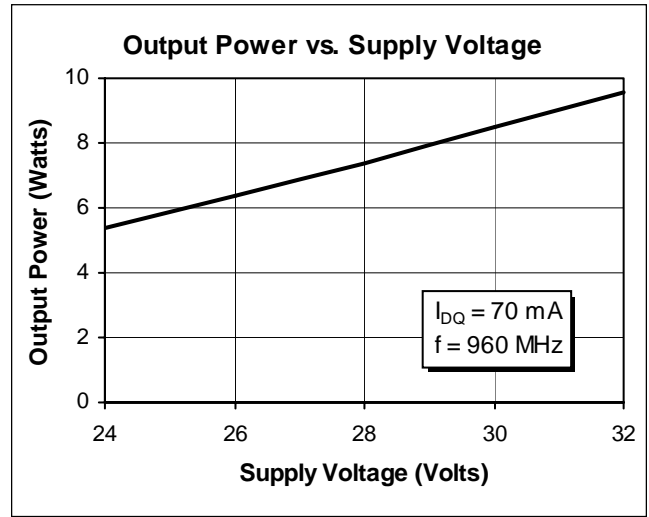
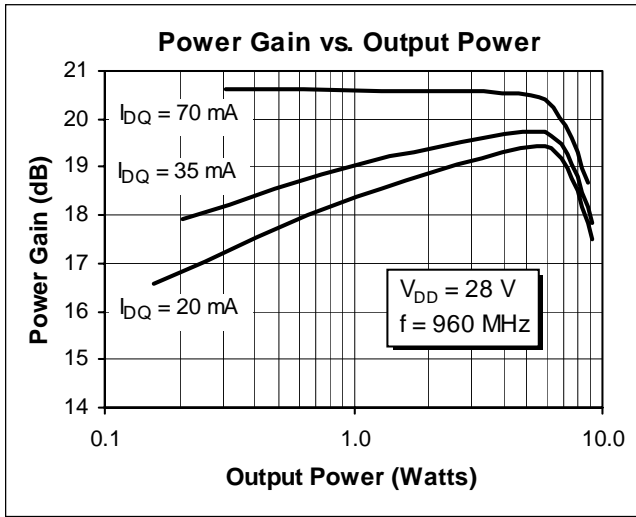

PTF 10136



Impedance Data

$V_{DD} = 28\text{ V}$, $I_{DQ} = 70\text{ mA}$, $P_{-1\text{dB}} = 6\text{ W}$

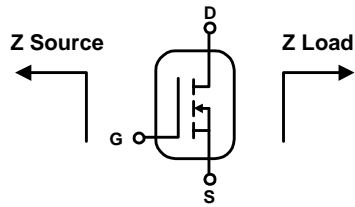

Frequency MHz	Z Source Ω		Z Load Ω	
	R	jX	R	jX
840	1.6	7.2	8.9	15.0
860	1.4	7.1	9.2	13.1
880	1.4	7.1	9.7	12.6
900	1.3	6.9	9.6	12.5
920	1.2	6.8	10.4	11.9
940	1.2	5.7	10.6	11.7
960	1.3	5.5	14.3	11.1
980	1.4	5.1	14.4	11.2
1000	1.7	4.9	16.3	11.1

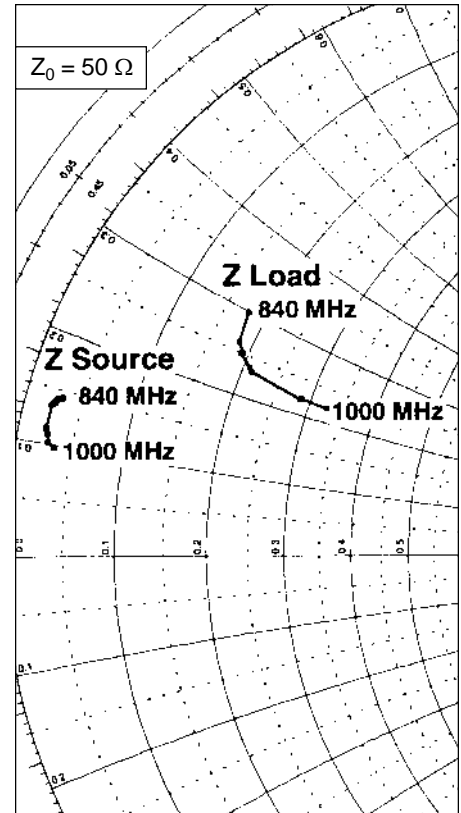

Typical Scattering Parameters
(V_{DS} = 28 V, I_D = 200 mA)

f (MHz)	S11		S21		S12		S22	
	Mag	Ang	Mag	Ang	Mag	Ang	Mag	Ang
100	0.962	-65.3	22.2	138	0.016	48.1	0.888	-31.8
150	0.925	-78.2	20.0	129	0.018	39.0	0.853	-37.7
200	0.918	-95.7	17.4	116	0.021	28.5	0.810	-46.7
250	0.913	-109	15.0	106	0.022	19.7	0.776	-54.3
300	0.906	-120	13.0	96.8	0.023	12.4	0.754	-61.2
350	0.900	-128	11.4	89.2	0.023	6.10	0.742	-67.1
400	0.896	-134	9.98	82.5	0.022	0.77	0.737	-72.9
450	0.894	-140	8.84	76.4	0.022	-3.81	0.735	-78.3
500	0.895	-144	7.90	70.9	0.021	-7.93	0.739	-83.4
550	0.896	-148	7.09	65.9	0.020	-11.6	0.743	-88.4
600	0.897	-152	6.41	61.1	0.019	-15.0	0.752	-93.2
650	0.901	-155	5.85	56.9	0.018	-17.5	0.763	-97.5
700	0.900	-158	5.33	52.7	0.017	-19.8	0.771	-102
750	0.905	-160	4.89	48.7	0.015	-21.4	0.782	-106
800	0.908	-162	4.49	45.0	0.014	-22.9	0.787	-110
850	0.910	-165	4.14	41.2	0.013	-24.2	0.797	-113
900	0.917	-167	3.85	37.8	0.012	-24.3	0.808	-117
950	0.916	-169	3.56	34.6	0.011	-24.3	0.817	-120
1000	0.919	-171	3.31	31.2	0.009	-22.7	0.828	-123
1050	0.923	-172	3.09	28.4	0.008	-20.5	0.833	-126
1100	0.925	-174	2.88	25.2	0.007	-16.5	0.841	-129
1150	0.932	-176	2.70	22.4	0.006	-10.7	0.849	-132
1200	0.929	-177	2.53	19.7	0.006	-1.76	0.855	-135
1250	0.930	-179	2.38	16.8	0.005	9.41	0.864	-138
1300	0.934	180	2.24	14.5	0.005	22.3	0.871	-140
1350	0.935	178	2.10	11.9	0.005	33.2	0.875	-142
1400	0.943	177	2.00	9.38	0.005	43.6	0.883	-145
1450	0.942	176	1.89	7.16	0.006	52.3	0.883	-147
1500	0.942	174	1.80	4.51	0.007	59.0	0.891	-149
1550	0.946	173	1.71	2.46	0.008	64.1	0.897	-151
1600	0.943	171	1.62	-0.02	0.009	67.2	0.902	-153
1650	0.951	170	1.55	-2.40	0.010	69.7	0.911	-155
1700	0.951	169	1.48	-4.21	0.011	71.9	0.911	-157
1750	0.951	167	1.41	-6.51	0.012	72.2	0.911	-159
1800	0.952	166	1.35	-8.48	0.013	72.5	0.912	-161
1850	0.947	165	1.28	-10.8	0.014	72.0	0.911	-163
1900	0.951	163	1.24	-13.0	0.015	71.8	0.920	-165
1950	0.951	162	1.18	-14.7	0.017	71.9	0.920	-166
2000	0.949	161	1.13	-16.8	0.018	71.3	0.923	-168
2050	0.953	160	1.09	-18.7	0.019	71.1	0.925	-170
2100	0.947	159	1.05	-20.8	0.020	70.4	0.922	-171
2150	0.950	157	1.01	-22.9	0.021	69.4	0.929	-173
2200	0.946	156	0.982	-24.2	0.022	68.6	0.930	-175

PTF 10136



Test Circuit

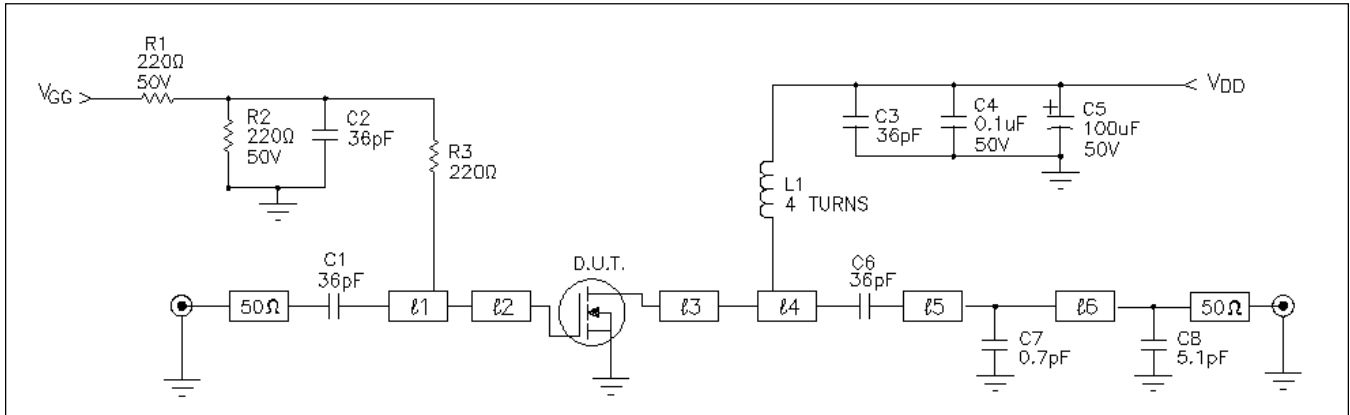

Test Circuit Schematic for $f=960$ MHz

DUT	PTF 10136	LDMOS Transistor
$l1$	0.221λ	960 MHz Microstrip 8.9Ω
$l2, l3$	0.020λ	960 MHz Microstrip 41.0Ω
$l4$	0.190λ	960 MHz Microstrip 14.1Ω
$l5$	0.024λ	960 MHz Microstrip 50Ω
$l6$	0.034λ	960 MHz Microstrip 50Ω

C1, C2, C3, C6	36 pF, Capacitor ATC 100 B
C4	0.1μF, 50 V, Capacitor Digi-Key P4525-ND
C5	100 μF, 50 V, Capacitor, Digi-Key P5782-ND
C7	0.7 μF ATC 100 B
C8	5.1μF ATC 100 B
J1, J2	Connector, SMA, Female, Panel Mount N/A
L1	4 Turns, 22 AWG, .085 Dia I.D. Magnet Wire N/A
R1, R2, R3	Resistor, 220ohm, 1/4W Digi-Key 2.2QBK
Circuit Board	.031" thick, $\epsilon_r = 4.0$, G200, AlliedSignal, 2 oz. copper

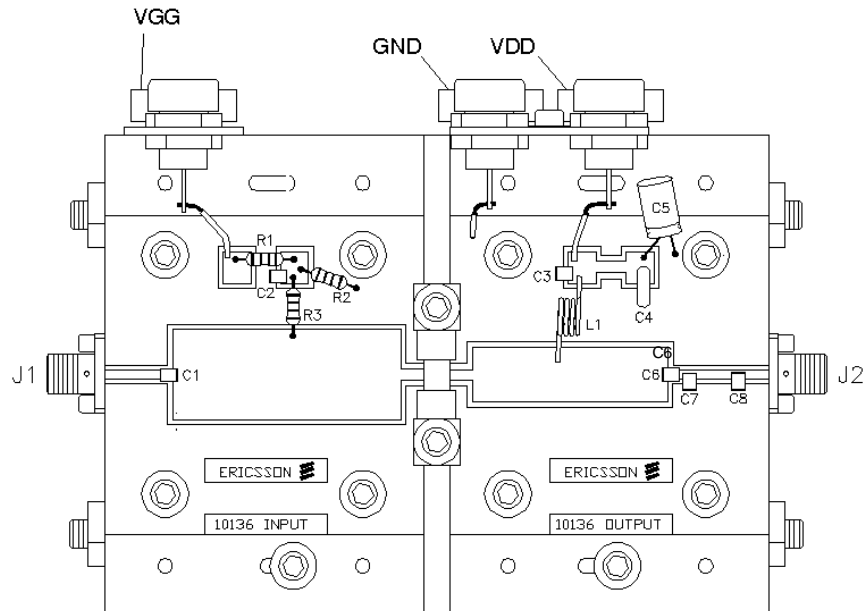

Placement Diagram (not to scale)

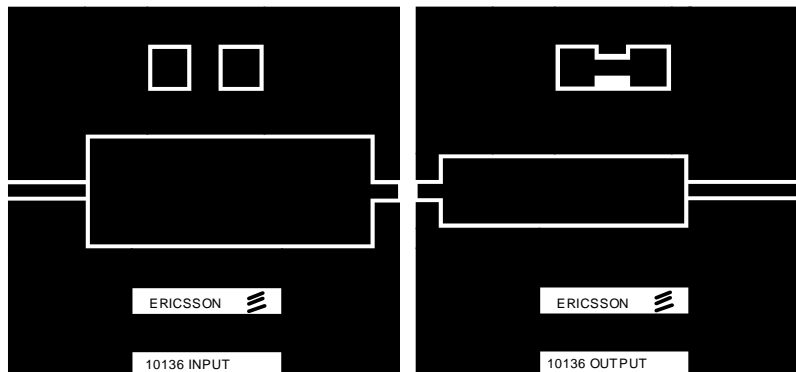

Artwork (not to scale)

Case Outline Specifications

