

PTF 10193

12 Watts, 860-960 MHz

GOLDMOS Field Effect Transistor

Description

The PTF 10193 is an internally matched, 12-watt GOLDMOS FET intended for GSM, CDMA and TDMA amplifier applications from 860 to 960 MHz. This device operates at 60% efficiency with 18 dB typical gain. Nitride surface passivation and full gold metallization ensure excellent device lifetime and reliability.

- **INTERNALLY MATCHED**
- **Performance at 960 MHz, 26 Volts**
 - Output Power = 12 Watts
 - Efficiency = 60% Typ
 - Power Gain = 18 dB Typ
- **Full Gold Metallization**
- **Silicon Nitride Passivated**
- **Surface Mountable**
- **Available in Tape and Reel**
- **100% Lot Traceability**

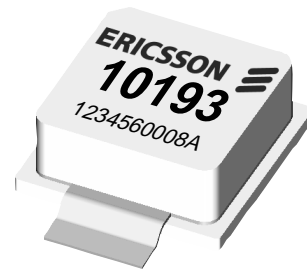
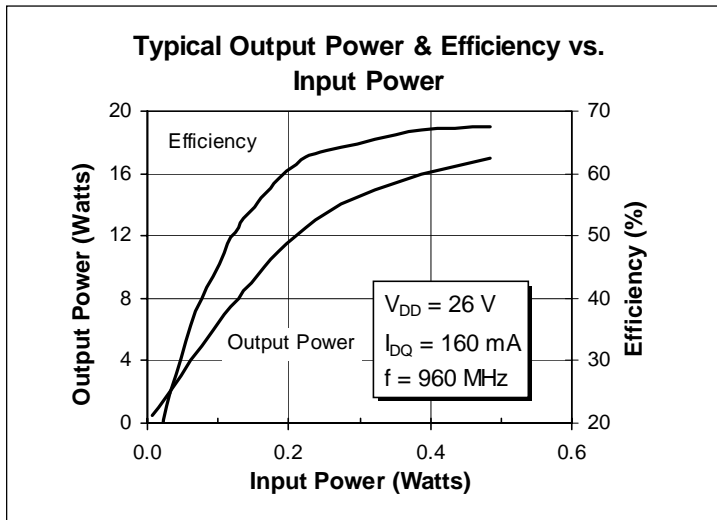

Package 20259

RF Specifications (100% Tested)

Characteristic	Symbol	Min	Typ	Max	Units
Common Source Power Gain ($V_{DD} = 26\text{ V}$, $P_{OUT} = 12\text{ W}$, $I_{DQ} = 160\text{ mA}$, $f = 960\text{ MHz}$)	G_{ps}	17.0	18	—	dB
Power Output at 1 dB Compressed ($V_{DD} = 26\text{ V}$, $I_{DQ} = 160\text{ mA}$, $f = 960\text{ MHz}$)	P-1dB	12	14	—	Watts
Drain Efficiency ($V_{DD} = 26\text{ V}$, $P_{OUT} = 12\text{ W}$, $I_{DQ} = 160\text{ mA}$, $f = 960\text{ MHz}$)	η	55	60	—	%
Load Mismatch Tolerance ($V_{DD} = 26\text{ V}$, $P_{OUT} = 12\text{ W}$, $I_{DQ} = 160\text{ mA}$, $f = 921\text{ MHz}$ —all phase angles at frequency of test)	Ψ	—	—	10:1	—

All published data at $T_{CASE} = 25^\circ\text{C}$ unless otherwise indicated.

Electrical Characteristics (100% Tested)

Characteristic	Conditions	Symbol	Min	Typ	Max	Units
Drain-Source Breakdown Voltage	$V_{GS} = 0\text{ V}, I_D = 25\text{ mA}$	$V_{(BR)DSS}$	65	—	—	Volts
Drain-Source Leakage Current	$V_{DS} = 28\text{ V}, V_{GS} = 0\text{ V}$	I_{DSS}	—	—	1	mA
Gate Threshold Voltage	$V_{DS} = 10\text{ V}, I_D = 75\text{ mA}$	$V_{GS(th)}$	3.0	—	5.0	Volts
Forward Transconductance	$V_{DS} = 10\text{ V}, I_D = 0.5\text{ A}$	g_{fs}	—	0.9	—	Siemens

Maximum Ratings

Parameter	Symbol	Value	Unit
Drain-Source Voltage	V_{DSS}	65	Vdc
Gate-Source Voltage	V_{GS}	± 20	Vdc
Operating Junction Temperature	T_J	200	$^{\circ}\text{C}$
Total Device Dissipation Above 25°C derate by	P_D	58 0.33	Watts $\text{W}/^{\circ}\text{C}$
Storage Temperature Range	T_{STG}	-40 to 150	$^{\circ}\text{C}$
Thermal Resistance ($T_{CASE} = 70^{\circ}\text{C}$)	$R_{\theta JC}$	3.0	$^{\circ}\text{C}/\text{W}$

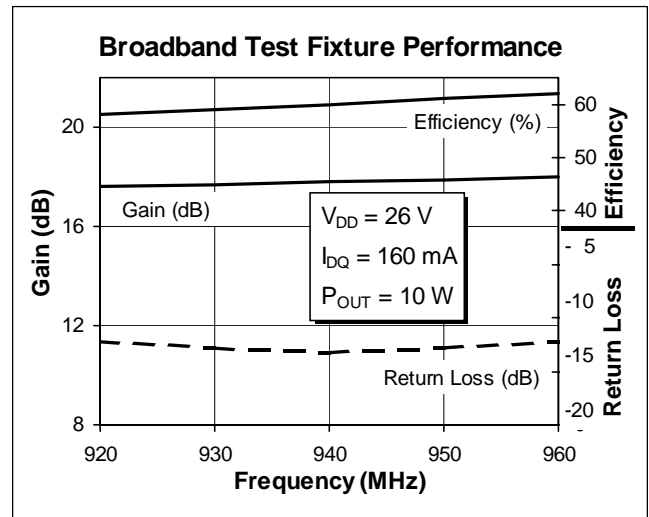
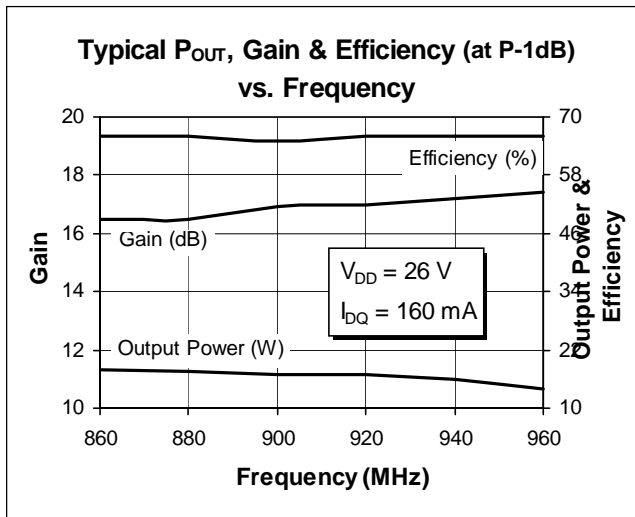

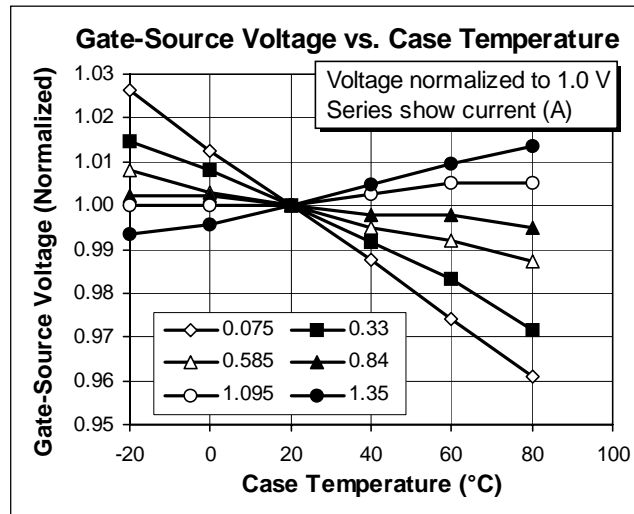
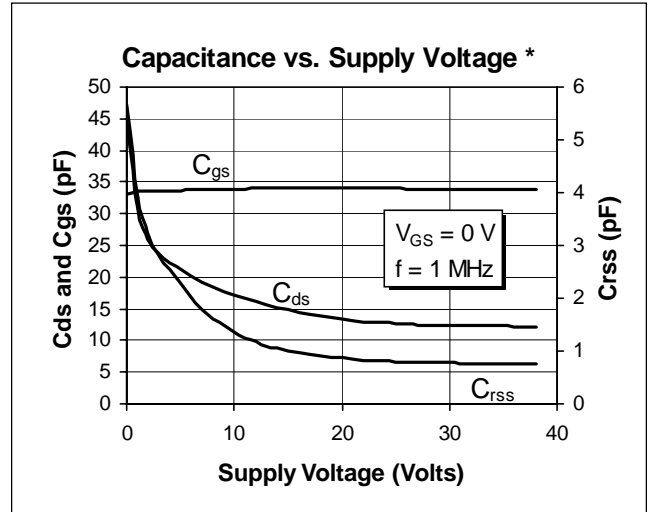
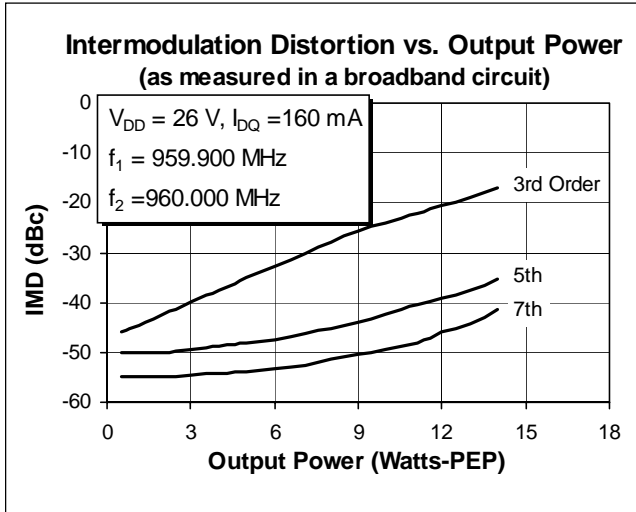
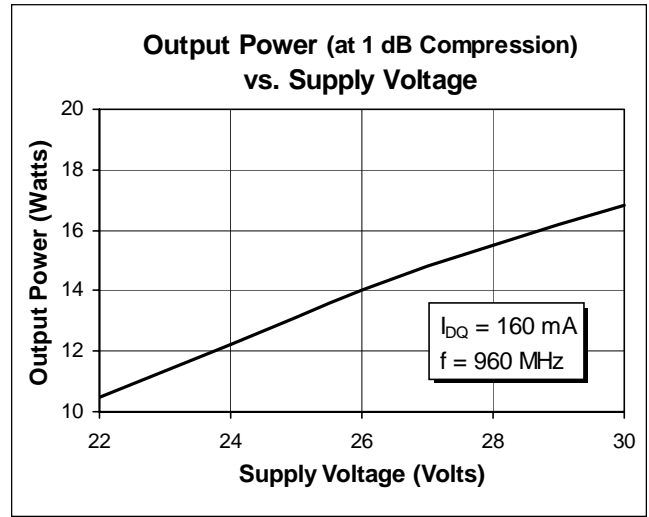
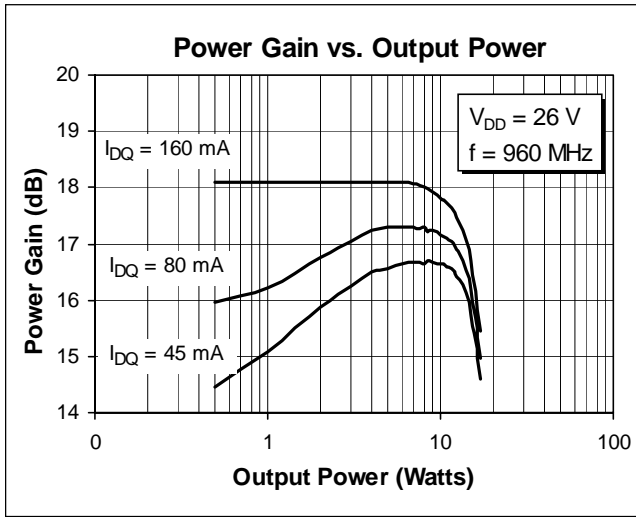

* This part is internally matched. Measurements of the finished product will not yield these figures.

Impedance Data

$V_{DD} = 26 \text{ V}$, $I_{DQ} = 160 \text{ mA}$, $P_{-1\text{dB}} = 12 \text{ W}$

Frequency MHz	Z Source Ω		Z Load Ω	
	R	jX	R	jX
860	2.0	2.7	5.8	4.4
880	2.0	2.6	5.5	4.6
900	2.0	2.4	5.0	5.0
920	1.9	2.3	4.8	5.1
960	1.9	2.1	4.7	5.3

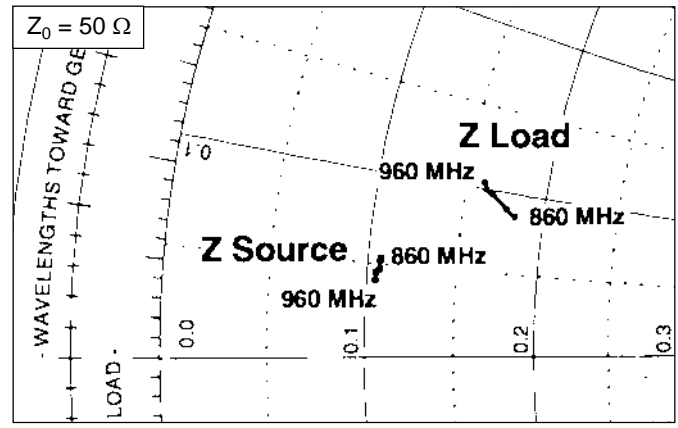
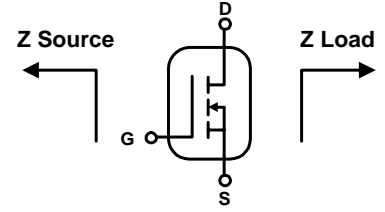

Typical Scattering Parameters

($V_{DS} = 26 \text{ V}$, $I_D = 400 \text{ mA}$)

f (MHz)	S11		S21		S12		S22	
	Mag	Ang	Mag	Ang	Mag	Ang	Mag	Ang
300	-0.284	-169	12.4	47.8	-42.7	-34.2	-1.62	-99.9
350	-0.266	-171	10.7	41.6	-43.7	-38.9	-1.34	-108
400	-0.241	-172	9.20	36.1	-44.7	-41.9	-1.24	-115
450	-0.243	-173	7.86	31.2	-45.4	-45.0	-1.08	-121
500	-0.231	-175	6.68	26.7	-46.7	-47.2	-0.958	-126
550	-0.223	-176	5.74	22.6	-47.6	-49.8	-0.852	-131
600	-0.231	-177	4.90	18.8	-48.7	-51.6	-0.818	-135
650	-0.233	-178	4.22	14.9	-49.6	-50.6	-0.697	-138
700	-0.241	-179	3.77	11.3	-50.7	-50.0	-0.633	-141
750	-0.250	-180	3.53	7.19	-51.5	-51.1	-0.593	-144
800	-0.287	179	3.36	2.91	-52.3	-48.2	-0.576	-146
850	-0.325	178	3.54	-1.78	-53.1	-50.9	-0.449	-148
900	-0.397	177	4.04	-7.86	-53.4	-52.3	-0.391	-150
950	-0.539	176	4.89	-15.7	-53.4	-56.9	-0.342	-152
1000	-0.839	174	6.06	-27.7	-52.4	-68.8	-0.247	-154
1050	-1.45	174	7.55	-47.7	-50.9	-97.0	-0.114	-156
1100	-1.98	180	8.01	-79.6	-49.6	-140	-0.232	-159
1150	-1.33	-175	5.76	-113	-49.5	175	-0.463	-160
1200	-0.689	-176	2.23	-134	-50.5	147	-0.527	-161
1250	-0.379	-177	-1.11	-146	-50.5	127	-0.535	-162
1300	-0.231	-178	-4.10	-155	-50.5	118	-0.552	-162
1350	-0.170	-179	-6.82	-159	-50.2	109	-0.463	-163
1400	-0.123	-180	-9.12	-164	-49.8	104	-0.470	-164
1450	-0.101	179	-11.2	-167	-49.3	101	-0.493	-164
1500	-0.072	179	-13.2	-170	-49.1	99.7	-0.466	-165

Test Circuit

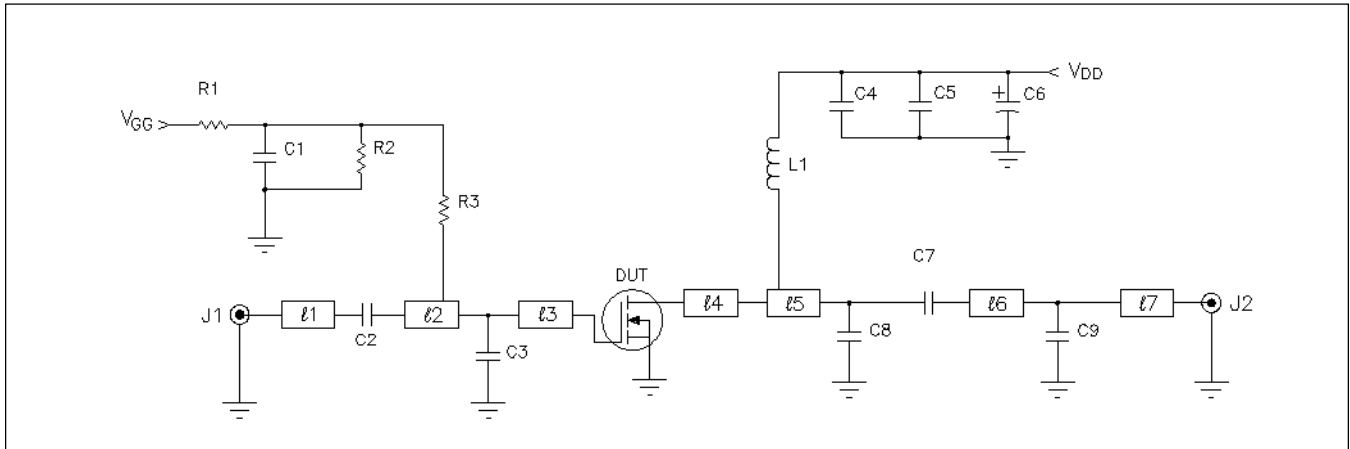

Test Circuit Schematic for $f = 960$ MHz

DUT	PTF 10193		C1, C2, C4, C7	Capacitor, 36 pF	100B 360
l1	0.1425 λ 960 MHz	Microstrip 50 Ω	C3	Capacitor, 5.1 pF	100A 5R1
l2	0.1309 λ 960 MHz	Microstrip 9.29 Ω	C5	Capacitor, 0.1 μ F, 50 V	DIGI-KEY P4525-ND
l3	0.1640 λ 960 MHz	Microstrip 9.29 Ω	C6	Capacitor, 100 μ F, 50 V	DIGI-KEY P5182-ND
l4	0.0174 λ 960 MHz	Microstrip 29.4 Ω	C8	Capacitor, 3.6 pF	100B 3R6
l5	0.1916 λ 960 MHz	Microstrip 11.72 Ω	C9	Capacitor, 2.7 pF	100B 2R7
l6	0.0535 λ 960 MHz	Microstrip 50 Ω	R1, R2, R3	Resistor, 220 Ω	DIGI-KEY 220QBK-ND
l7	0.0321 λ 960 MHz	Microstrip 50 Ω	L1	4 Turns, 20 AWG, .120 I.D./N/A	
			Circuit Board	G200, .031" Thick, 2 oz. Copper	
				$\epsilon_r = 4.00$, AlliedSignal	

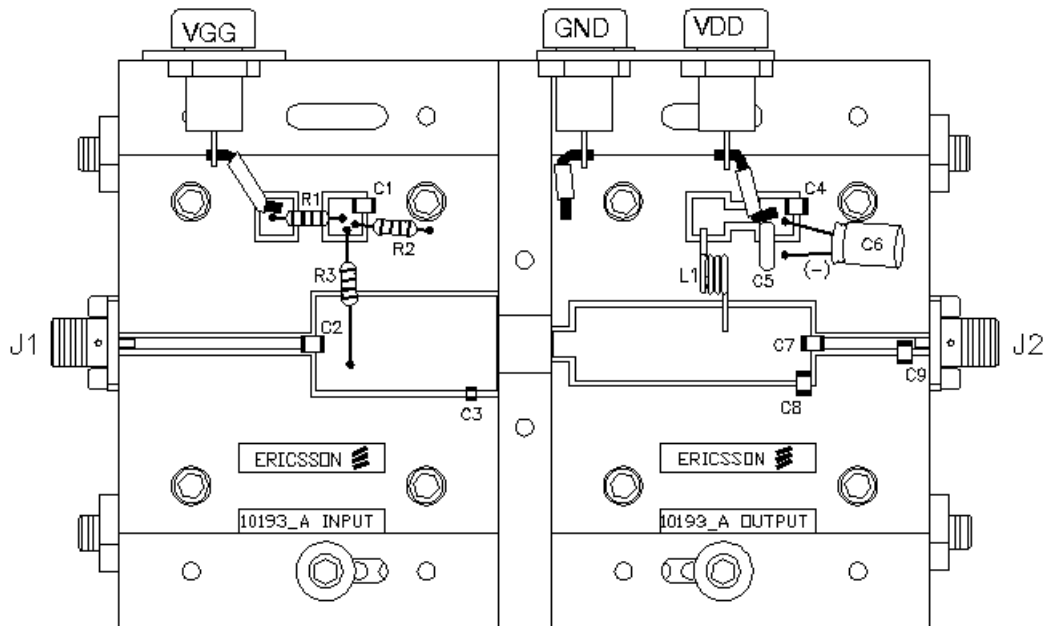

Assembly Diagram (not to scale)

Test Circuit

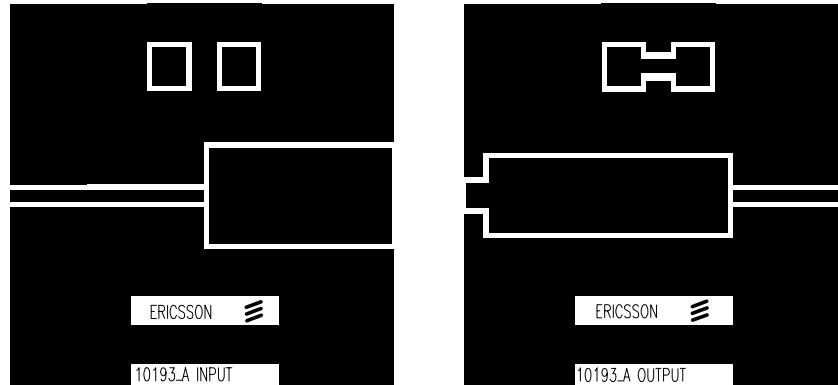

Artwork (not to scale)

Case Outline Specifications

