

PTB 20125

100 Watts, 1.8–2.0 GHz

PCN/PCS Power Transistor

Description

The 20125 is an NPN, push-pull RF power transistor intended for 26 Vdc class AB operation from 1.8 to 2.0 GHz. Rated at 100 watts PEP minimum output power, it is specifically intended for operation as a final stage in CDMA or TDMA systems. Ion implantation, nitride surface passivation and gold metallization ensure excellent device reliability. 100% lot traceability is standard.

- 100 Watts, 1.8–2.0 GHz
- Class AB Characteristics
- 40% Collector Efficiency at 100 Watts
- Gold Metallization
- Silicon Nitride Passivated

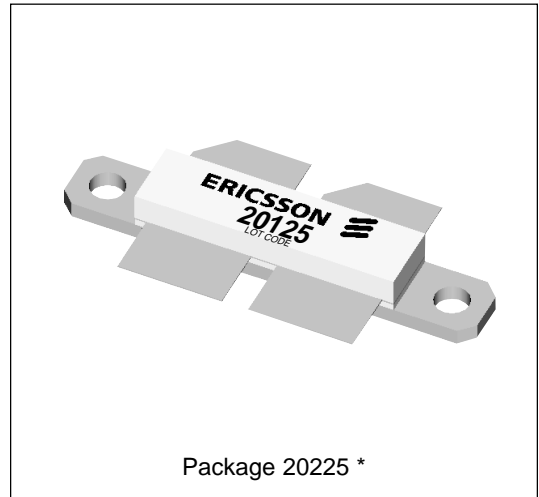
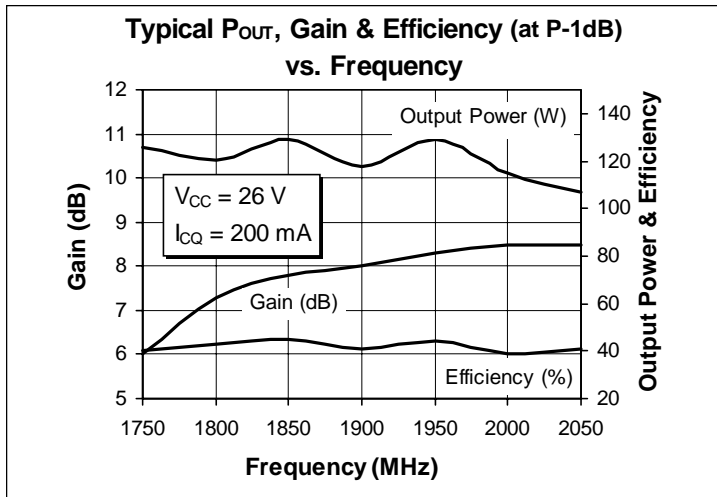

Maximum Ratings

Parameter	Symbol	Value	Unit
Collector-Emitter Voltage	V_{CER}	55	Vdc
Collector-Base Voltage	V_{CBO}	55	Vdc
Emitter-Base Voltage (collector open)	V_{EBO}	4.0	Vdc
Collector Current (continuous)	I_C	14	Adc
Total Device Dissipation at $T_{flange} = 25^{\circ}C$ Above $25^{\circ}C$ derate by	P_D	400 2.3	Watts W/ $^{\circ}C$
Storage Temperature Range	T_{STG}	-40 to +150	$^{\circ}C$
Thermal Resistance ($T_{flange} = 70^{\circ}C$)	$R_{\theta JC}$	0.44	$^{\circ}C/W$

* This product not recommended or specified for CW or class A operation. Recommend two PTB 20175 for these applications.

Electrical Characteristics (100% Tested)

Characteristic	Conditions	Symbol	Min	Typ	Max	Units
Breakdown Voltage C to E	$V_{BE} = 0\text{ V}$, $I_C = 100\text{ mA}$	$V_{(BR)CES}$	55	—	—	Volts
Breakdown Voltage E to B	$I_C = 0\text{ A}$, $I_E = 20\text{ mA}$	$V_{(BR)EBO}$	4.0	5.0	—	Volts
DC Current Gain	$V_{CE} = 10\text{ V}$, $I_C = 1.5\text{ A}$	h_{FE}	30	50	120	—

RF Specifications (100% Tested)

Characteristic	Symbol	Min	Typ	Max	Units
Gain ($V_{CC} = 26\text{ Vdc}$, $P_{out} = 40\text{ W(PEP)}$, $I_{CQ} = 2 \times 100\text{ mA}$, $f = 2\text{ GHz}$)	G_{pe}	7.0	8.0	—	dB
Collector Efficiency ($V_{CC} = 26\text{ Vdc}$, $P_{out} = 100\text{ W}$, $I_{CQ} = 2 \times 100\text{ mA}$, $f = 2\text{ GHz}$)	η_C	40	45	—	%
Load Mismatch Tolerance ($V_{CC} = 26\text{ Vdc}$, $P_{out} = 100\text{ W(PEP)}$, $I_{CQ} = 2 \times 100\text{ mA}$, $f = 2\text{ GHz}$ —at all phase angles)	Ψ	—	—	5:1	—

Typical Performance

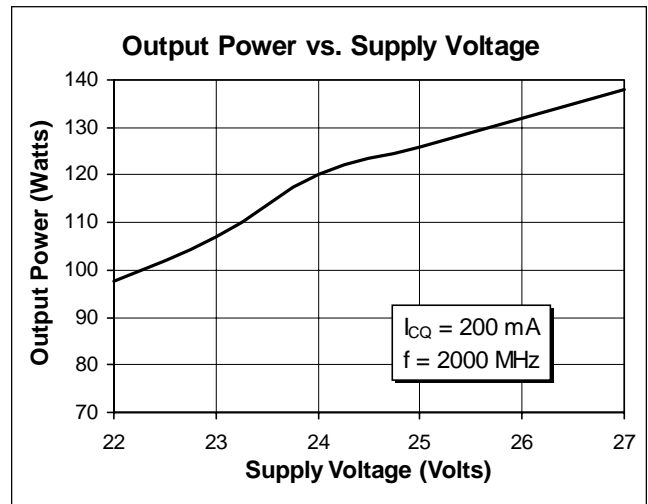
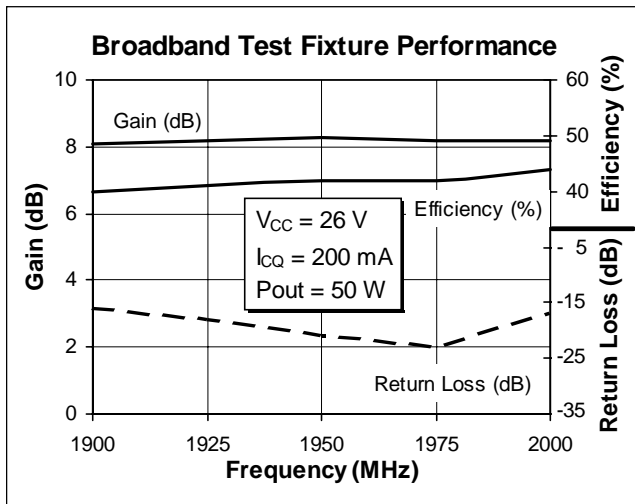

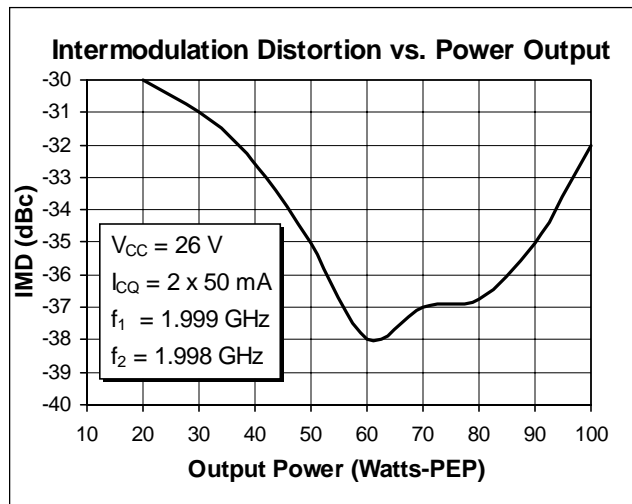
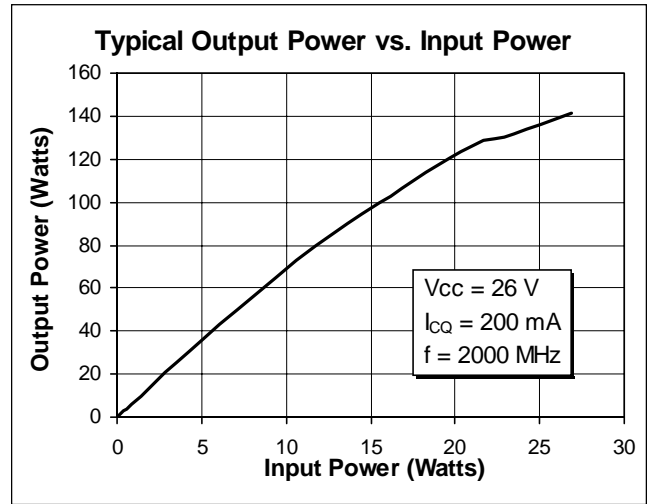
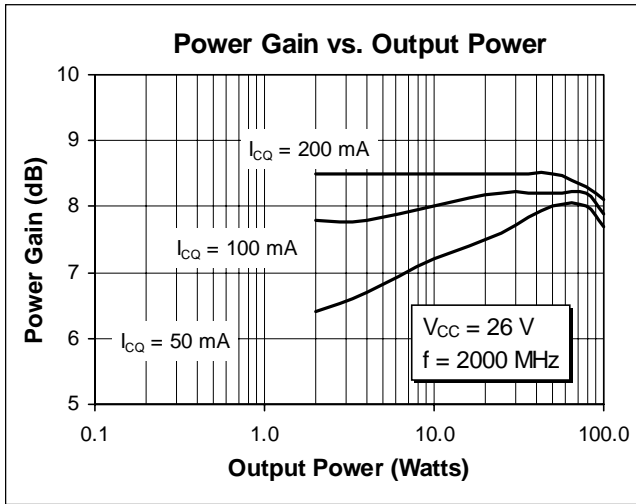

Impedance Data

($V_{CC} = 26$ Vdc, $P_{out} = 100$ W, $I_{CQ} = 2 \times 100$ mA)

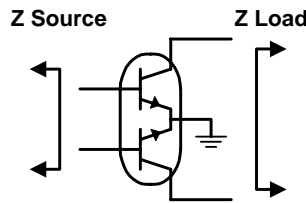

Frequency GHz	Z Source		Z Load	
	R	jX	R	jX
1.75	5.4	-6.2	5.1	-6.2
1.80	5.8	-7.6	5.2	-5.8
1.85	6.0	-8.6	5.4	-5.0
1.90	7.2	-9.2	5.6	-4.0
1.95	8.8	-9.0	5.8	-2.8
2.00	10.4	-7.2	6.0	-2.4
2.05	11.8	-2.4	6.2	-1.8

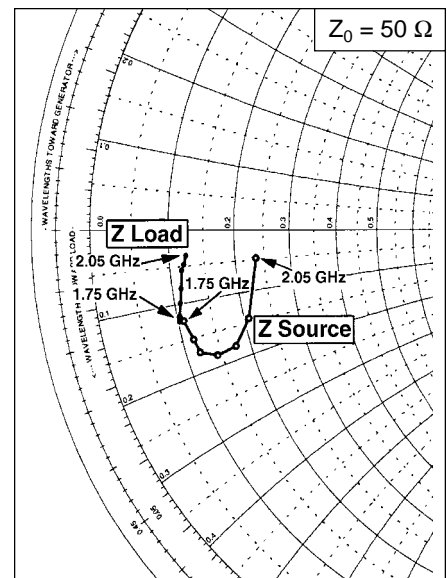

Test Circuit

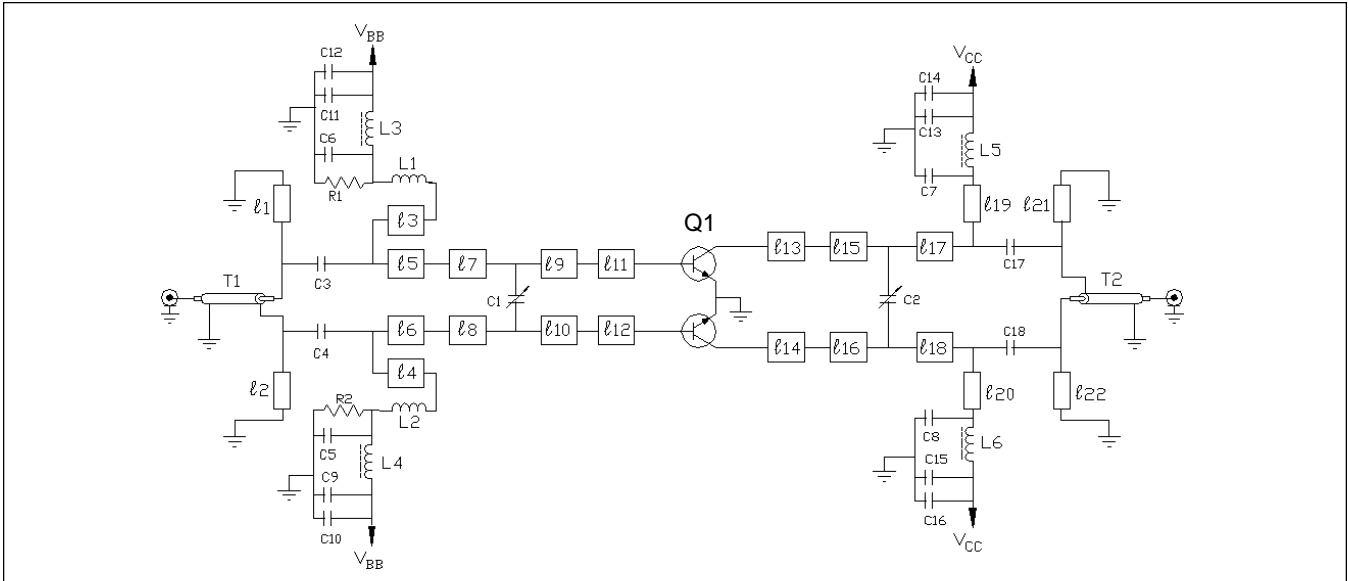

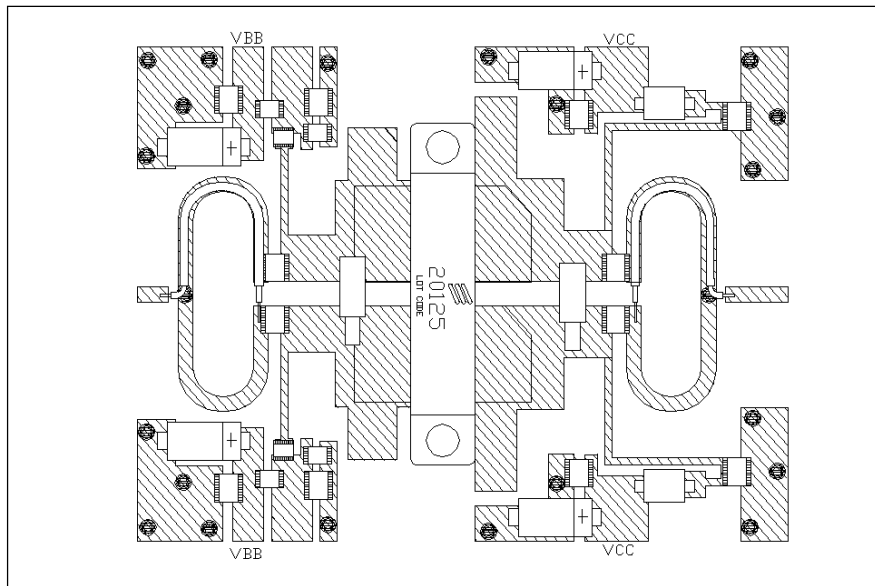

Block Diagram for $f = 2\text{ GHz}$

Q1	PTB 20125 NPN RF Transistor	L1, L2	6.8 nH SMT Inductor
l1, l2, l21, l22	.25λ 2GHz Microstrip 50 Ω	L3, L4	56 nH SMT Inductor
l3, l4	.085λ 2GHz Microstrip 80 Ω	L5, L6	4 mm. SMT Ferrite
l5, l6	.067λ 2GHz Microstrip 20 Ω	C1, C2	0–4 pF Johanson Piston Trimmer
l7, l8, l11, l12	.0217λ 2GHz Microstrip 11.7 Ω	C3-8, C17, C18	33 pF (B ATC 100)
l9, l10	.053λ 2GHz Microstrip 8.15 Ω	C9, C11, C13, C15	.1 μF 1206
l13, l14	.055λ 2GHz Microstrip 6.7 Ω	C10, C12, C14, C16	10 μF SMT Tantalum
l15, l16	.052λ 2GHz Microstrip 11.45 Ω	R1, R2	22 Ω SMT
l17, l18	.060λ 2GHz Microstrip 16.9 Ω	T1, T2	UT 70-50
l19, l20	.252λ 2GHz Microstrip 75 Ω	Board	0.031: G200, Solid Copper Bottom, AlliedSignal

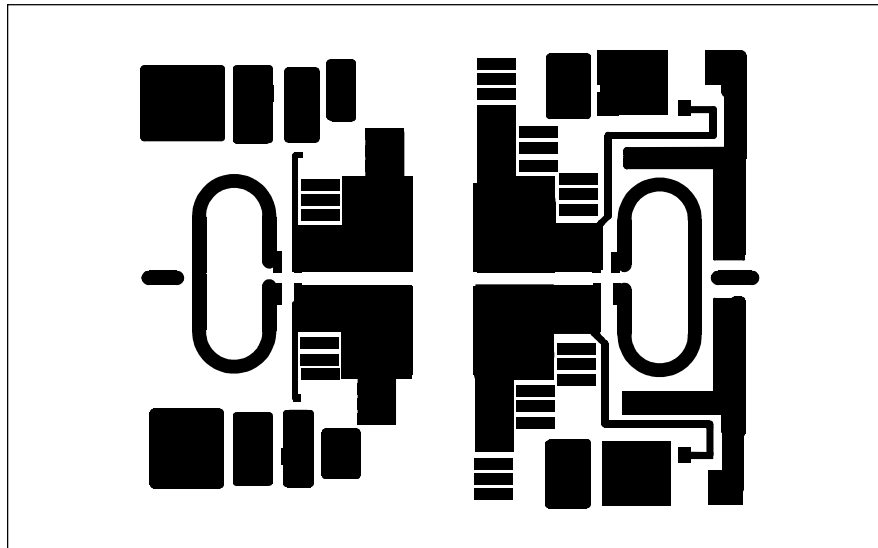

Placement Diagram (not to scale)



Artwork (1 inch )