

# PTB 20151

## 45 Watts, 1.8–2.0 GHz

### PCN/PCS Power Transistor

#### Description

The 20151 is a class AB, NPN common emitter RF power transistor intended for 26 Vdc operation from 1.8 to 2.0 GHz. Rated at 45 watts minimum output power for PEP applications, it is specifically intended for operation as a final or driver stage in CDMA or TDMA systems. Ion implantation, nitride surface passivation and gold metallization ensure excellent device reliability. 100% lot traceability is standard.

- 45 Watts, 1.8–2.0 GHz
- Class AB Characteristics
- 40% Collector Efficiency at 45 W
- Gold Metallization
- Silicon Nitride Passivated

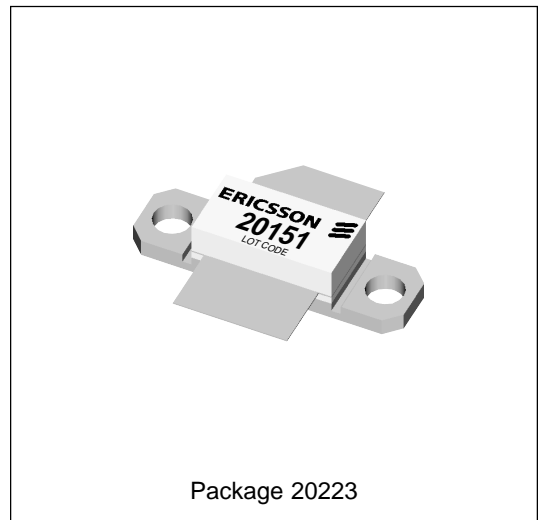
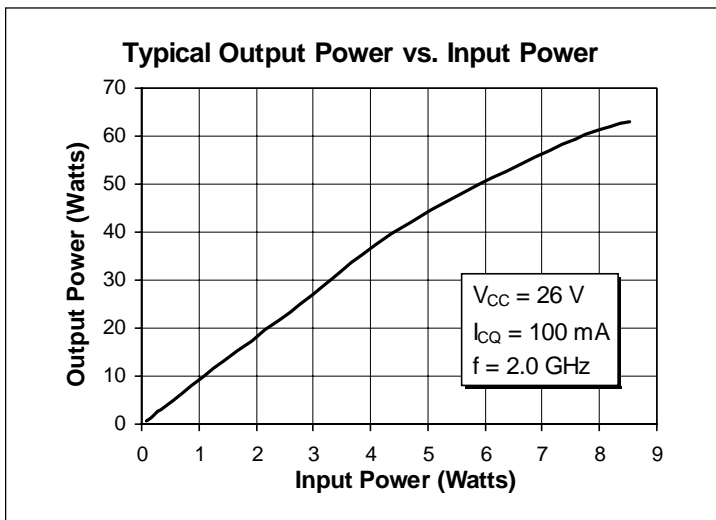

#### Maximum Ratings

Parameter	Symbol	Value	Unit
Collector-Emitter Voltage	$V_{CER}$	50	Vdc
Collector-Base Voltage	$V_{CBO}$	50	Vdc
Emitter-Base Voltage (collector open)	$V_{EBO}$	4.0	Vdc
Collector Current (continuous)	$I_C$	7.7	Adc
Total Device Dissipation at $T_{flange} = 25^\circ C$ Above $25^\circ C$ derate by	$P_D$	200 1.2	Watts W/ $^\circ C$
Storage Temperature Range	$T_{STG}$	-40 to +150	$^\circ C$
Thermal Resistance ( $T_{flange} = 70^\circ C$ )	$R_{\theta JC}$	0.85	$^\circ C/W$

## Electrical Characteristics (100% Tested)

Characteristic	Conditions	Symbol	Min	Typ	Max	Units
Breakdown Voltage C to E	$V_{BE} = 0\text{ V}, I_C = 100\text{ mA}$	$V_{(BR)CES}$	50	—	—	Volts
Breakdown Voltage C to E	$I_B = 0\text{ A}, I_C = 100\text{ mA}, R_{BE} = 22\ \Omega$	$V_{(BR)CER}$	50	—	—	Volts
Breakdown Voltage E to B	$I_C = 0\text{ A}, I_E = 5\text{ mA}$	$V_{(BR)EBO}$	4.0	5.0	—	Volts
DC Current Gain	$V_{CE} = 5\text{ V}, I_C = 1\text{ A}$	$h_{FE}$	20	40	—	—

## RF Specifications (100% Tested)

Characteristic	Symbol	Min	Typ	Max	Units
<b>Gain</b> ( $V_{CC} = 26\text{ Vdc}, P_{OUT} = 10\text{ W}, I_{CQ} = 100\text{ mA}, f = 2\text{ GHz}$ )	$G_{pe}$	8.0	9.5	—	dB
<b>Power Output at 1 dB Compression</b> ( $V_{CC} = 26\text{ Vdc}, P_{OUT} = 45\text{ W}, I_{CQ} = 100\text{ mA}, f = 2\text{ GHz}$ )	P-1dB	45.0	—	—	Watts
<b>Collector Efficiency</b> ( $V_{CC} = 26\text{ Vdc}, P_{OUT} = 45\text{ W}, I_{CQ} = 100\text{ mA}, f = 2\text{ GHz}$ )	$\eta_C$	40	47	—	%
<b>Load Mismatch Tolerance</b> ( $V_{CC} = 26\text{ Vdc}, P_{OUT} = 22.5\text{ W}, I_{CQ} = 100\text{ mA}, f = 2\text{ GHz}$ —all phase angles at frequency of test)	$\Psi$	—	—	5:1	—

## Typical Performance

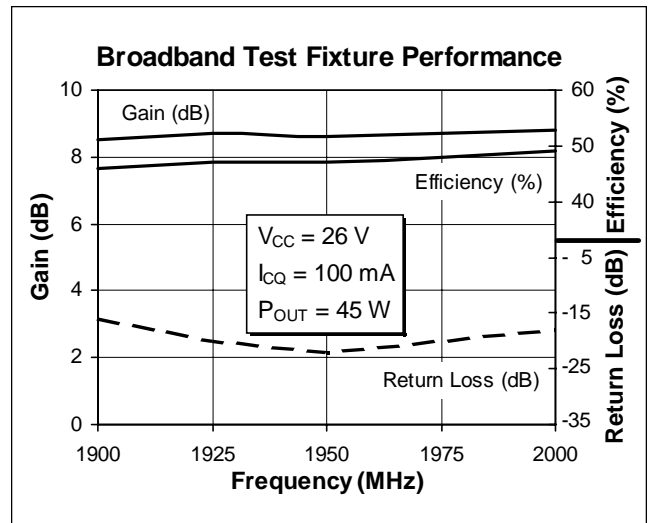
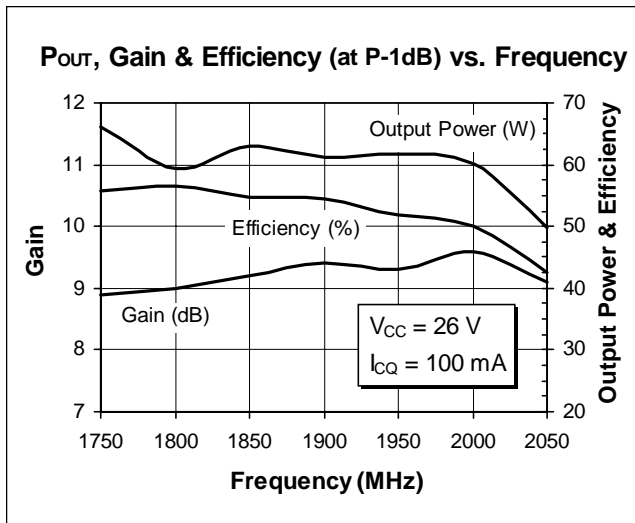

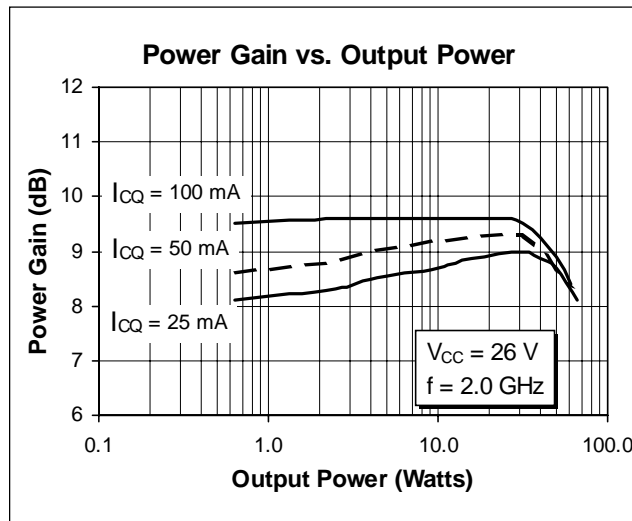
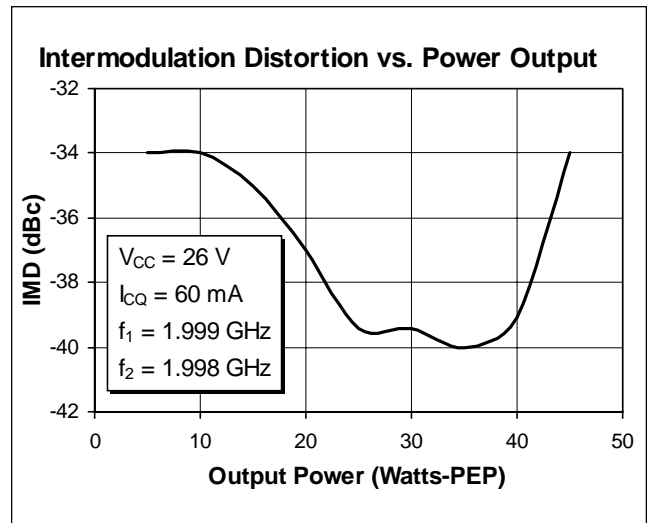
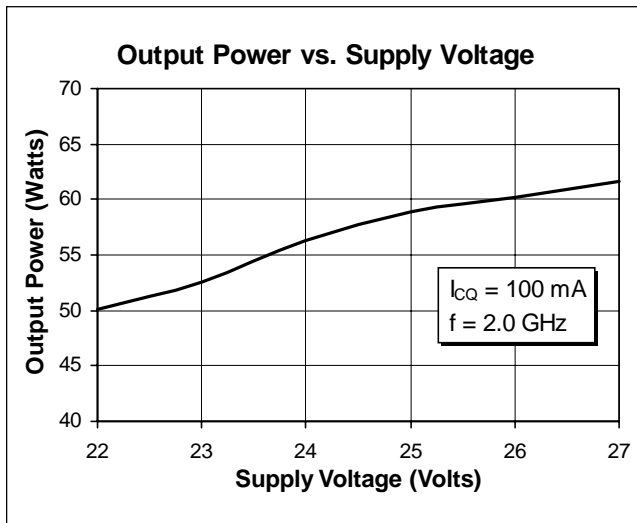

**Impedance Data**

( $V_{CC} = 26 \text{ Vdc}$ ,  $P_{OUT} = 45 \text{ W}$ ,  $I_{CQ} = 100 \text{ mA}$ )

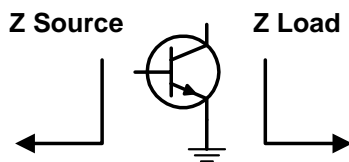

Frequency GHz	Z Source		Z Load	
	R	jX	R	jX
1.75	3.15	-1.7	3.3	-0.8
1.80	3.10	-2.7	4.1	-1.2
1.85	3.50	-3.1	4.3	-1.5
1.90	3.70	-2.9	3.3	-1.3
1.95	3.90	-2.7	2.6	-1.1
2.00	4.10	-2.1	2.4	-0.9
2.05	3.75	-1.0	2.3	-0.7

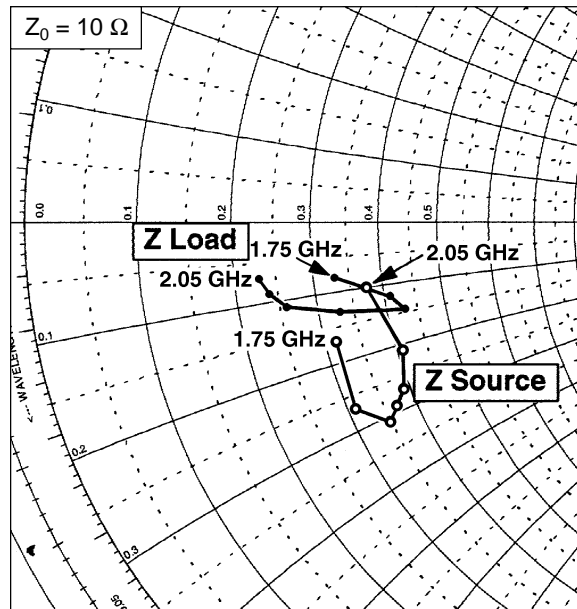

Test Circuit

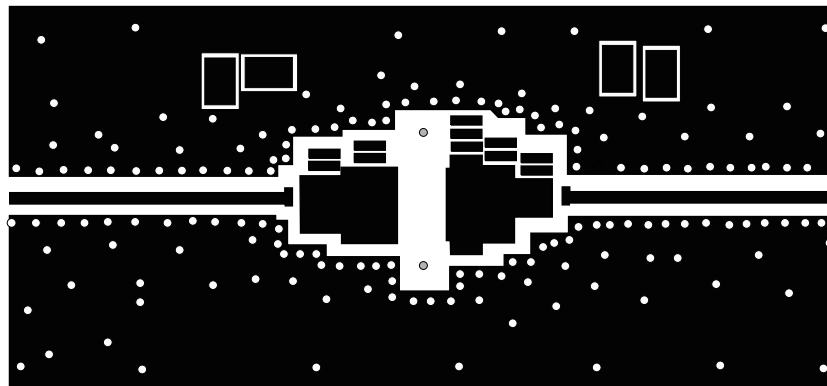

Artwork (1 inch )

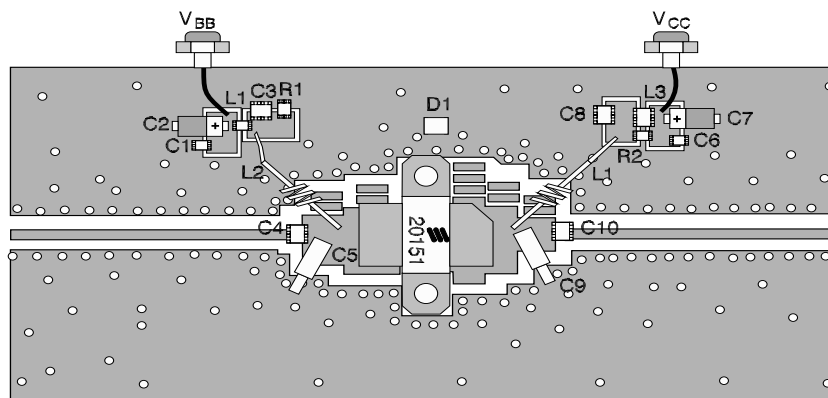

Parts Layout (not to scale)

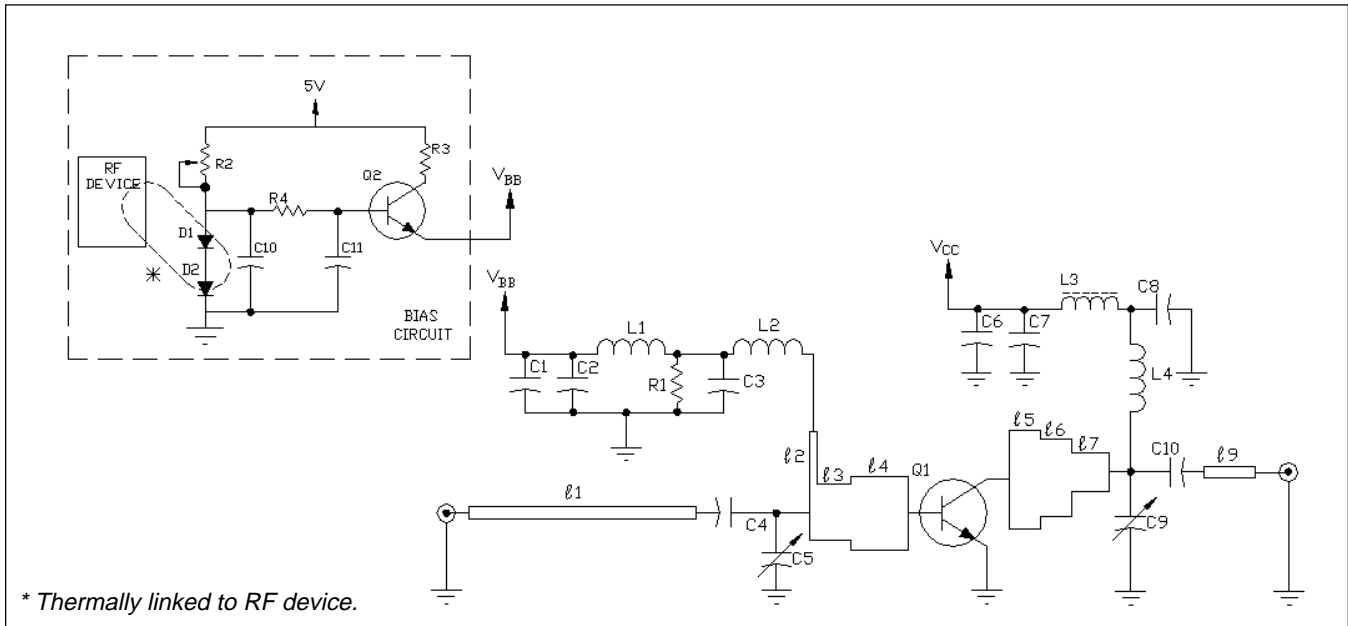

Schematic for  $f = 2 \text{ GHz}$

Q1	PTB 20151	NPN RF Transistor	L1	56 nh	SMT Inductor
$\ell 1, \ell 9$		Microstrip 50 $\Omega$	L2, L4	3 Turn #22, 0.25" O.D.	
$\ell 2$	.1 $\lambda$ 2 GHz	Microstrip 75 $\Omega$	L3	4 mm.	SMT Ferrite
$\ell 3$	.065 $\lambda$ 2 GHz	Microstrip 16 $\Omega$	R1	22 $\Omega$	1206 SMT Resistor
$\ell 4$	.095 $\lambda$ 2 GHz	Microstrip 12.5 $\Omega$	Board	0.031 G-200 Solid Copper Bottom, AlliedSignal	
$\ell 5$	.055 $\lambda$ 2 GHz	Microstrip 9.7 $\Omega$	<i>Bias Parts (not shown on layout)</i>		
$\ell 6$	.055 $\lambda$ 2 GHz	Microstrip 12.5 $\Omega$	Q2	BCP 56	SMT NPN Transistor
$\ell 7$	.065 $\lambda$ 2 GHz	Microstrip 22 $\Omega$	D1	BAV 99	Diode
C1, C6	0.1 $\mu\text{F}$	1206 Chip	C10, C11	0.1 pF	SMT Capacitor
C2, C7	10 $\mu\text{F}$ , 35 V	SMT Tantalum	R2	2K	Potentiometer
C3, C4, C8, C10	20 pF	ATC-100	R3, R4	10 $\Omega$	1206 SMT Resistor
C5, C9	0-4 pf	Johanson Trimmer			