

PTB 20175

55 Watts, 1.9–2.0 GHz

Cellular Radio RF Power Transistor

Description

The 20175 is a class AB, NPN common emitter RF power transistor intended for 26 Vdc operation from 1.9 to 2.0 GHz. It is rated at 55 watts minimum output power and may be used for both CW and PEP applications. Ion implantation, nitride surface passivation and gold metallization are used to ensure excellent device reliability. 100% lot traceability is standard.

- 55 Watts, 1.9–2.0 GHz
- Class AB Characteristics
- 40% Collector Efficiency at 55 Watts
- Gold Metallization
- Silicon Nitride Passivated

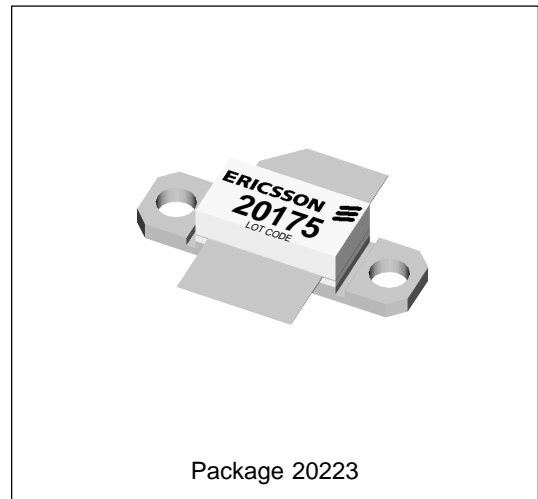
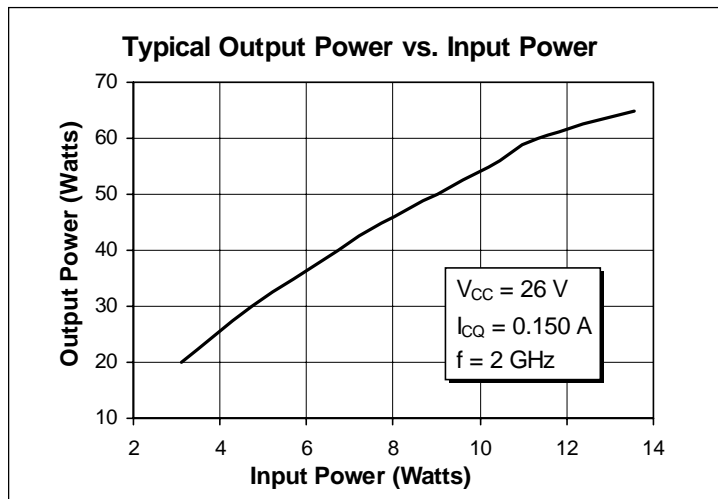

Maximum Ratings

Parameter	Symbol	Value	Unit
Collector-Emitter Voltage	V_{CER}	55	Vdc
Collector-Emitter Voltage	V_{CES}	55	Vdc
Emitter-Base Voltage (collector open)	V_{EBO}	4	Vdc
Collector Current (continuous)	I_C	8	Adc
Total Device Dissipation at $T_{flange} = 25^\circ C$ Above $25^\circ C$ derate by	P_D	233 1.33	W W/ $^\circ C$
Storage Temperature Range	T_{stg}	-40 to +150	$^\circ C$
Thermal Resistance ($T_{flange} = 70^\circ C$)	$R_{\theta JC}$.75	$^\circ C/W$

Electrical Characteristics (100% Tested)

Characteristics	Conditions	Symbol	Min	Typ	Max	Units
Breakdown Voltage C to E	$I_C = 60 \text{ mA}$, $R_B = 27 \Omega$	$V_{(BR)CER}$	55	—	—	Volts
Breakdown Voltage C to E	$V_{BE} = 0 \text{ V}$, $I_C = 60 \text{ mA}$	$V_{(BR)CES}$	55	—	—	Volts
Breakdown Voltage E to B	$I_C = 0 \text{ V}$, $I_E = 25 \text{ mA}$	$V_{(BR)EBO}$	4.0	5	—	Volts
DC Current Gain	$V_{CE} = 5 \text{ V}$, $I_C = 300 \text{ mA}$	H_{fe}	—	50	—	—

RF Specifications (100% Tested)

Characteristics	Symbol	Min	Typ	Max	Units
Gain ($V_{CC} = 26 \text{ Vdc}$, $P_{out} = 55 \text{ W}$, $I_{CQ} = 150 \text{ mA}$, $f = 2.0 \text{ GHz}$)	G_{pe}	7.0	7.6	—	dB
Collector Efficiency ($V_{CC} = 26 \text{ Vdc}$, $P_{out} = 55 \text{ W}$, $I_{CQ} = 150 \text{ mA}$, $f = 2.0 \text{ GHz}$)	η_C	37	47	—	%
Load Mismatch Tolerance ($V_{CC} = 26 \text{ Vdc}$, $P_{out} = 55 \text{ W(PEP)}$, $I_{CQ} = 150 \text{ mA}$, $f = 2.0 \text{ GHz}$ —All Phase Angles at Frequency of Test)	Ψ	—	—	5:1	—

Impedance Data (data shown for fixed-tuned broadband circuit)

($V_{CC} = 26 \text{ Vdc}$, $P_{out} = 55 \text{ W}$, $I_{CQ} = 150 \text{ mA}$)

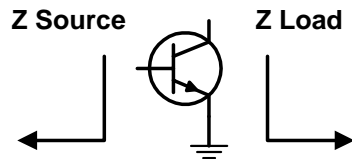

Frequency	Z Source		Z Load	
	R	jX	R	jX
1.90	3.26	-2.0	2.30	-1.9
1.95	3.26	-1.7	2.25	-2.2
2.00	3.26	-1.4	2.20	-2.5

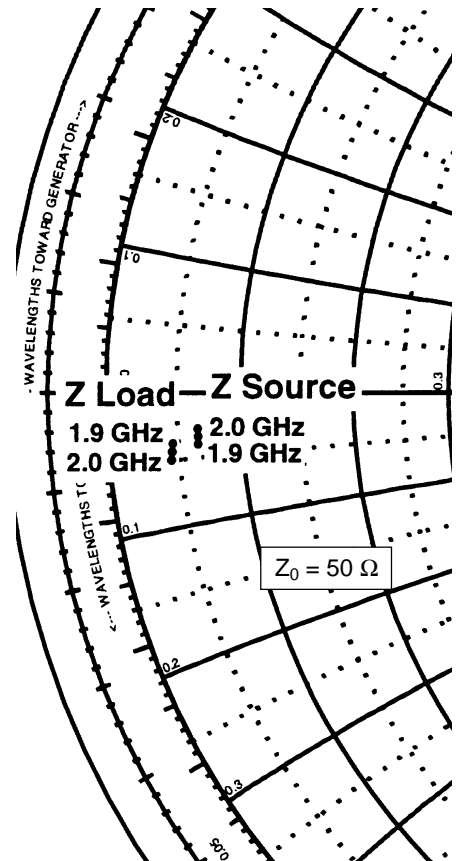

Typical Performance

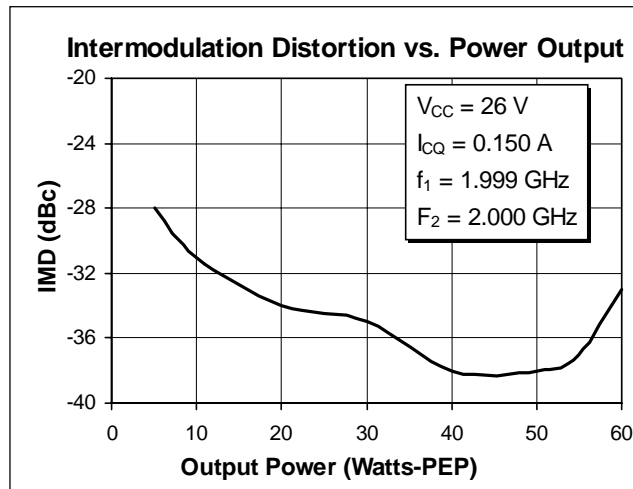
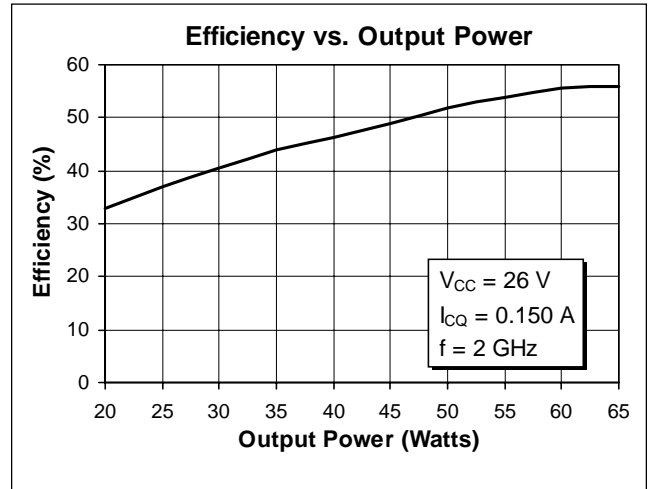
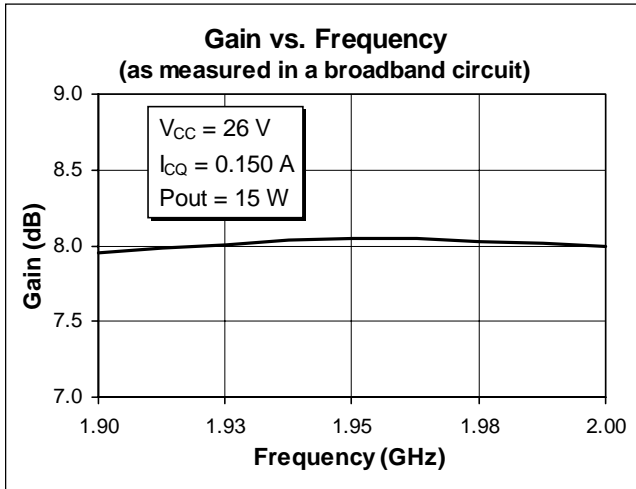

Test Circuit

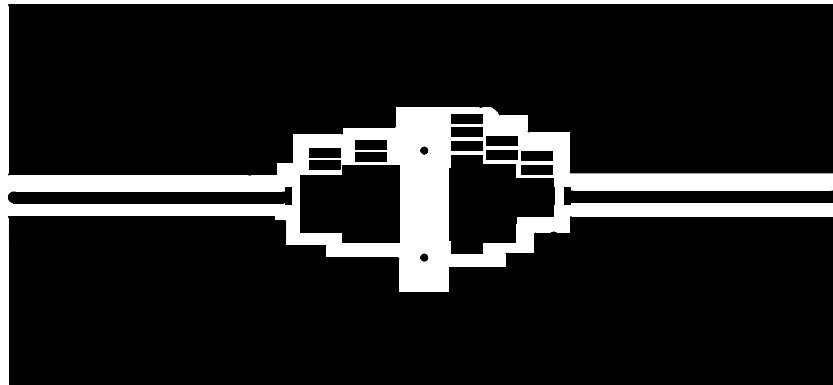

Artwork (1 inch )

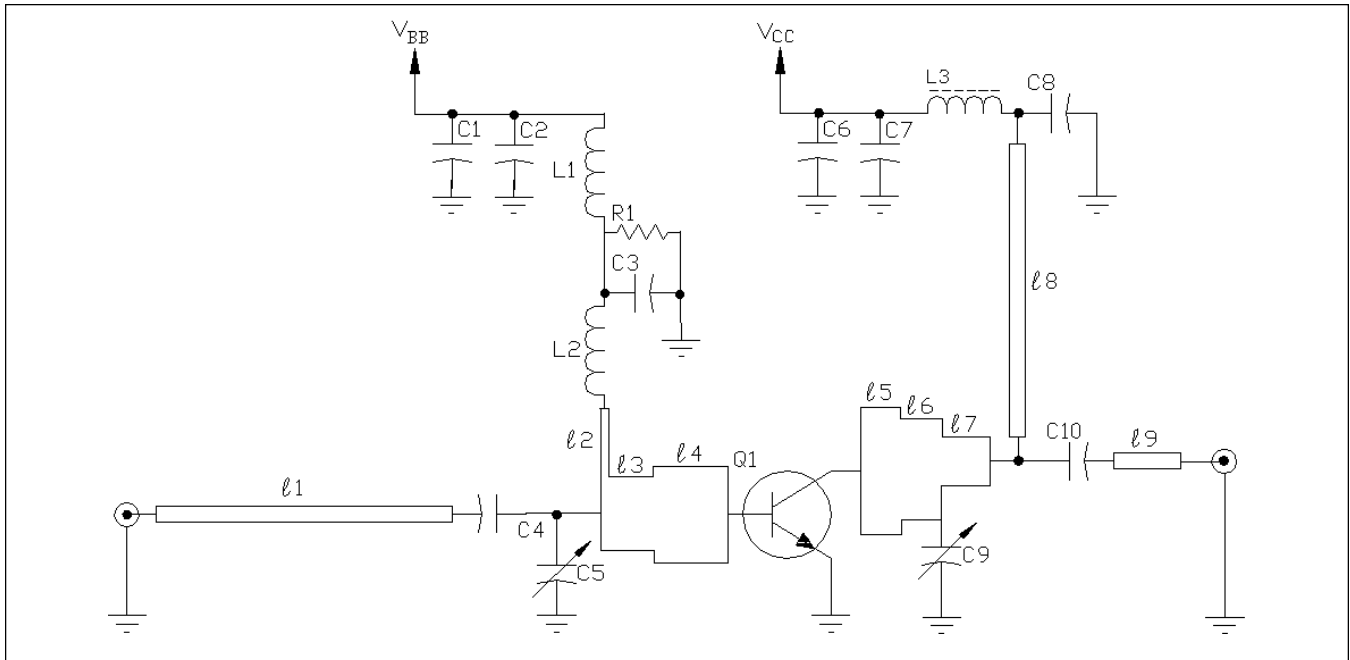

Schematic for $f = 2 \text{ GHz}$

Q1	PTB 20175	NPN RF Transistor	C1, C6	.1 μF	1206 Chip
l1		Microstrip 50 Ω	C2, C7	10 μF , 35 V	SMT Tantalum
l2	.1 λ 2 GHz	Microstrip 75 Ω	C3, C4, C8, C10	33 pF	ATC-100
l3	.065 λ 2 GHz	Microstrip 16 Ω	C5, C9	0 - 4 pf	Johanson Trimmer
l4	.095 λ 2 GHz	Microstrip 10.8 Ω	L1	56 nh	SMT Inductor
l5	.055 λ 2 GHz	Microstrip 8.0 Ω	L2	6.8 nh	SMT Inductor
l6	.055 λ 2 GHz	Microstrip 12.5 Ω	L3	4 mm.	SMT Ferrite
l7	.065 λ 2 GHz	Microstrip 22 Ω	R1	22 Ω	1206 Chip
l8	.25 λ 2 GHz	Microstrip 60 Ω	Board	.031 G-200 Solid Copper Bottom	
l9		Microstrip 50 Ω			