

PTH 31002

30 Watts, 1.9–2.0 GHz

50-Ohm Power Hybrid

Description

The PTH 31002 is a 50-ohm power hybrid intended for applications requiring linear power amplification in the PCS frequency range. The part is designed to operate with 50-ohm source and load impedances and includes bias circuitry with temperature compensation. The design is intended to simplify system design and save space with an overall size of less than one square inch.

- **Guaranteed Performance at 1.93 to 1.99 GHz, 28 V**
 - Output Power = 30 Watts (P-1dB) Min
 - Power Gain = 12 dB Min
 - Efficiency = 30% Min @ P-1dB
- **Rugged Hybrid Design**
- **High Single Stage Gain**
- **Excellent Linearity**
- **Input VSWR less than 1.5:1**
- **Full Gold Metallization**
- **100% Lot Traceability**

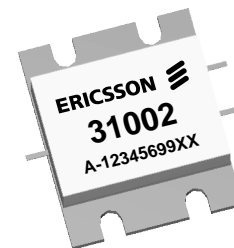
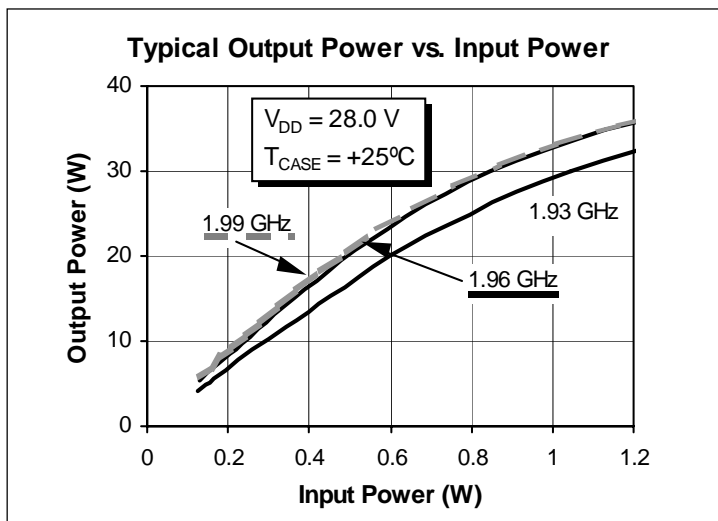

Package A

Performance Characteristics

Parameter	Symbol	Min	Typ	Max	Units
<i>V_{DD} = 28.0 V, I_{DQ} (Typical) = 550 mA</i>					
Frequency Range	f	1930	—	1990	MHz
Power Gain	G _p	12	14	—	dB
Output Power at 1 dB Compressed	P-1dB	30	34	—	W
Input VSWR	ψ	—	1.25:1	1.5:1	—
Efficiency at P-1dB	η	30	35	—	%

All published data at T_{CASE} = 25°C unless otherwise indicated.

Maximum Ratings

Parameter	Symbol	Value	Unit
Supply Voltage	V_{DD}	32	Vdc
Bias Current	I_{DQ}	1000	mA
Operating Current	—	4.5	A
Operating Temperature	T_{CASE}	90	°C
Total Device Dissipation at $T_{CASE} = 25^{\circ}C$ Above $25^{\circ}C$ derate by	P_D	TBD	Watts W/°C
Storage Temperature	T_{STG}	125	°C

Typical Performance

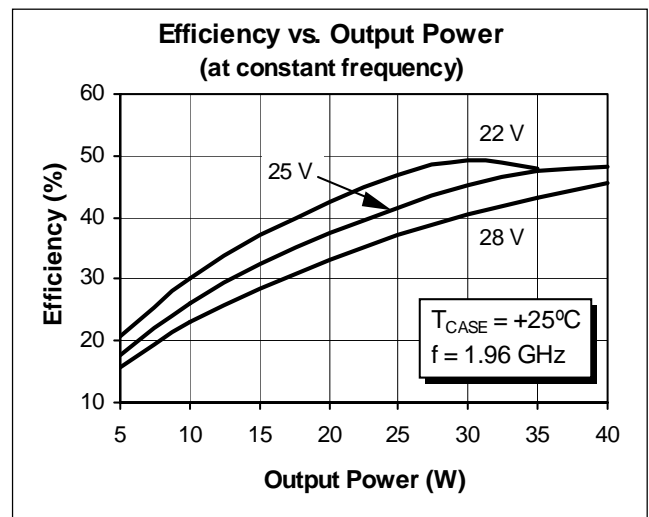
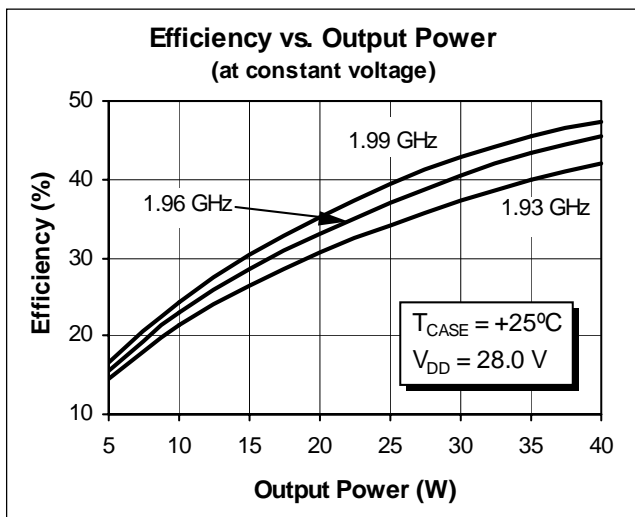
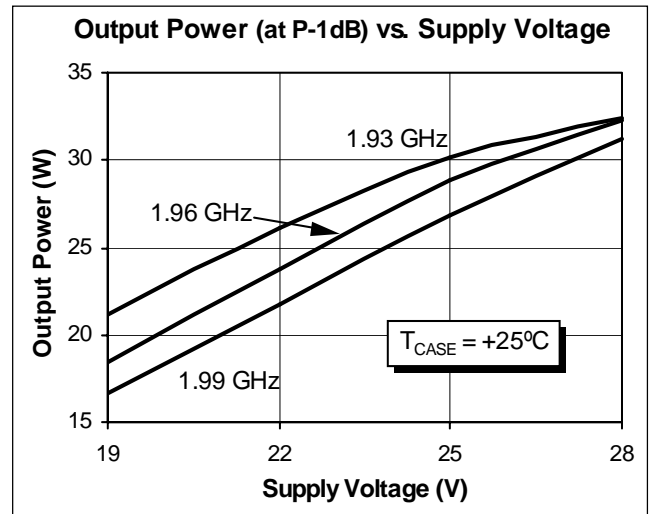
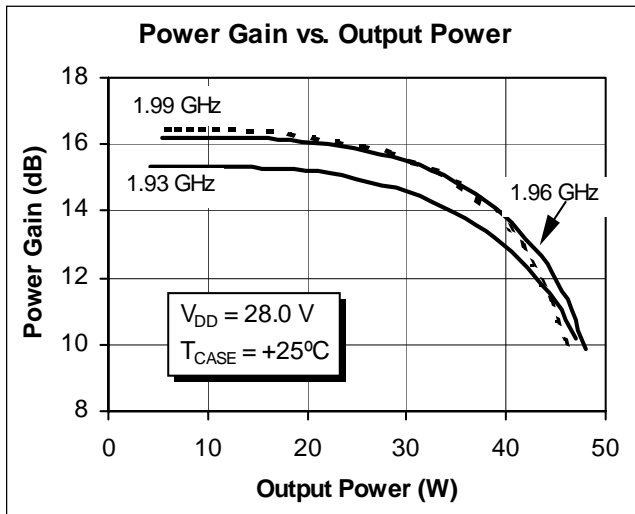

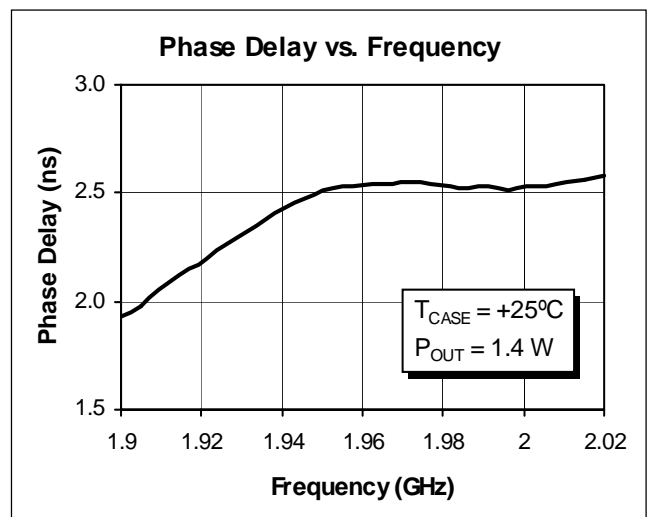
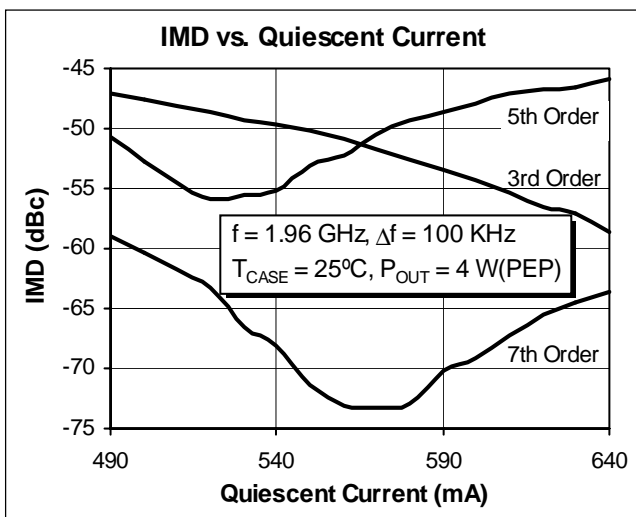
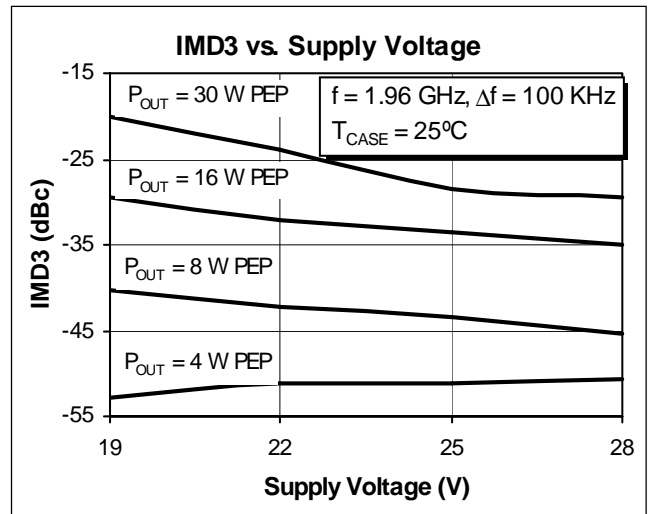
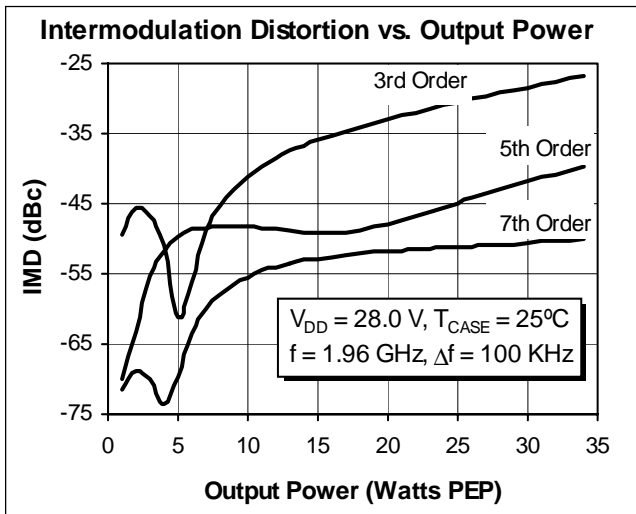
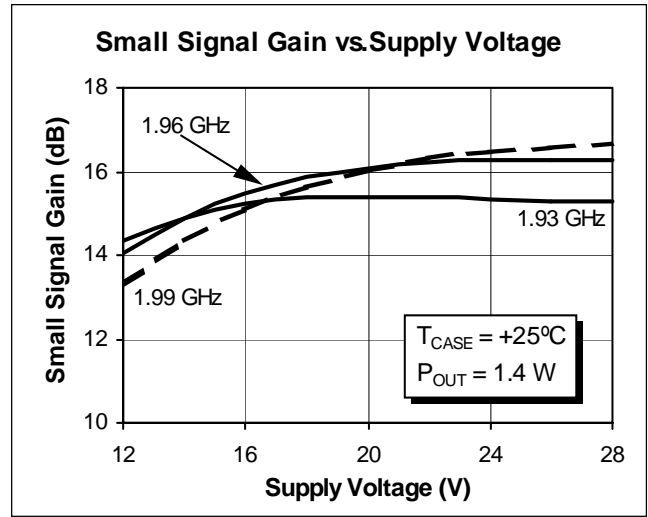
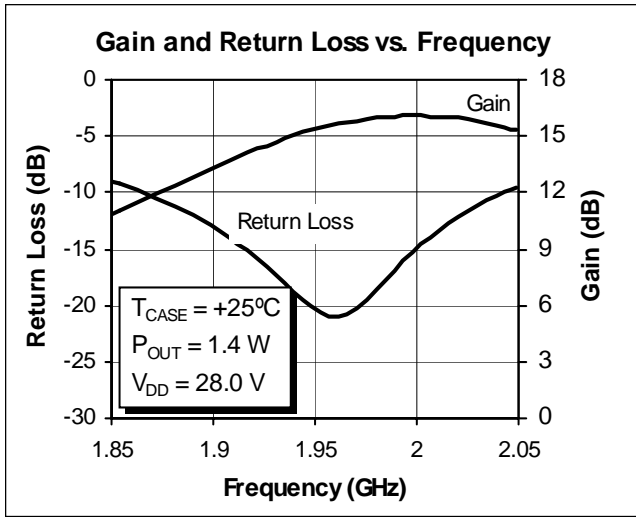

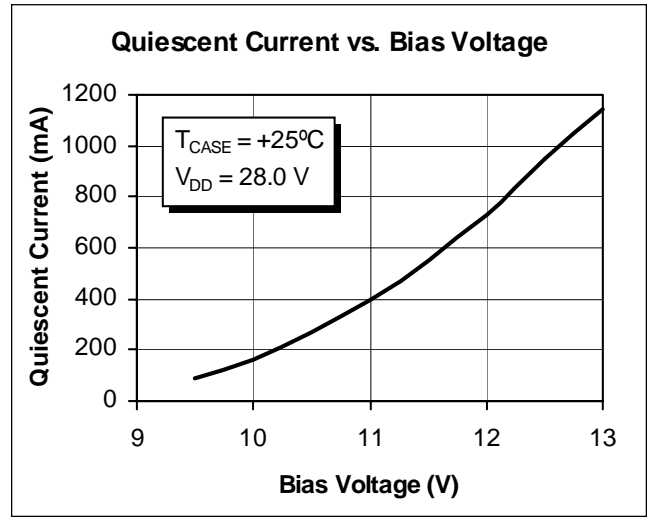
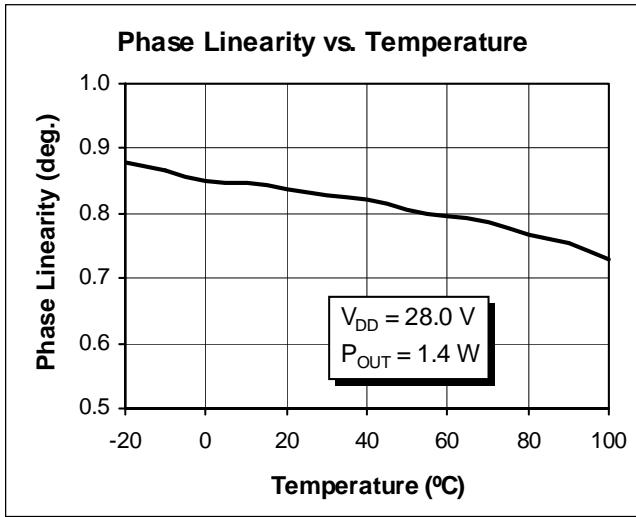

Schematic

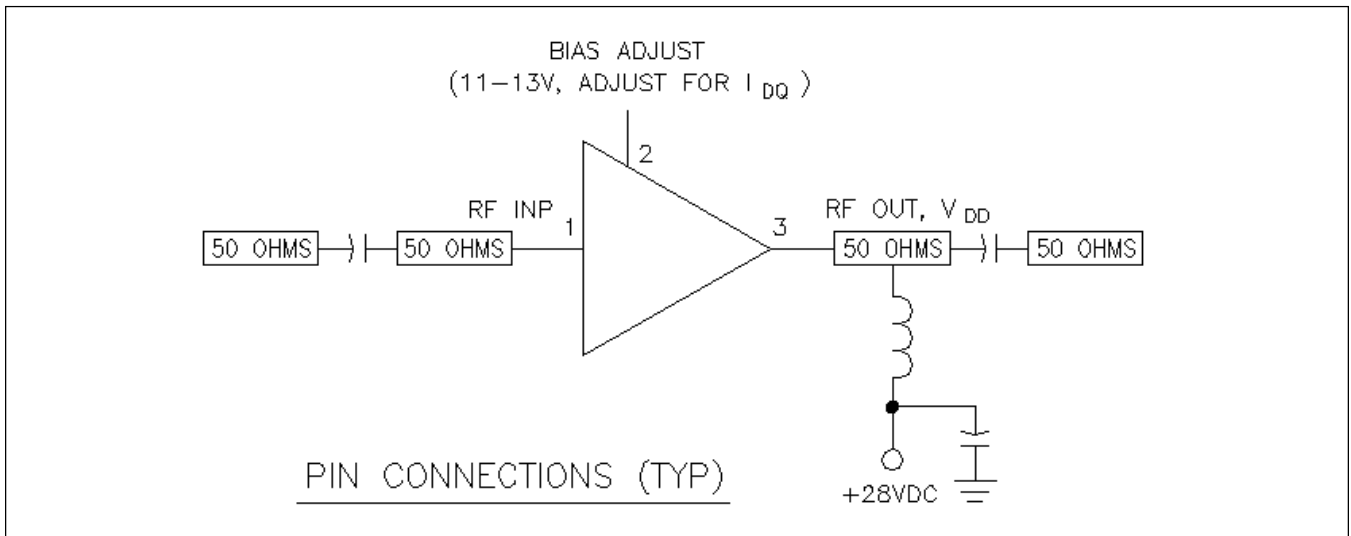

Case Outline Specifications

