

LOGIC LEVEL TRIAC

<p>TO220-AB</p>	<p>On-State Current 12 Amp</p> <p>Gate Trigger Current < 10 mA</p> <p>Off-State Voltage 200 V ÷ 600 V</p>
<p>This series of TRIACs uses a high performance PNP technology.</p> <p>These parts are intended for general purpose AC switching applications with highly inductive loads.</p>	

Absolute Maximum Ratings, according to IEC publication No. 134

SYMBOL	PARAMETER	CONDITIONS	Min.	Max.	Unit
$I_{T(RMS)}$	RMS On-state Current	Full sine wave, $T_C = 105^\circ\text{C}$	12		A
I_{TSM}	Non-repetitive On-State Current	Full Cycle, 60 Hz $t = 16.7\text{ ms}$	125		A
I_{TSM}	Non-repetitive On-State Current	Full Cycle, 50 Hz $t = 20\text{ ms}$	120		A
I^2t	Fusing Current	$t_p = 10\text{ ms}$, Half Cycle	80		A ² s
I_{GM}	Peak Gate Current	20 μs max. $T_j = 125^\circ\text{C}$		4	A
$P_{G(AV)}$	Average Gate Power Dissipation	$T_j = 125^\circ\text{C}$		1	W
di/dt	Critical rate of rise of on-state current	$I_G = 2 \times I_{GT}$, $t_r = 100\text{ ns}$ $f = 120\text{ Hz}$, $T_j = 125^\circ\text{C}$	50		A/ μs
T_j	Operating Temperature		-40	+125	$^\circ\text{C}$
T_{stg}	Storage Temperature		-40	+150	$^\circ\text{C}$

SYMBOL	PARAMETER	VOLTAGE			Unit
		B	D	M	
V_{DRM}	Repetitive Peak Off State Voltage	200	400	600	V
V_{RRM}					

LOGIC LEVEL TRIAC

Electrical Characteristics

SYMBOL	PARAMETER	CONDITIONS	Quadrant		SENSITIVITY		Unit
						08	
$I_{CT}^{(1)}$	Gate Trigger Current	$V_D = 12 V_{DC}, R_L = 30 \Omega, T_j = 25^\circ C$	Q1÷Q3	MAX		10	mA
I_{DRM} / I_{RRM}	Off-State Leakage Current	$V_D = V_{DRM}, R_{GK} = 1K, T_j = 125^\circ C$		MAX		1	mA
		$V_R = V_{RRM}, T_j = 25^\circ C$		MAX		5	μA
$V_{to}^{(2)}$	Threshold Voltage	$T_j = 125^\circ C$		MAX		0.85	V
$R_d^{(2)}$	Dynamic Resistance	$T_j = 125^\circ C$		MAX		35	m
$V_{TM}^{(2)}$	On-state Voltage	$I_T = 17 \text{ Amp}, t_p = 380 \mu s, T_j = 25^\circ C$		MAX		1.55	V
V_{GT}	Gate Trigger Voltage	$V_D = 12 V_{DC}, R_L = 30 \Omega, T_j = 25^\circ C$	Q1÷Q3	MAX		1.3	V
V_{GD}	Gate Non Trigger Voltage	$V_D = V_{DRM}, R_L = 3.3K, T_j = 125^\circ C$	Q1÷Q3	MIN		0.2	V
$I_H^{(2)}$	Holding Current	$I_T = 100 \text{ mA}, \text{ Gate open}, T_j = 25^\circ C$		MAX		15	mA
I_L	Latching Current	$I_G = 1.2 I_{CT}, T_j = 25^\circ C$	Q1,Q3	MAX		25	mA
			Q2	MAX		30	
$dv / dt^{(2)}$	Critical Rate of Voltage Rise	$V_D = 0.67 \times V_{DRM}, \text{ Gate open}$ $T_j = 125^\circ C$		MIN		40	V/ μs
$(dI/dt)_c^{(2)}$	Critical Rate of Current Rise	$(dv/dt)_c = 0.1 \text{ V}/\mu s, T_j = 125^\circ C$		MIN		6.5	A/ms
		$(dv/dt)_c = 10 \text{ V}/\mu s, T_j = 125^\circ C$		MIN		2.9	
		without snubber, $T_j = 125^\circ C$		MIN		-	
$R_{th(j-c)}$	Thermal Resistance Junction-Case	for AC 360° conduction angle				1.4	$^\circ C/W$
$R_{th(j-a)}$	Thermal Resistance Junction-Ambient					60	$^\circ C/W$

(1) Minimum I_{CT} is guaranteed at 5% of I_{CT} max.

(2) For either polarity of electrode MT2 voltage with reference to electrode MT1.

PART NUMBER INFORMATION

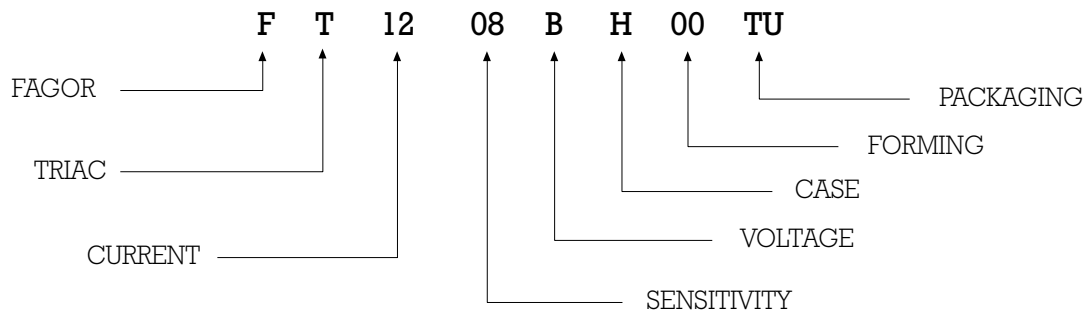

LOGIC LEVEL TRIAC

Fig. 1: Maximum power dissipation versus RMS on-state current (full cycle).

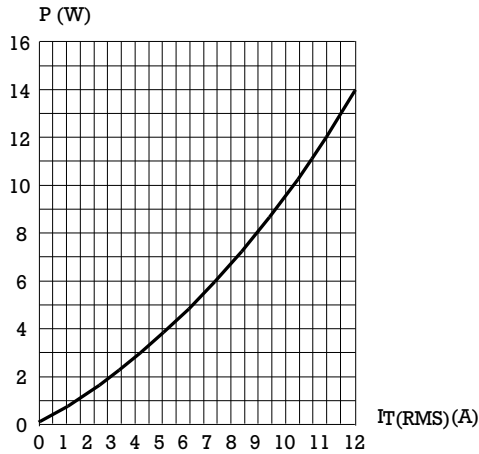

Fig. 2: RMS on-state current versus case temperature (full cycle).

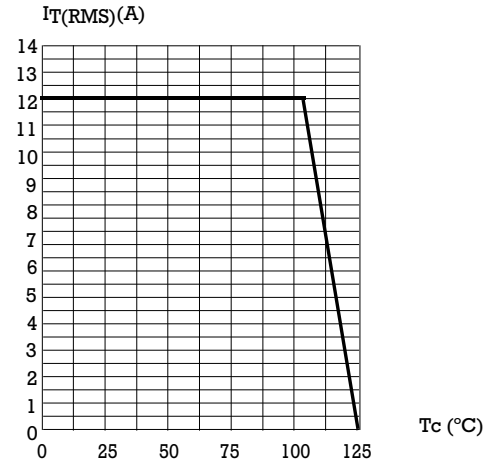

Fig. 3: Relative variation of thermal impedance versus pulse duration.

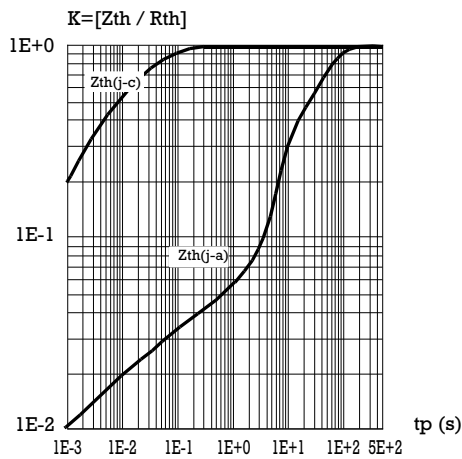

Fig. 4: On-state characteristics (maximum values)

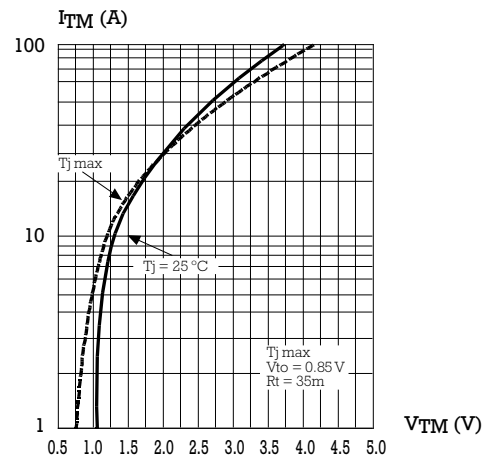
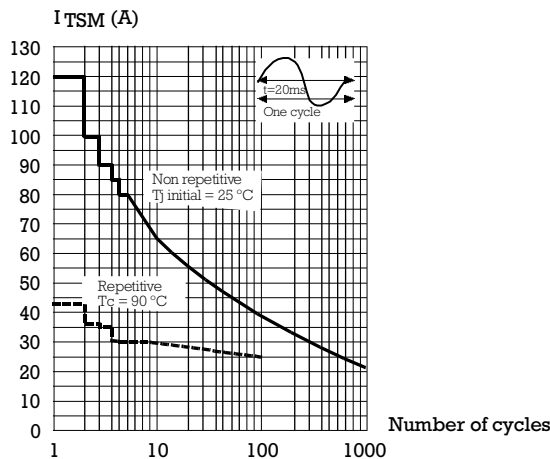
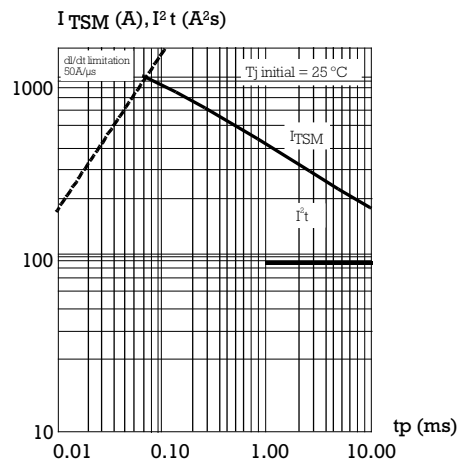

Fig. 5: Surge peak on-state current versus number of cycles

 Fig. 6: Non-repetitive surge peak on-state current for a sinusoidal pulse with width $t_p < 10\text{ms}$, and corresponding value of I^2t .

LOGIC LEVEL TRIAC

Fig. 7: Relative variation of gate trigger current, holding current and latching current versus junction temperature (typical values)

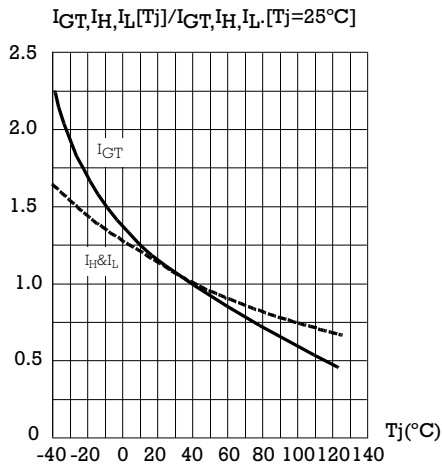
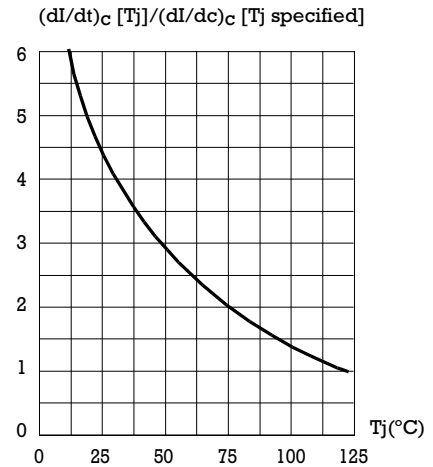

Fig. 8: Relative variation of critical rate of decrease of main current versus junction temperature



PACKAGE MECHANICAL DATA TO-220AB (Plastic)

