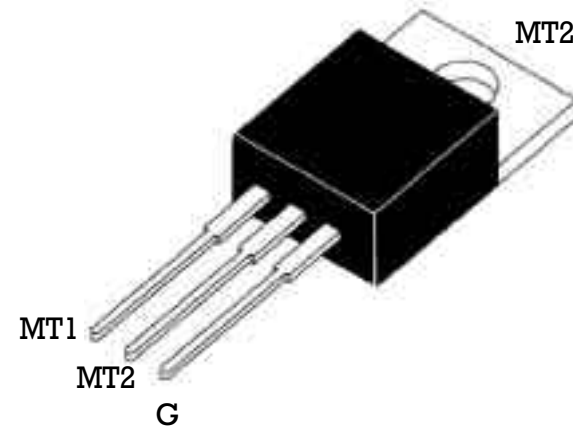

HIGH COMMUTATION TRIAC

<p style="text-align: center;">TO220-AB</p> 	<table style="width: 100%; border-collapse: collapse;"> <tr> <td style="width: 50%; text-align: center;">On-State Current</td> <td style="width: 50%; text-align: center;">Gate Trigger Current</td> </tr> <tr> <td style="text-align: center;">10 Amp</td> <td style="text-align: center;">25 mA to 50 mA</td> </tr> <tr> <td colspan="2" style="text-align: center; padding-top: 10px;">Off-State Voltage</td> </tr> <tr> <td colspan="2" style="text-align: center;">200 V ÷ 600 V</td> </tr> </table> <p style="margin-top: 20px;">This series of TRIACs uses a high performance PNP technology.</p> <p>These parts are intended for general purpose AC switching applications with highly inductive loads.</p>	On-State Current	Gate Trigger Current	10 Amp	25 mA to 50 mA	Off-State Voltage		200 V ÷ 600 V	
On-State Current	Gate Trigger Current								
10 Amp	25 mA to 50 mA								
Off-State Voltage									
200 V ÷ 600 V									

Absolute Maximum Ratings, according to IEC publication No. 134

SYMBOL	PARAMETER	CONDITIONS	Min.	Max.	Unit
$I_{T(RMS)}$	RMS On-state Current	All Conduction Angle, $T_C = 105^\circ C$	10		A
I_{TSM}	Non-repetitive On-State Current	Full Cycle, 60 Hz	105		A
I_{TSM}	Non-repetitive On-State Current	Full Cycle, 50 Hz	100		A
I^2t	Fusing Current	$t_p = 10$ ms, Half Cycle	55		A ² s
I_{GM}	Peak Gate Current	$20 \mu s$ max. $T_j = 125^\circ C$		4	A
$P_{G(AV)}$	Average Gate Power Dissipation	$T_j = 125^\circ C$		1	W
di/dt	Critical rate of rise of on-state current	$I_G = 2 \times I_{GT}$, $t_r = 100$ ns $f = 120$ Hz, $T_j = 125^\circ C$	50		A/ μs
T_j	Operating Temperature		-40	+125	$^\circ C$
T_{stg}	Storage Temperature		-40	+150	$^\circ C$

SYMBOL	PARAMETER	VOLTAGE			Unit
		B	D	M	
V_{DRM}	Repetitive Peak Off State Voltage	200	400	600	V
V_{RRM}					

HIGH COMMUTATION TRIAC

Electrical Characteristics

SYMBOL	PARAMETER	CONDITIONS	Quadrant		SENSITIVITY			Unit
					11	14	16	
$I_{CT}^{(1)}$	Gate Trigger Current	$V_D = 12 V_{DC}, R_L = 33 \Omega, T_j = 25^\circ C$	Q1÷Q3	MAX	25	35	50	mA
I_{DRM} / I_{RRM}	Off-State Leakage Current	$V_D = V_{DRM}, T_j = 125^\circ C$		MAX	1			mA
		$V_R = V_{RRM}, T_j = 25^\circ C$		MAX	5			μA
$V_{to}^{(2)}$	Threshold Voltage	$T_j = 125^\circ C$		MAX	0.85			V
$R_d^{(2)}$	Dynamic Resistance	$T_j = 125^\circ C$		MAX	40			m
$V_{TM}^{(2)}$	On-state Voltage	$I_T = 14 \text{ Amp}, t_p = 380 \mu s, T_j = 25^\circ C$		MAX	1.55			V
V_{GT}	Gate Trigger Voltage	$V_D = 12 V_{DC}, R_L = 33 \Omega, T_j = 25^\circ C$	Q1÷Q3	MAX	1.3			V
V_{GD}	Gate Non Trigger Current	$V_D = V_{DRM}, R_L = 3.3K \Omega, T_j = 125^\circ C$	Q1÷Q3	MIN	0.2			V
$I_H^{(2)}$	Holding Current	$I_T = 500 \text{ mA}, \text{ Gate open}, T_j = 25^\circ C$		MAX	25	35	50	mA
I_L	Latching Current	$I_G = 1.2 I_{CT}, T_j = 25^\circ C$	Q1,Q3	MAX	40	50	70	mA
			Q2	MAX	50	60	80	
$dv / dt^{(2)}$	Critical Rate of Voltage Rise	$V_D = 0.67 \times V_{DRM}, \text{ Gate open}$ $T_j = 125^\circ C$		MIN	200	500	1000	V/ μs
$(dI/dt)_c^{(2)}$	Critical Rate of Current Rise	$(dv/dt)_c = 0.1 \text{ V}/\mu s$ $(dv/dt)_c = 10 \text{ V}/\mu s$ without snubber $T_j = 125^\circ C$		MIN	-	-	-	A/ms
				MIN	-	-	-	
				MIN	5	5.5	9	
$R_{th(j-c)}$	Thermal Resistance Junction-Case	for AC 360° conduction angle			1.5			$^\circ C/W$
$R_{th(j-a)}$	Thermal Resistance Junction-Ambient				60			$^\circ C/W$

(1) Minimum I_{CT} is guaranteed at 5% of I_{CT} max.

(2) For either polarity of electrode MT2 voltage with reference to electrode MT1.

PART NUMBER INFORMATION

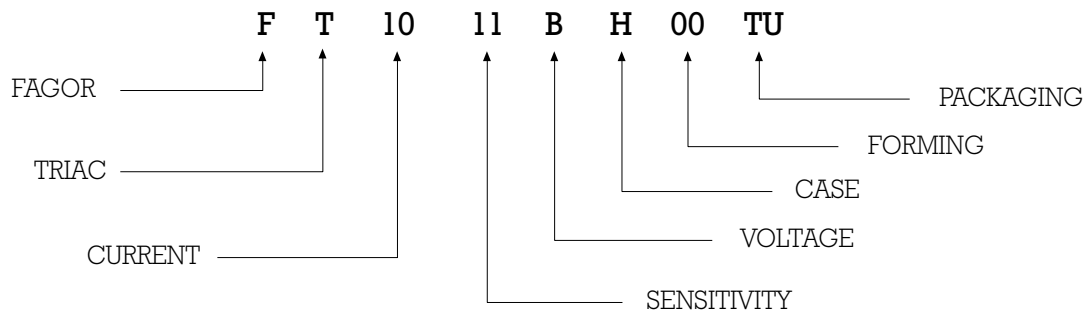

HIGH COMMUTATION TRIAC

Fig. 1: Maximum power dissipation versus RMS on-state current (full cycle).

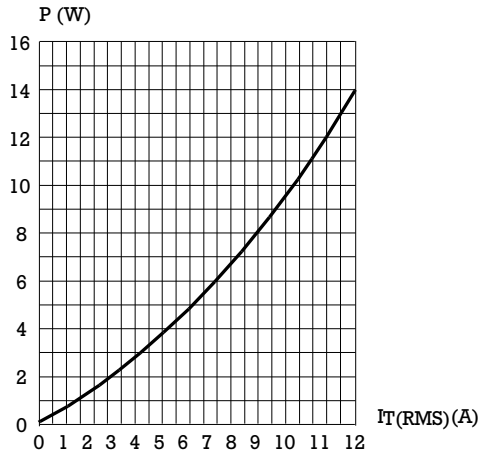

Fig. 2: RMS on-state current versus case temperature (full cycle).

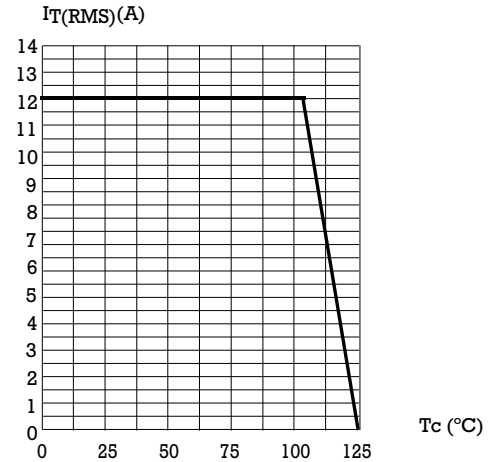

Fig. 3: Relative variation of thermal impedance versus pulse duration.

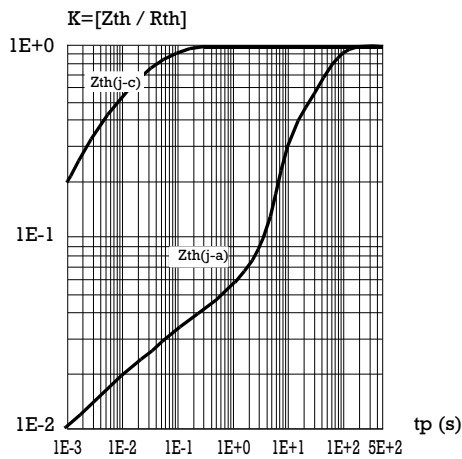

Fig. 4: On-state characteristics (maximum values)

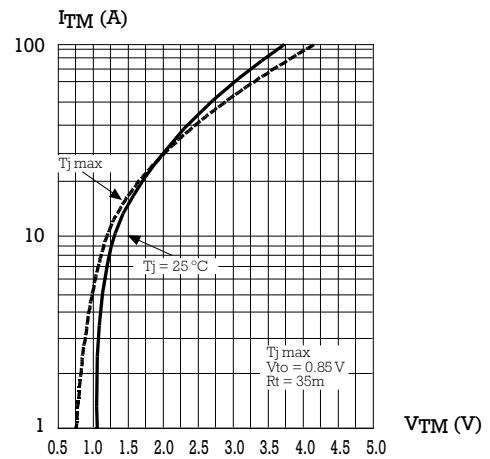

Fig. 5: Surge peak on-state current versus number of cycles

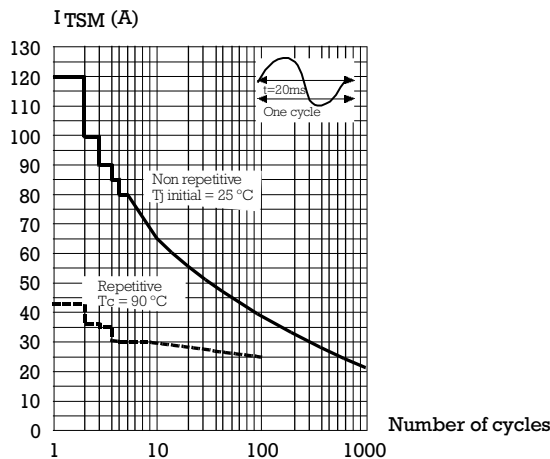
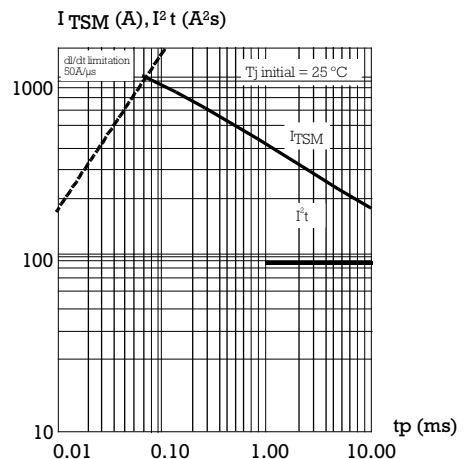

Fig. 6: Non-repetitive surge peak on-state current for a sinusoidal pulse with width $t_p < 10\text{ms}$, and corresponding value of I^2t .



HIGH COMMUTATION TRIAC

Fig. 7: Relative variation of gate trigger current, holding current and latching current versus junction temperature (typical values)

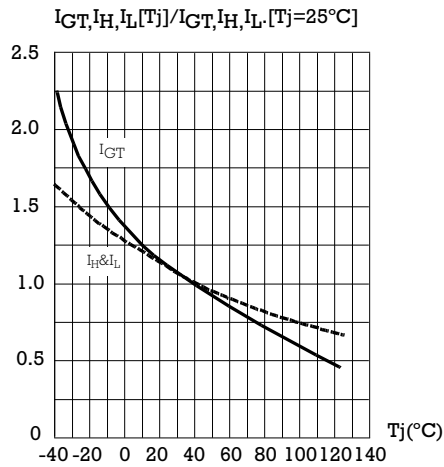
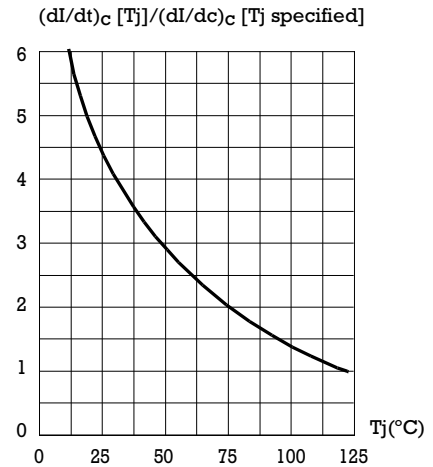

Fig. 8: Relative variation of critical rate of decrease of main current versus junction temperature



PACKAGE MECHANICAL DATA TO-220AB (Plastic)

