

74AC125 • 74ACT125 Quad Buffer with 3-STATE Outputs

General Description

The AC/ACT125 contains four independent non-inverting buffers with 3-STATE outputs.

Features

- I_{CC} reduced by 50%
- Outputs source/sink 24 mA
- ACT125 has TTL-compatible outputs

Ordering Code:

Order Number	Package Number	Package Description
74AC125SC	M14A	14-Lead Small Outline Integrated Circuit (SOIC), JEDEC MS-120, 0.150" Narrow Body
74AC125SJ	M14D	14-Lead Small Outline Package (SOP), EIAJ TYPE II, 5.3mm Wide
74AC125MTC	MTC14	14-Lead Thin Shrink Small Outline Package (TSSOP), JEDEC MO-153, 4.4mm Wide
74AC125PC	N14A	14-Lead Plastic Dual-in-Line Package (PDIP), JEDEC MS-001, 0.300" Wide
74ACT125SC	M14A	14-Lead Small Outline Integrated Circuit (SOIC), JEDEC MS-120, 0.150" Narrow Body
74ACT125SJ	M14D	14-Lead Small Outline Package (SOP), EIAJ TYPE II, 5.3mm Wide
74ACT125MTC	MTC14	14-Lead Thin Shrink Small Outline Package (TSSOP), JEDEC MO-153, 4.4mm Wide
74ACT125PC	N14A	14-Lead Plastic Dual-in-Line Package (PDIP), JEDEC MS-001, 0.300" Wide

Device also available in Tape and Reel. Specify by appending suffix letter "X" to the ordering code.

Logic Symbol

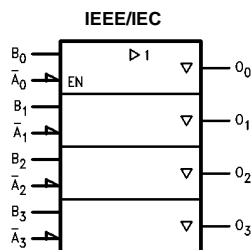

Connection Diagram

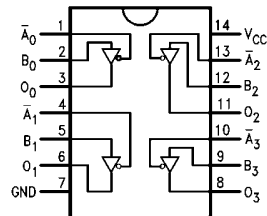

Pin Descriptions

Pin Names	Description
\bar{A}_n, B_n	Inputs
O_n	Outputs

Function Table

Inputs		Output
A_n	B_n	O_n
L	L	L
L	H	H
H	X	Z

H = HIGH Voltage Level
L = LOW Voltage Level
Z = HIGH Impedance
X = Immaterial

FACT™ is a trademark of Fairchild Semiconductor Corporation.

Absolute Maximum Ratings(Note 1)

Supply Voltage (V_{CC})	-0.5V to +7.0V
DC Input Diode Current (I_k)	
$V_i = -0.5V$	-20 mA
$V_i = V_{CC} + 0.5V$	+20 mA
DC Input Voltage (V_i)	-0.5V to $V_{CC} + 0.5V$
DC Output Diode Current (I_{OK})	
$V_o = -0.5V$	-20 mA
$V_o = V_{CC} + 0.5V$	+20 mA
DC Output Voltage (V_o)	-0.5V to $V_{CC} + 0.5V$
DC Output Source	
or Sink Current (I_o)	± 50 mA
DC V_{CC} or Ground Current	
per Output Pin (I_{CC} or I_{GND})	± 50 mA
Storage Temperature (T_{STG})	-65°C to +150°C
Junction Temperature (T_J)	
PDIP	140°C

Recommended Operating Conditions

Supply Voltage (V_{CC})	
AC	2.0V to 6.0V
ACT	4.5V to 5.5V
Input Voltage (V_i)	0V to V_{CC}
Output Voltage (V_o)	0V to V_{CC}
Operating Temperature (T_A)	-40°C to +85°C
Minimum Input Edge Rate ($\Delta V/\Delta t$)	
AC Devices	
V_{IN} from 30% to 70% of V_{CC}	
V_{CC} @ 3.3V, 4.5V, 5.5V	125 mV/ns
Minimum Input Edge Rate ($\Delta V/\Delta t$)	
ACT Devices	
V_{IN} from 0.8V to 2.0V	
V_{CC} @ 4.5V, 5.5V	125 mV/ns

Note 1: Absolute maximum ratings are those values beyond which damage to the device may occur. The databook specifications should be met, without exception, to ensure that the system design is reliable over its power supply, temperature, and output/input loading variables. Fairchild does not recommend operation of FACT™ circuits outside databook specifications.

DC Electrical Characteristics for AC

Symbol	Parameter	V_{CC} (V)	$T_A = +25^\circ\text{C}$		$T_A = -40^\circ\text{C to } +85^\circ\text{C}$	Units	Conditions
			Typ	Guaranteed Limits			
V_{IH}	Minimum HIGH Level Input Voltage	3.0	1.5	2.1	2.1	V	$V_{OUT} = 0.1V$ or $V_{CC} - 0.1V$
		4.5	2.25	3.15	3.15		
		5.5	2.75	3.85	3.85		
V_{IL}	Maximum LOW Level Input Voltage	3.0	1.5	0.9	0.9	V	$V_{OUT} = 0.1V$ or $V_{CC} - 0.1V$
		4.5	2.25	1.35	1.35		
		5.5	2.75	1.65	1.65		
V_{OH}	Minimum HIGH Level Output Voltage	3.0	2.99	2.9	2.9	V	$I_{OUT} = -50 \mu A$
		4.5	4.49	4.4	4.4		
		5.5	5.49	5.4	5.4		
		3.0		2.56	2.46	V	$V_{IN} = V_{IL}$ or V_{IH} $I_{OH} = -12$ mA $I_{OH} = -24$ mA $I_{OH} = -24$ mA (Note 2)
		4.5		3.86	3.76		
		5.5		4.86	4.76		
V_{OL}	Maximum LOW Level Output Voltage	3.0	0.002	0.1	0.1	V	$I_{OUT} = 50 \mu A$
		4.5	0.001	0.1	0.1		
		5.5	0.001	0.1	0.1		
		3.0		0.36	0.44	V	$V_{IN} = V_{IL}$ or V_{IH} $I_{OL} = 12$ mA $I_{OL} = 24$ mA $I_{OL} = 24$ mA (Note 2)
		4.5		0.36	0.44		
		5.5		0.36	0.44		
I_{IN} (Note 4)	Maximum Input Leakage Current	5.5		± 0.1	± 1.0	μA	$V_i = V_{CC}, GND$
I_{OZ}	Maximum 3-STATE Current	5.5		± 0.25	± 2.5	μA	V_i (OE) = V_{IL}, V_{IH} $V_i = V_{CC}, V_{GND}$ $V_o = V_{CC}, GND$
I_{OLD}	Minimum Dynamic	5.5			75	mA	$V_{OLD} = 1.65V$ Max
I_{OHD}	Output Current (Note 3)	5.5			-75	mA	$V_{OHD} = 3.85V$ Min
I_{CC} (Note 4)	Maximum Quiescent Supply Current	5.5		4.0	40.0	μA	$V_{IN} = V_{CC}$ or GND

Note 2: All outputs loaded; thresholds on input associated with output under test.

Note 3: Maximum test duration 2.0 ms, one output loaded at a time.

Note 4: Note: I_{IN} and I_{CC} @ 3.0V are guaranteed to be less than or equal to the respective limit @ 5.5V V_{CC} .

DC Electrical Characteristics for ACT

Symbol	Parameter	V _{CC} (V)	T _A = +25°C		T _A = -40°C to +85°C	Units	Conditions	
			Typ	Guaranteed Limits				
V _{IH}	Minimum HIGH Level Input Voltage	4.5	1.5	2.0	2.0	V	V _{OUT} = 0.1V or V _{CC} - 0.1V	
		5.5	1.5	2.0	2.0			
V _{IL}	Maximum LOW Level Input Voltage	4.5	1.5	0.8	0.8	V	V _{OUT} = 0.1V or V _{CC} - 0.1V	
		5.5	1.5	0.8	0.8			
V _{OH}	Minimum HIGH Level Output Voltage	4.5	4.49	4.4	4.4	V	I _{OUT} = -50 μA	
		5.5	5.49	5.4	5.4			
			4.5		3.86	3.76	V	V _{IN} = V _{IL} or V _{IH} I _{OH} = -24 mA I _{OH} = -24 mA (Note 5)
			5.5		4.86	4.76		
V _{OL}	Maximum LOW Level Output Voltage	4.5	0.001	0.1	0.1	V	I _{OUT} = 50 μA	
		5.5	0.001	0.1	0.1			
			4.5		0.36	0.44	V	V _{IN} = V _{IL} or V _{IH} I _{OL} = 24 mA I _{OL} = 24 mA (Note 5)
			5.5		0.36	0.44		
I _{IN}	Maximum Input Leakage Current	5.5		±0.1	±1.0	μA	V _I = V _{CC} , GND	
I _{OZ}	Maximum 3-STATE Current	5.5		±0.5	±5.0	μA	V _I = V _{IL} , V _{IH} V _O = V _{CC} , GND	
I _{CCT}	Maximum I _{CC} /Input	5.5	0.6		1.5	mA	V _I = V _{CC} - 2.1V (Note 7)	
I _{OLD}	Minimum Dynamic Output Current (Note 6)	5.5			75	mA	V _{OLD} = 1.65V Max	
I _{OHD}	Output Current (Note 6)	5.5			-75	mA	V _{OHD} = 3.85V Min	
I _{CC}	Maximum Quiescent Supply Current	5.5		4.0	40.0	μA	V _{IN} = V _{CC} or GND	

Note 5: All outputs loaded; thresholds on input associated with output under test.

Note 6: Maximum test duration 2.0 ms, one output loaded at a time.

Note 7: May be measured per the JEDEC Alternate Method.

AC Electrical Characteristics for AC

Symbol	Parameter	V _{CC} (V) (Note 8)	T _A = +25°C C _L = 50 pF			T _A = -40°C to +85°C C _L = 50 pF		Units
			Min	Typ	Max	Min	Max	
t _{PLH}	Propagation Delay	3.3	1.0	6.5	9.0	1.0	10.0	ns
	Data to Output	5.0	1.0	5.5	7.0	1.0	7.5	
t _{PHL}	Propagation Delay	3.3	1.0	6.5	9.0	1.0	10.0	ns
	Data to Output	5.0	1.0	5.0	7.0	1.0	7.5	
t _{PZH}	Output Enable Time	3.3	1.0	6.0	10.5	1.0	11.0	ns
		5.0	1.0	5.0	7.0	1.0	8.0	
t _{PZL}	Output Enable Time	3.3	1.0	7.5	10.0	1.0	11.0	ns
		5.0	1.0	5.5	8.0	1.0	8.5	
t _{PHZ}	Output Disable Time	3.3	1.0	7.5	10.0	1.0	10.5	ns
		5.0	1.0	6.5	9.0	1.0	9.5	
t _{PLZ}	Output Disable Time	3.3	1.0	7.5	10.5	1.0	11.5	ns
		5.0	1.0	6.5	9.0	1.0	9.5	

Note 8: Voltage Range 3.3 is 3.3V ± 0.3V
Voltage Range 5.0 is 5.0V ± 0.5V

AC Electrical Characteristics for ACT

Symbol	Parameter	V _{CC} (V) (Note 9)	T _A = +25°C C _L = 50 pF			T _A = -40°C to +85°C C _L = 50 pF		Units
			Min	Typ	Max	Min	Max	
t _{PLH}	Propagation Delay	5.0	1.0	6.5	9.0	1.0	10.0	ns
	Data to Output							
t _{PHL}	Propagation Delay	5.0	1.0	7.0	9.0	1.0	10.0	ns
	Data to Output							
t _{PZH}	Output Enable Time	5.0	1.0	6.0	8.5	1.0	9.5	ns
t _{PZL}	Output Enable Time	5.0	1.0	7.0	9.5	1.0	10.5	ns
t _{PHZ}	Output Disable Time	5.0	1.0	7.0	9.5	1.0	10.5	ns
t _{PLZ}	Output Disable Time	5.0	1.0	7.5	10.0	1.0	10.5	ns

Note 9: Voltage Range 5.0 is 5.0V ± 0.5V

Capacitance

Symbol	Parameter	AC/ACT	Units	Conditions
		Typ		
C _{IN}	Input Capacitance	4.5	pF	V _{CC} = OPEN
C _{PD}	Power Dissipation Capacitance	45.0	pF	V _{CC} = 5.0V

Physical Dimensions inches (millimeters) unless otherwise noted

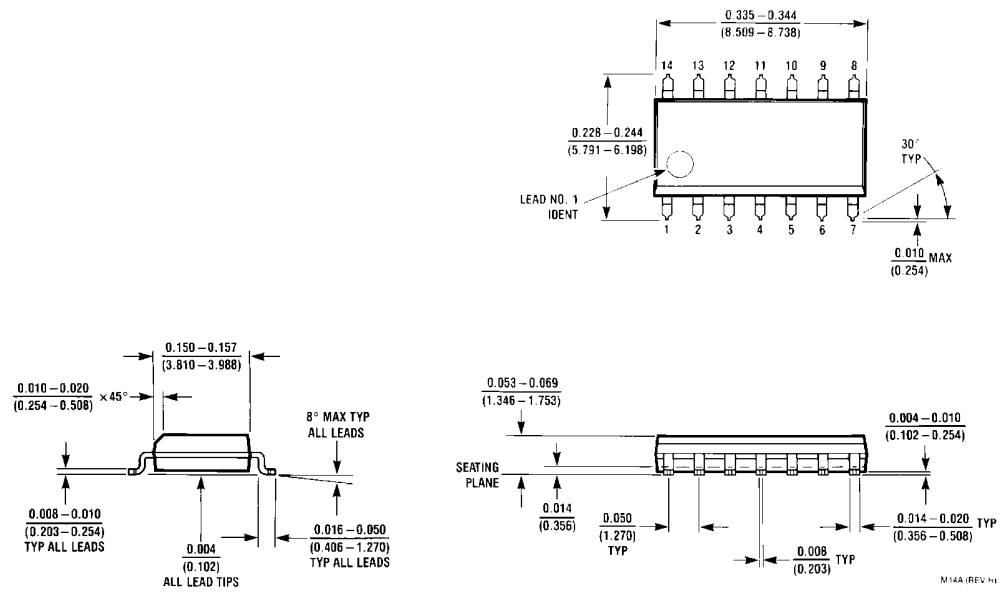

**14-Lead Small Outline Integrated Circuit (SOIC), JEDEC MS-120, 0.150" Narrow Body
Package Number M14A**

M14A (REV. H)

Physical Dimensions inches (millimeters) unless otherwise noted (Continued)

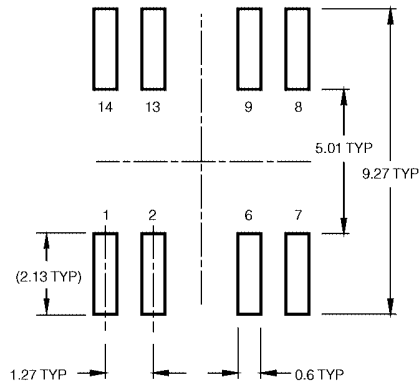
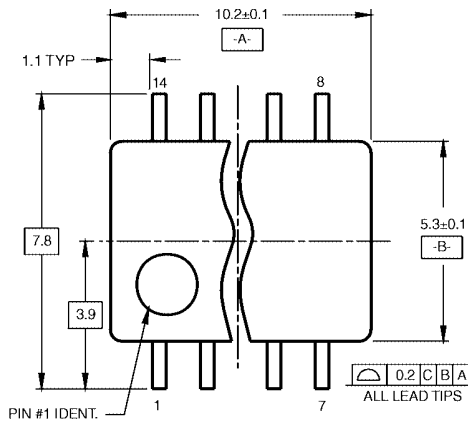

LAND PATTERN RECOMMENDATION

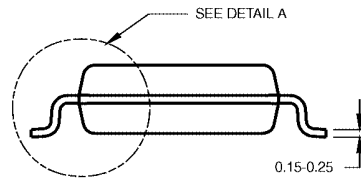
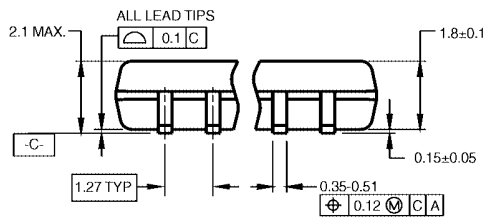

DIMENSIONS ARE IN MILLIMETERS

- NOTES:
 A. CONFORMS TO EIAJ EDR-7320 REGISTRATION, ESTABLISHED IN DECEMBER, 1998.
 B. DIMENSIONS ARE IN MILLIMETERS.
 C. DIMENSIONS ARE EXCLUSIVE OF BURRS, MOLD FLASH, AND TIE BAR EXTRUSIONS.

M14DRevB1

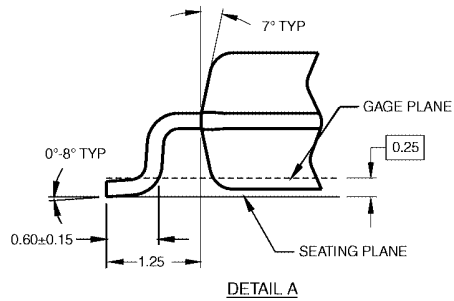

**14-Lead Small Outline Package (SOP), EIAJ TYPE II, 5.3mm Wide
 Package Number M14D**

Physical Dimensions inches (millimeters) unless otherwise noted (Continued)

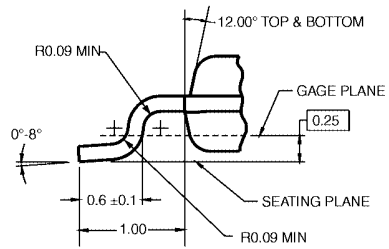
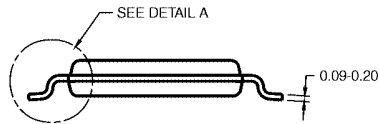
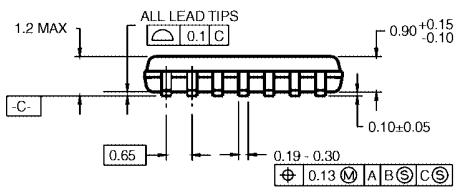
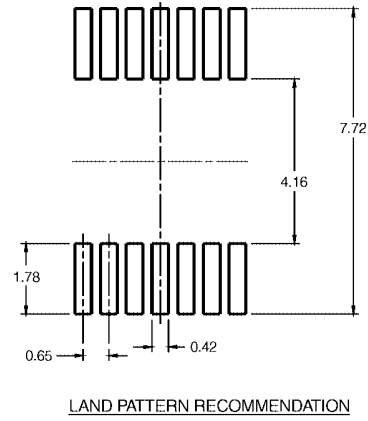
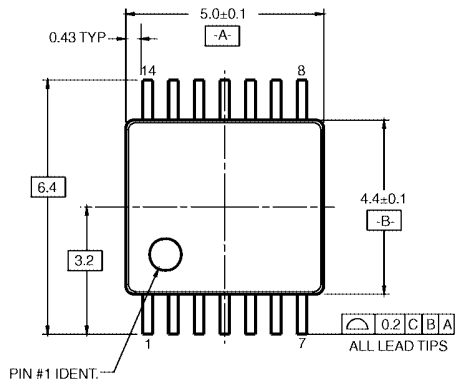

- NOTES:
 A. CONFORMS TO JEDEC REGISTRATION MO-153, VARIATION AB, REF NOTE 6, DATE 7/93.
 B. DIMENSIONS ARE IN MILLIMETERS.
 C. DIMENSIONS ARE EXCLUSIVE OF BURRS, MOLD FLASH, AND TIE BAR EXTRUSIONS.
 D. DIMENSIONS AND TOLERANCES PER ANSI Y14.5M, 1982.

MTC14RevC3

**14-Lead Thin Shrink Small Outline Package (TSSOP), JEDEC MO-153, 4.4mm Wide
 Package Number MTC14**

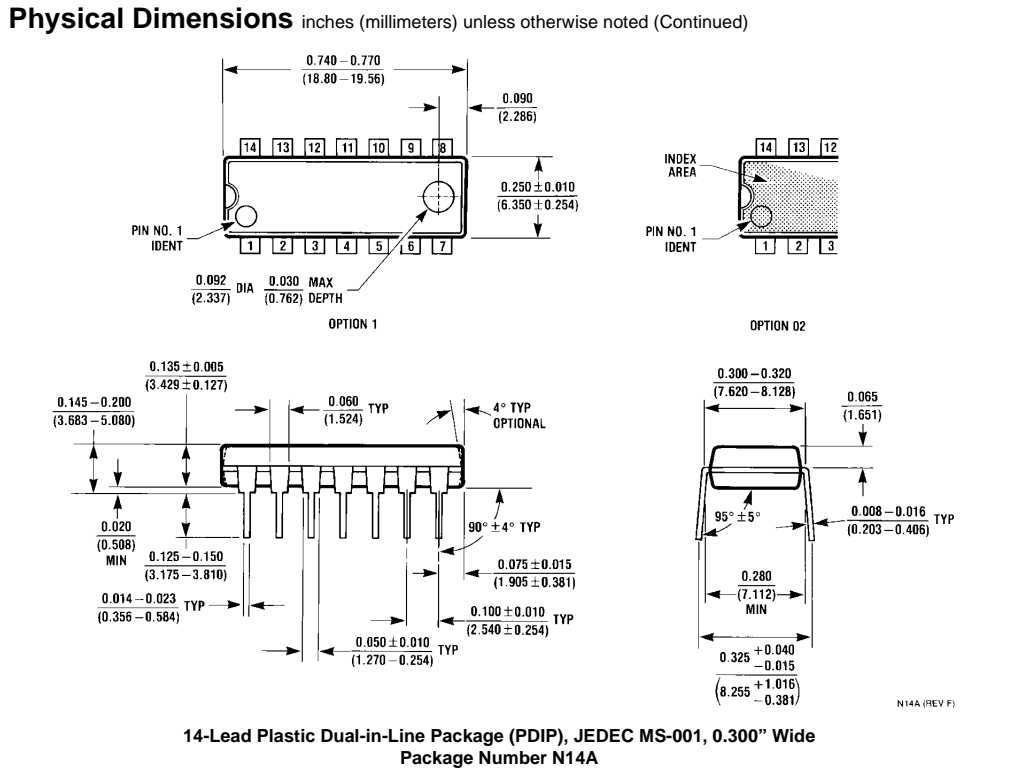

Fairchild does not assume any responsibility for use of any circuitry described, no circuit patent licenses are implied and Fairchild reserves the right at any time without notice to change said circuitry and specifications.

LIFE SUPPORT POLICY

FAIRCHILD'S PRODUCTS ARE NOT AUTHORIZED FOR USE AS CRITICAL COMPONENTS IN LIFE SUPPORT DEVICES OR SYSTEMS WITHOUT THE EXPRESS WRITTEN APPROVAL OF THE PRESIDENT OF FAIRCHILD SEMICONDUCTOR CORPORATION. As used herein:

1. Life support devices or systems are devices or systems which, (a) are intended for surgical implant into the body, or (b) support or sustain life, and (c) whose failure to perform when properly used in accordance with instructions for use provided in the labeling, can be reasonably expected to result in a significant injury to the user.
2. A critical component in any component of a life support device or system whose failure to perform can be reasonably expected to cause the failure of the life support device or system, or to affect its safety or effectiveness.

www.fairchildsemi.com