

74F125 Quad Buffer (3-STATE)

Features

- High impedance base inputs for reduced loading

Ordering Code:

Order Number	Package Number	Package Description
74F125SC	M14A	14-Lead Small Outline Integrated Circuit (SOIC), JEDEC MS-120, 0.150 Narrow
74F125SJ	M14D	14-Lead Small Outline Package (SOP), EIAJ TYPE II, 5.3mm Wide
74F125PC	N14A	14-Lead Plastic Dual-In-Line Package (PDIP), JEDEC MS-001, 0.300 Wide

Devices also available in Tape and Reel. Specify by appending the suffix letter "X" to the ordering code.

Logic Symbol

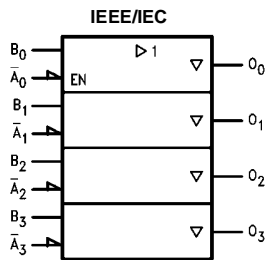

Connection Diagram

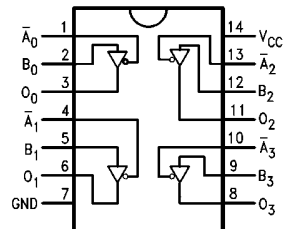

Unit Loading/Fan Out

Pin Names	Description	U.L. HIGH/LOW	Input I_{IH}/I_{IL} Output I_{OH}/I_{OL}
\bar{A}_n, B_n	Inputs	1.0/0.033	20 μ A/-20 μ A
O_n	Outputs	600/106.6 (80)	-12 mA/64 mA (48 mA)

Function Table

Inputs		Output
\bar{A}_n	B_n	O
L	L	L
L	H	H
H	X	Z

H = HIGH Voltage Level
L = LOW Voltage Level
Z = High Impedance
X = Immaterial

Absolute Maximum Ratings (Note 1)		Recommended Operating Conditions	
Storage Temperature	-65°C to +150°C	Free Air Ambient Temperature	0°C to +70°C
Ambient Temperature under Bias	-55°C to +125°C	Supply Voltage	+4.5V to +5.5V
Junction Temperature under Bias	-55°C to +150°C		
V _{CC} Pin Potential to Ground Pin	-0.5V to +7.0V		
Input Voltage (Note 2)	-0.5V to +7.0V		
Input Current (Note 2)	-30 mA to +5.0 mA		
Voltage Applied to Output in HIGH State (with V _{CC} = 0V)			
Standard Output	-0.5V to V _{CC}		
3-STATE Output	-0.5V to +5.5V		
Current Applied to Output in LOW State (Max)	twice the rated I _{OL} (mA)		

Note 1: Absolute maximum ratings are values beyond which the device may be damaged or have its useful life impaired. Functional operation under these conditions is not implied.

Note 2: Either voltage limit or current limit is sufficient to protect inputs.

DC Electrical Characteristics

Symbol	Parameter	Min	Typ	Max	Units	V _{CC}	Conditions
V _{IH}	Input HIGH Voltage	2.0			V		Recognized as a HIGH Signal
V _{IL}	Input LOW Voltage			0.8	V		Recognized as a LOW Signal
V _{CD}	Input Clamp Diode Voltage			-1.2	V	Min	I _{IN} = -18 mA
V _{OH}	Output HIGH Voltage	10% V _{CC} 2.4 10% V _{CC} 2.0 5% V _{CC} 2.7 5% V _{CC} 2.0			V	Min	I _{OH} = -3 mA I _{OH} = -12 mA I _{OH} = -3 mA I _{OH} = -15 mA
V _{OL}	Output LOW Voltage			0.55	V	Min	I _{OL} = 64 mA
I _{IH}	Input HIGH Current			20	μA	Max	V _{IN} = 2.7V
I _{BVI}	Input HIGH Current Breakdown Test			100	μA	0.0V	V _{IN} = 7.0V
I _{IL}	Input LOW Current			-20.0	μA	Max	V _{IN} = 0.5V
I _{OZH}	Output Leakage Current			50	μA	Max	V _{OUT} = 2.7V
I _{OZL}	Output Leakage Current			-50	μA	Max	V _{OUT} = 0.5V
I _{OS}	Output Short-Circuit Current	-100		-225	mA	Max	V _{OUT} = 0V
I _{CEx}	Output HIGH Leakage Current			250	μA	Max	V _{OUT} = V _{CC}
I _{ZZ}	Buss Drainage Test			500	μA	0.0V	V _{OUT} = 5.25V
I _{CCH}	Power Supply Current		18.5	24.0	mA	Max	V _O = HIGH
I _{CCL}	Power Supply Current		31.7	40.0	mA	Max	V _O = LOW
I _{CCZ}	Power Supply Current		27.6	35.0	mA	Max	V _O = HIGH Z

AC Electrical Characteristics

Symbol	Parameter	T _A = +25°C V _{CC} = +5.0V C _L = 50 pF			T _A = 0°C to +70°C V _{CC} = +5.0V C _L = 50 pF		Units
		Min	Typ	Max	Min	Max	
t _{PLH}	Propagation Delay	2.0	4.0	6.0	2.0	6.5	ns
t _{PHL}		3.0	4.6	7.5	3.0	8.0	
t _{PZH}	Output Enable Time	3.5	4.7	7.5	3.0	8.5	ns
t _{PZL}		3.5	5.3	8.0	3.5	9.0	
t _{PHZ}	Output Disable Time	1.5	3.9	5.5	1.5	6.0	ns
t _{PLZ}		1.5	4.0	6.0	1.5	6.5	

Physical Dimensions inches (millimeters) unless otherwise noted

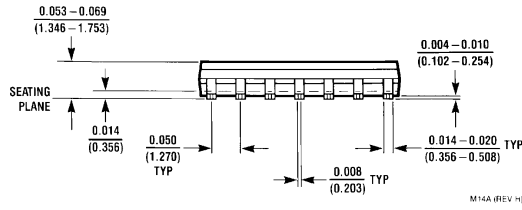
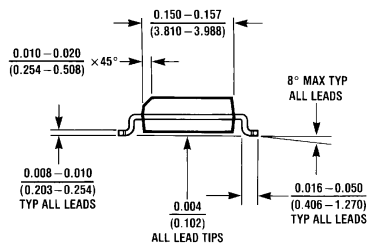
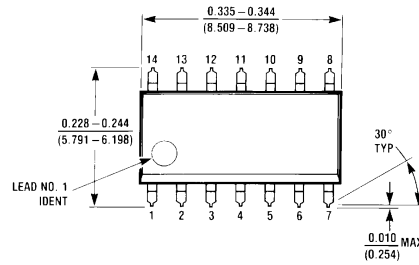

14-Lead Small Outline Integrated Circuit (SOIC), JEDEC MS-120, 0.150 Narrow Package Number M14A

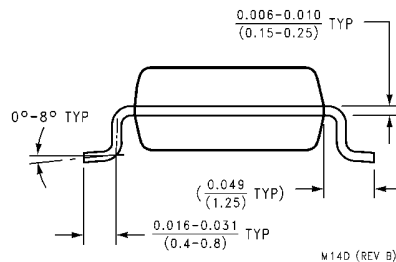
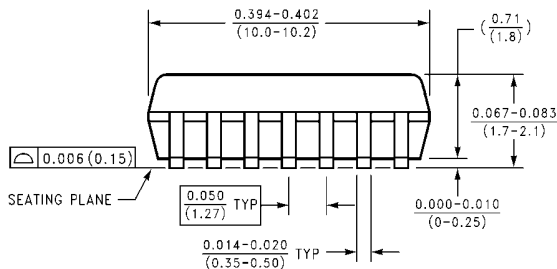
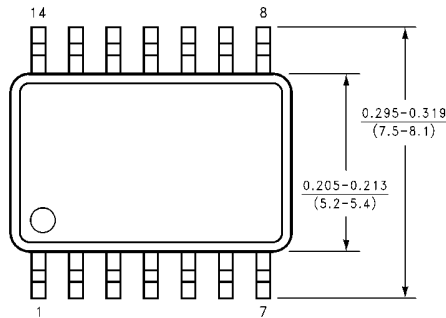

14-Lead Small Outline Package (SOP), EIAJ TYPE II, 5.3mm Wide Package Number M14D

Physical Dimensions inches (millimeters) unless otherwise noted (Continued)

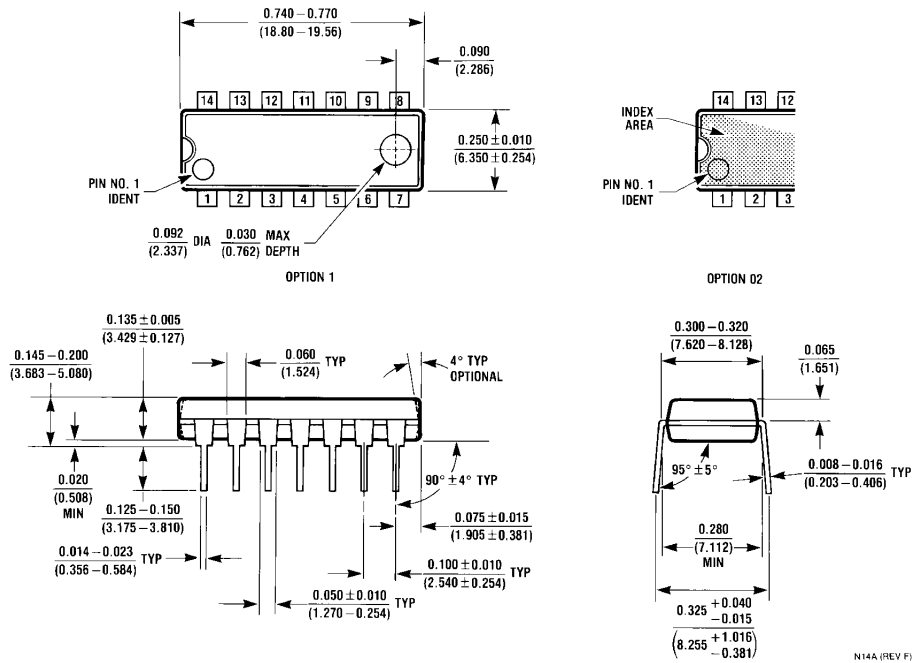

14-Lead Plastic Dual-In-Line Package (PDIP), JEDEC MS-001, 0.300 Wide Package Number N14A

Fairchild does not assume any responsibility for use of any circuitry described, no circuit patent licenses are implied and Fairchild reserves the right at any time without notice to change said circuitry and specifications.

LIFE SUPPORT POLICY

FAIRCHILD'S PRODUCTS ARE NOT AUTHORIZED FOR USE AS CRITICAL COMPONENTS IN LIFE SUPPORT DEVICES OR SYSTEMS WITHOUT THE EXPRESS WRITTEN APPROVAL OF THE PRESIDENT OF FAIRCHILD SEMICONDUCTOR CORPORATION. As used herein:

1. Life support devices or systems are devices or systems which, (a) are intended for surgical implant into the body, or (b) support or sustain life, and (c) whose failure to perform when properly used in accordance with instructions for use provided in the labeling, can be reasonably expected to result in a significant injury to the user.
2. A critical component in any component of a life support device or system whose failure to perform can be reasonably expected to cause the failure of the life support device or system, or to affect its safety or effectiveness.

www.fairchildsemi.com