

74F175 Quad D-Type Flip-Flop

General Description

The 74F175 is a high-speed quad D-type flip-flop. The device is useful for general flip-flop requirements where clock and clear inputs are common. The information on the D inputs is stored during the LOW-to-HIGH clock transition. Both true and complemented outputs of each flip-flop are provided. A Master Reset input resets all flip-flops, independent of the Clock or D inputs, LOW.

Features

- Edge-triggered D-type inputs
- Buffered positive edge-triggered clock
- Asynchronous common reset
- True and complement output

Ordering Code:

Order Number	Package Number	Package Description
74F175SC	M16A	16-Lead Small Outline Integrated Circuit (SOIC), JEDEC MS-012, 0.150 Narrow
74F175SJ	M16D	16-Lead Small Outline Package (SOP), EIAJ TYPE II, 5.3mm Wide
74F175PC	N16E	16-Lead Plastic Dual-In-Line Package (PDIP), JEDEC MS-001, 0.300 Wide

Devices also available in Tape and Reel. Specify by appending the suffix letter "X" to the ordering code.

Logic Symbols

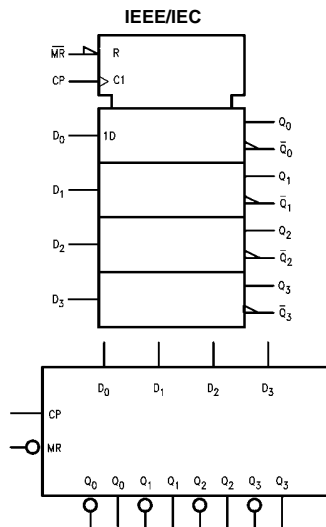

Connection Diagram

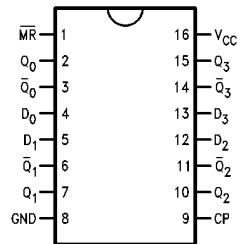

Unit Loading/Fan Out

Pin Names	Description	U.L.	
		HIGH/LOW	Input I_{IH}/I_{IL} Output I_{OH}/I_{OL}
D ₀ -D ₃	Data Inputs	1.0/1.0	20 μ A/-0.6 mA
CP	Clock Pulse Input (Active Rising Edge)	1.0/1.0	20 μ A/-0.6 mA
\overline{MR}	Master Reset Input (Active LOW)	1.0/1.0	20 μ A/-0.6 mA
Q ₀ -Q ₃	True Outputs	50/33.3	-1 mA/20 mA
$\overline{Q_0}$ - $\overline{Q_3}$	Complement Outputs	50/33.3	-1 mA/20 mA

Functional Description

The 74F175 consists of four edge-triggered D-type flip-flops with individual D inputs and Q and \overline{Q} outputs. The Clock and Master Reset are common. The four flip-flops will store the state of their individual D inputs on the LOW-to-HIGH clock (CP) transition, causing individual Q and \overline{Q} outputs to follow. A LOW input on the Master Reset (\overline{MR}) will force all Q outputs LOW and \overline{Q} outputs HIGH independent of Clock or Data inputs. The 74F175 is useful for general logic applications where a common Master Reset and Clock are acceptable.

Truth Table

Inputs			Outputs	
\overline{MR}	CP	D _n	Q _n	$\overline{Q_n}$
L	X	X	L	H
H	↗	H	H	L
H	↗	L	L	H

H = HIGH Voltage Level
 L = LOW Voltage Level
 X = Immaterial
 ↗ = LOW-to-HIGH Clock Transition

Logic Diagram

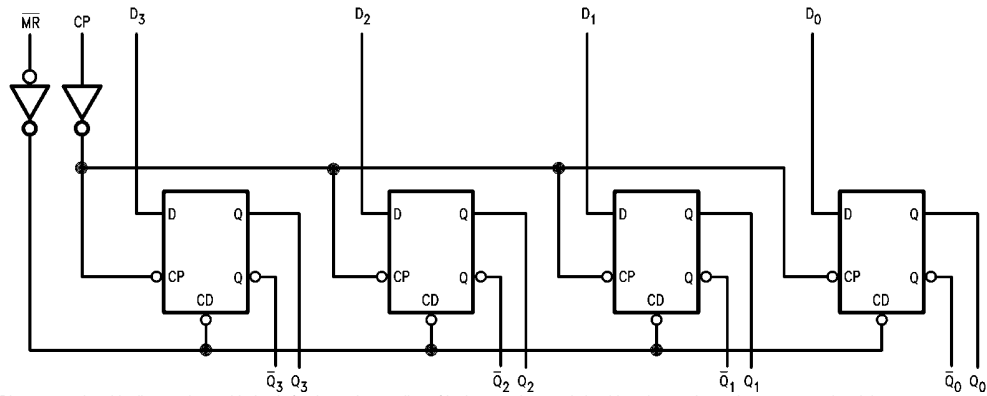

Please note that this diagram is provided only for the understanding of logic operations and should not be used to estimate propagation delays.

Absolute Maximum Ratings (Note 1)

Storage Temperature	-65°C to +150°C
Ambient Temperature under Bias	-55°C to +125°C
Junction Temperature under Bias	-55°C to +150°C
V _{CC} Pin Potential to Ground Pin	-0.5V to +7.0V
Input Voltage (Note 2)	-0.5V to +7.0V
Input Current (Note 2)	-30 mA to +5.0 mA
Voltage Applied to Output in HIGH State (with V _{CC} = 0V)	
Standard Output	-0.5V to V _{CC}
3-STATE Output	-0.5V to +5.5V
Current Applied to Output in LOW State (Max)	twice the rated I _{OL} (mA)

Recommended Operating Conditions

Free Air Ambient Temperature	0°C to +70°C
Supply Voltage	+4.5V to +5.5V

Note 1: Absolute maximum ratings are values beyond which the device may be damaged or have its useful life impaired. Functional operation under these conditions is not implied.

Note 2: Either voltage limit or current limit is sufficient to protect inputs.

DC Electrical Characteristics

Symbol	Parameter	Min	Typ	Max	Units	V _{CC}	Conditions
V _{IH}	Input HIGH Voltage	2.0			V		Recognized as a HIGH Signal
V _{IL}	Input LOW Voltage			0.8	V		Recognized as a LOW Signal
V _{CD}	Input Clamp Diode Voltage			-1.2	V	Min	I _{IN} = -18 mA
V _{OH}	Output HIGH Voltage	10% V _{CC} 5% V _{CC}	2.5 2.7		V	Min	I _{OH} = -1 mA I _{OH} = -1 mA
V _{OL}	Output LOW Voltage	10% V _{CC}		0.5	V	Min	I _{OL} = 20 mA
I _{IH}	Input HIGH Current			5.0	μA	Max	V _{IN} = 2.7V
I _{BVI}	Input HIGH Current Breakdown Test			7.0	μA	Max	V _{IN} = 7.0V
I _{CEX}	Output HIGH Leakage Current			50	μA	Max	V _{OUT} = V _{CC}
V _{ID}	Input Leakage Test	4.75			V	0.0	I _{ID} = 1.9 μA All Other Pins Grounded
I _{OD}	Output Leakage Circuit Current			3.75	μA	0.0	V _{ID} = 150 mV All Other Pins Grounded
I _{IL}	Input LOW Current			-0.6	mA	Max	V _{IN} = 0.5V
I _{OS}	Output Short-Circuit Current	-60		-150	mA	Max	V _{OUT} = 0V
I _{CC}	Power Supply Current		22.5	34.0	mA	Max	CP =  D _n = MR = HIGH

AC Electrical Characteristics									
Symbol	Parameter	T _A = +25°C V _{CC} = +5.0V C _L = 50 pF			T _A = -55°C to +125°C V _{CC} = +5.0V C _L = 50 pF		T _A = 0°C to +70°C V _{CC} = +5.0V C _L = 50 pF		Units
		Min	Typ	Max	Min	Max	Min	Max	
f _{MAX}	Maximum Clock Frequency	100	140		80		100		MHz
t _{PLH}	Propagation Delay CP to Q _n or \overline{Q}_n	4.0	5.0	6.5	3.5	8.5	4.0	7.5	ns
t _{PHL}	Propagation Delay \overline{MR} to Q _n	4.0	6.5	8.5	4.0	10.5	4.0	9.5	ns
t _{PHL}	Propagation Delay \overline{MR} to Q _n	4.5	9.0	11.5	4.5	15.0	4.5	13.0	ns
t _{PLH}	Propagation Delay MR to Q _n	4.0	6.5	8.0	4.0	10.0	4.0	9.0	ns
AC Operating Requirements									
Symbol	Parameter	T _A = +25°C V _{CC} = +5.0V		T _A = -55°C to +125°C V _{CC} = +5.0V		T _A = 0°C to +70°C V _{CC} = +5.0V		Units	
		Min	Max	Min	Max	Min	Max		
t _S (H)	Setup Time, HIGH or LOW	3.0		3.0		3.0		ns	
t _S (L)	D _n to CP	3.0		3.0		3.0			
t _H (H)	Hold Time, HIGH or LOW	1.0		1.0		1.0		ns	
t _H (L)	D _n to CP	1.0		2.0		1.0			
t _W (H)	CP Pulse Width HIGH or LOW	4.0		4.0		4.0		ns	
t _W (L)	HIGH or LOW	5.0		5.0		5.0			
t _W (L)	\overline{MR} Pulse Width, LOW	5.0		5.0		5.0		ns	
t _{REC}	Recovery Time, \overline{MR} to CP	5.0		5.0		5.0		ns	

Physical Dimensions inches (millimeters) unless otherwise noted

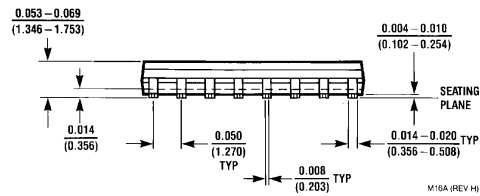
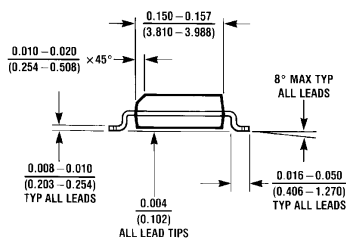
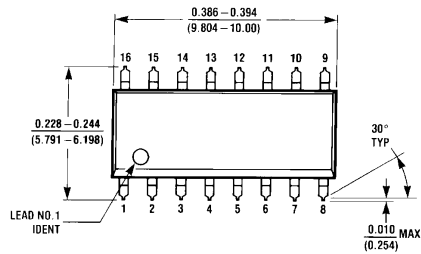

16-Lead Small Outline Integrated Circuit (SOIC), JEDEC MS-012, 0.150 Narrow Package Number M16A

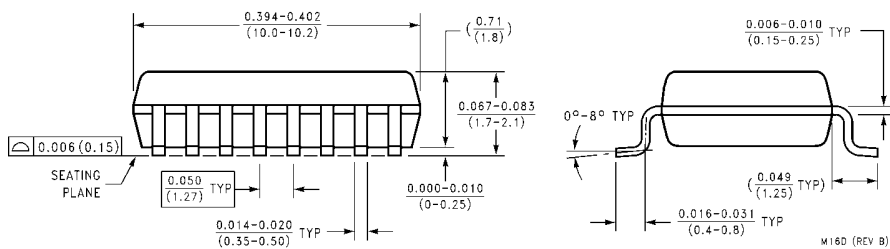
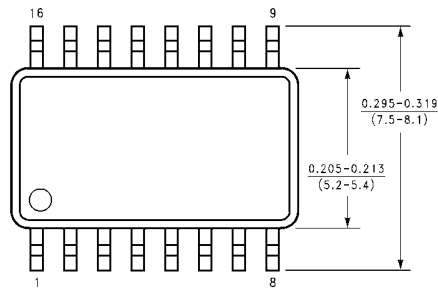

16-Lead Small Outline Package (SOP), EIAJ TYPE II, 5.3mm Wide Package Number M16D

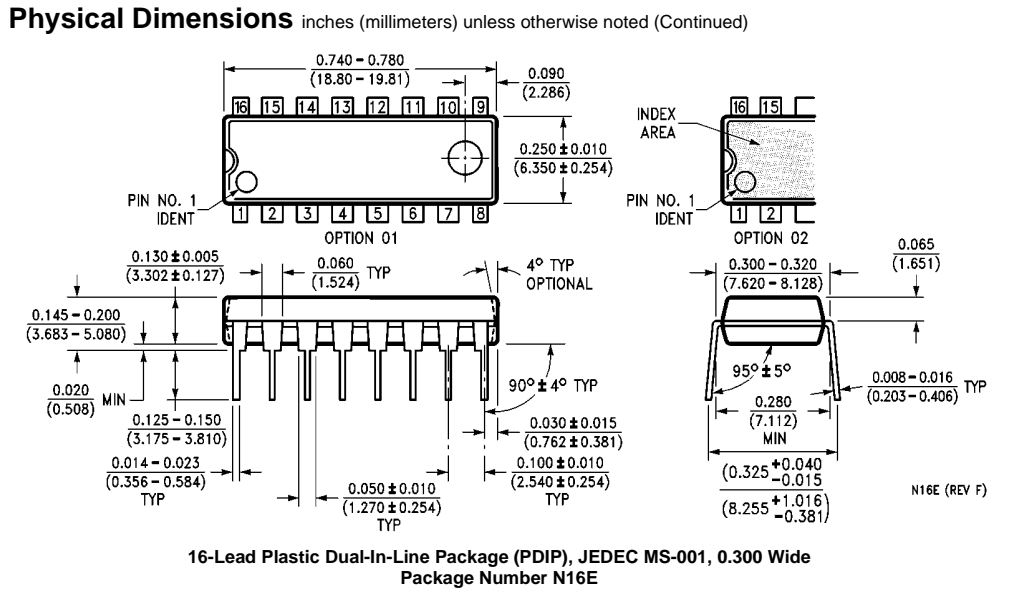

Fairchild does not assume any responsibility for use of any circuitry described, no circuit patent licenses are implied and Fairchild reserves the right at any time without notice to change said circuitry and specifications.

LIFE SUPPORT POLICY

FAIRCHILD'S PRODUCTS ARE NOT AUTHORIZED FOR USE AS CRITICAL COMPONENTS IN LIFE SUPPORT DEVICES OR SYSTEMS WITHOUT THE EXPRESS WRITTEN APPROVAL OF THE PRESIDENT OF FAIRCHILD SEMICONDUCTOR CORPORATION. As used herein:

1. Life support devices or systems are devices or systems which, (a) are intended for surgical implant into the body, or (b) support or sustain life, and (c) whose failure to perform when properly used in accordance with instructions for use provided in the labeling, can be reasonably expected to result in a significant injury to the user.
2. A critical component in any component of a life support device or system whose failure to perform can be reasonably expected to cause the failure of the life support device or system, or to affect its safety or effectiveness.

www.fairchildsemi.com