

## 74F251A 8-Input Multiplexer with 3-STATE Outputs

### General Description

The 74F251A is a high-speed 8-input digital multiplexer. It provides, in one package, the ability to select one bit of data from up to eight sources. It can be used as a universal function generator to generate any logic function of four variables. Both assertion and negation outputs are provided.

### Features

- Multifunctional capability
- On-chip select logic decoding
- Inverting and non-inverting 3-STATE outputs

### Ordering Code:

Order Number	Package Number	Package Description
74F251ASC	M16A	16-Lead Small Outline Integrated Circuit (SOIC), JEDEC MS-012, 0.150 Narrow
74F251ASJ	M16D	16-Lead Small Outline Package (SOP), EIAJ TYPE II, 5.3mm Wide
74F251APC	N16E	16-Lead Plastic Dual-In-Line Package (PDIP), JEDEC MS-001, 0.300 Wide

Devices also available in Tape and Reel. Specify by appending the suffix letter "X" to the ordering code.

### Logic Symbols

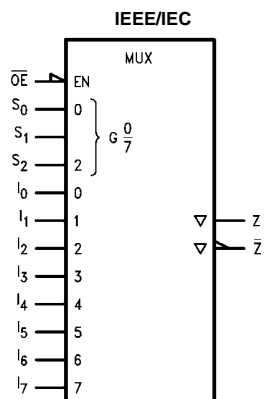
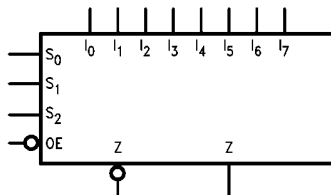

### Connection Diagram

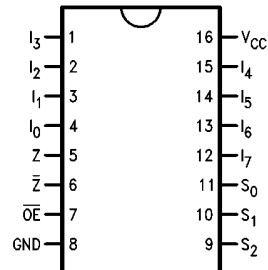

### Unit Loading/Fan Out

Pin Names	Description	U.L. HIGH/LOW	Input $I_{IH}/I_{IL}$ Output $I_{OH}/I_{OL}$
$S_0$ - $S_2$	Select Inputs	1.0/1.0	20 $\mu$ A/-0.6 mA
$\overline{OE}$	3-STATE Output Enable Input (Active LOW)	1.0/1.0	20 $\mu$ A/-0.6 mA
$I_0$ - $I_7$	Multiplexer Inputs	1.0/1.0	20 $\mu$ A/-0.6 mA
Z	3-STATE Multiplexer Output	150/40 (33.3)	-3 mA/24 mA (20 mA)
$\overline{Z}$	Complementary 3-STATE Multiplexer Output	150/40 (33.3)	-3 mA/24 mA (20 mA)

### Functional Description

This device is a logical implementation of a single-pole, 8-position switch with the switch position controlled by the state of three Select inputs,  $S_0, S_1, S_2$ . Both assertion and negation outputs are provided. The Output Enable input ( $\overline{OE}$ ) is active LOW. When it is activated, the logic function provided at the output is:

$$Z = \overline{OE} \cdot (I_0 \cdot \overline{S_0} \cdot \overline{S_1} \cdot \overline{S_2} + I_1 \cdot S_0 \cdot \overline{S_1} \cdot \overline{S_2} + I_2 \cdot \overline{S_0} \cdot S_1 \cdot \overline{S_2} + I_3 \cdot S_0 \cdot S_1 \cdot \overline{S_2} + I_4 \cdot \overline{S_0} \cdot \overline{S_1} \cdot S_2 + I_5 \cdot S_0 \cdot \overline{S_1} \cdot S_2 + I_6 \cdot \overline{S_0} \cdot S_1 \cdot S_2 + I_7 \cdot S_0 \cdot S_1 \cdot S_2)$$

When the Output Enable is HIGH, both outputs are in the high impedance (High Z) state. This feature allows multiplexer expansion by tying the outputs of up to 128 devices together. When the outputs of the 3-STATE devices are tied together, all but one device must be in the high impedance state to avoid high currents that would exceed the maximum ratings. The Output Enable signals should be designed to ensure there is no overlap in the active LOW portion of the enable voltages.

### Truth Table

$\overline{OE}$	Inputs			Outputs	
	$S_2$	$S_1$	$S_0$	$\overline{Z}$	Z
H	X	X	X	Z	Z
L	L	L	L	$\overline{I_0}$	$I_0$
L	L	L	H	$\overline{I_1}$	$I_1$
L	L	H	L	$\overline{I_2}$	$I_2$
L	L	H	H	$\overline{I_3}$	$I_3$
L	H	L	L	$\overline{I_4}$	$I_4$
L	H	L	H	$\overline{I_5}$	$I_5$
L	H	H	L	$\overline{I_6}$	$I_6$
L	H	H	H	$\overline{I_7}$	$I_7$

H = HIGH Voltage Level  
L = LOW Voltage Level  
X = Immaterial  
Z = High Impedance

### Logic Diagram

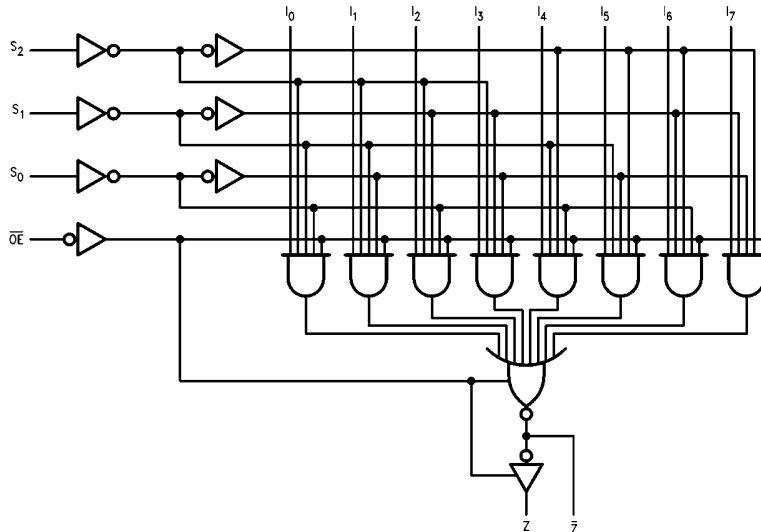

Please note that this diagram is provided only for the understanding of logic operations and should not be used to estimate propagation delays.

**Absolute Maximum Ratings**(Note 1)

Storage Temperature	-65°C to +150°C
Ambient Temperature under Bias	-55°C to +125°C
Junction Temperature under Bias	-55°C to +150°C
V <sub>CC</sub> Pin Potential to Ground Pin	-0.5V to +7.0V
Input Voltage (Note 2)	-0.5V to +7.0V
Input Current (Note 2)	-30 mA to +5.0 mA
Voltage Applied to Output in HIGH State (with V <sub>CC</sub> = 0V)	
Standard Output	-0.5V to V <sub>CC</sub>
3-STATE Output	-0.5V to +5.5V
Current Applied to Output in LOW State (Max)	twice the rated I <sub>OL</sub> (mA)

**Recommended Operating Conditions**

Free Air Ambient Temperature	0°C to +70°C
Supply Voltage	+4.5V to +5.5V

**Note 1:** Absolute maximum ratings are values beyond which the device may be damaged or have its useful life impaired. Functional operation under these conditions is not implied.

**Note 2:** Either voltage limit or current limit is sufficient to protect inputs.

**DC Electrical Characteristics**

Symbol	Parameter	Min	Typ	Max	Units	V <sub>CC</sub>	Conditions
V <sub>IH</sub>	Input HIGH Voltage	2.0			V		Recognized as a HIGH Signal
V <sub>IL</sub>	Input LOW Voltage			0.8	V		Recognized as a LOW Signal
V <sub>CD</sub>	Input Clamp Diode Voltage			-1.2	V	Min	I <sub>IN</sub> = -18 mA
V <sub>OH</sub>	Output HIGH Voltage	10% V <sub>CC</sub>	2.5		V	Min	I <sub>OH</sub> = -1 mA
		10% V <sub>CC</sub>	2.4	I <sub>OH</sub> = -3 mA			
		5% V <sub>CC</sub>	2.7	I <sub>OH</sub> = -1 mA			
		5% V <sub>CC</sub>	2.7	I <sub>OH</sub> = -3 mA			
V <sub>OL</sub>	Output LOW Voltage			0.5	V	Min	I <sub>OL</sub> = 24 mA
I <sub>IH</sub>	Input HIGH Current			5.0	μA	Max	V <sub>IN</sub> = 2.7V
I <sub>BVI</sub>	Input HIGH Current Breakdown Test			7.0	μA	Max	V <sub>IN</sub> = 7.0V
I <sub>CEX</sub>	Output HIGH Leakage Current			50	μA	Max	V <sub>OUT</sub> = V <sub>CC</sub>
V <sub>ID</sub>	Input Leakage Test	4.75			V	0.0	I <sub>ID</sub> = 1.9 μA All Other Pins Grounded
I <sub>OD</sub>	Output Leakage Circuit Current			3.75	μA	0.0	V <sub>IOD</sub> = 150 mV All Other Pins Grounded
I <sub>IL</sub>	Input LOW Current			-0.6	mA	Max	V <sub>IN</sub> = 0.5V
I <sub>OZH</sub>	Output Leakage Current			50	μA	Max	V <sub>OUT</sub> = 2.7V
I <sub>OZL</sub>	Output Leakage Current			-50	μA	Max	V <sub>OUT</sub> = 0.5V
I <sub>OS</sub>	Output Short-Circuit Current	-60		-150	mA	Max	V <sub>OUT</sub> = 0V
I <sub>ZZ</sub>	Bus Drainage Test			500	μA	0.0V	V <sub>OUT</sub> = 5.25V
I <sub>CCL</sub>	Power Supply Current		15	22	mA	Max	V <sub>O</sub> = LOW
I <sub>CCZ</sub>	Power Supply Current		16	24	mA	Max	V <sub>O</sub> = HIGH Z

AC Electrical Characteristics									
Symbol	Parameter	T <sub>A</sub> = +25°C V <sub>CC</sub> = +5.0V C <sub>L</sub> = 50 pF			T <sub>A</sub> = -55°C to +125°C V <sub>CC</sub> = 5.0V C <sub>L</sub> = 50 pF		T <sub>A</sub> = 0°C to +70°C V <sub>CC</sub> = 5.0V C <sub>L</sub> = 50 pF		Units
		Min	Typ	Max	Min	Max	Min	Max	
t <sub>PLH</sub>	Propagation Delay	3.5	6.0	9.0	3.5	11.5	3.5	9.5	ns
t <sub>PHL</sub>	S <sub>n</sub> to $\bar{Z}$	3.2	5.0	7.5	3.2	8.0	3.2	7.5	
t <sub>PLH</sub>	Propagation Delay	4.5	7.5	10.5	3.5	14.0	4.5	12.5	ns
t <sub>PHL</sub>	S <sub>n</sub> to Z	4.0	6.0	8.5	3.0	10.5	4.0	9.0	
t <sub>PLH</sub>	Propagation Delay	3.0	5.0	6.5	2.5	8.0	3.0	7.0	ns
t <sub>PHL</sub>	I <sub>n</sub> to $\bar{Z}$	1.5	2.5	4.0	1.5	6.0	1.5	5.0	
t <sub>PLH</sub>	Propagation Delay	3.5	5.0	7.0	2.5	9.0	2.5	8.0	ns
t <sub>PHL</sub>	I <sub>n</sub> to Z	3.5	5.5	7.0	3.5	9.0	3.5	7.5	
t <sub>PZH</sub>	Output Enable Time	2.5	4.3	6.0	2.0	7.0	2.5	7.0	ns
t <sub>PZL</sub>	$\overline{OE}$ to $\bar{Z}$	2.5	4.3	6.0	2.5	7.5	2.5	6.5	
t <sub>PHZ</sub>	Output Disable Time	2.5	4.0	5.5	2.5	6.0	2.5	6.0	ns
t <sub>PLZ</sub>	$\overline{OE}$ to $\bar{Z}$	1.5	3.0	4.5	1.5	5.0	1.5	4.5	
t <sub>PZH</sub>	Output Enable Time	3.5	5.0	7.0	3.0	8.5	3.0	7.5	ns
t <sub>PZL</sub>	$\overline{OE}$ to Z	3.5	5.5	7.5	3.5	9.0	3.5	8.0	
t <sub>PHZ</sub>	Output Disable Time	2.0	3.8	5.5	2.0	5.5	2.0	5.5	ns
t <sub>PLZ</sub>	$\overline{OE}$ to Z	1.5	3.0	4.5	1.5	5.5	1.5	4.5	

**Physical Dimensions** inches (millimeters) unless otherwise noted

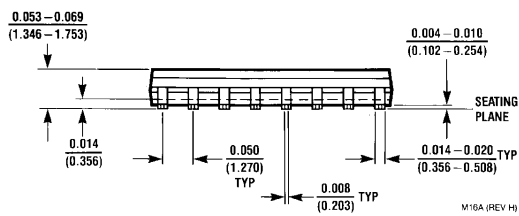
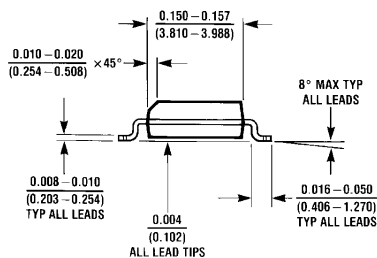
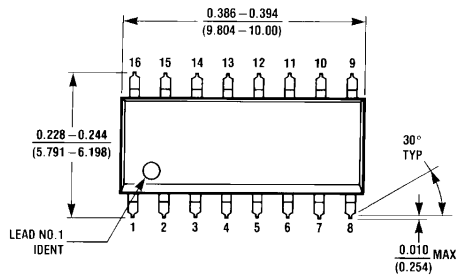

**16-Lead Small Outline Integrated Circuit (SOIC), JEDEC MS-012, 0.150 Narrow Package Number M16A**

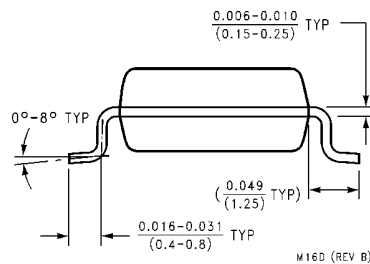
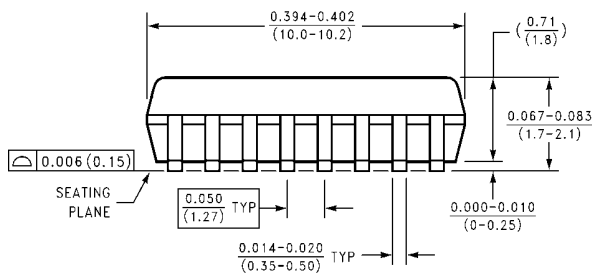
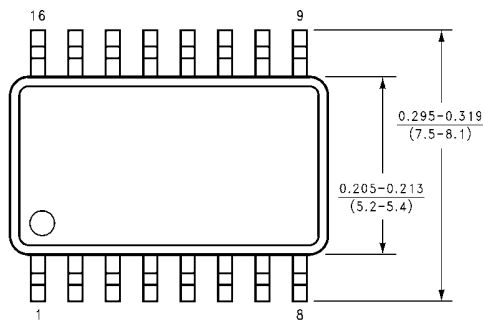

**16-Lead Small Outline Package (SOP), EIAJ TYPE II, 5.3mm Wide Package Number M16D**

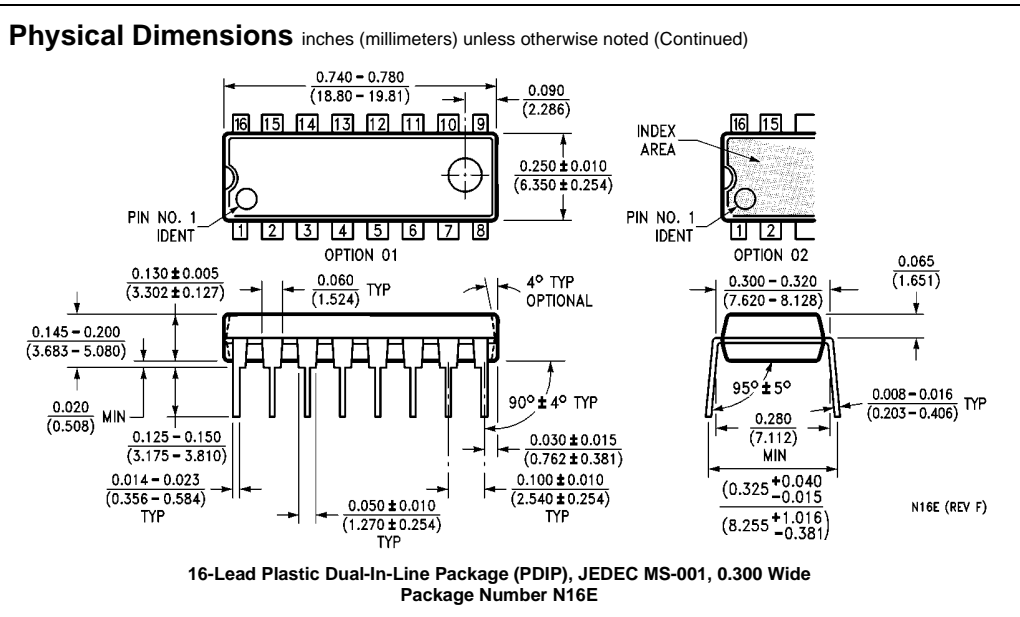

Fairchild does not assume any responsibility for use of any circuitry described, no circuit patent licenses are implied and Fairchild reserves the right at any time without notice to change said circuitry and specifications.

**LIFE SUPPORT POLICY**

FAIRCHILD'S PRODUCTS ARE NOT AUTHORIZED FOR USE AS CRITICAL COMPONENTS IN LIFE SUPPORT DEVICES OR SYSTEMS WITHOUT THE EXPRESS WRITTEN APPROVAL OF THE PRESIDENT OF FAIRCHILD SEMICONDUCTOR CORPORATION. As used herein:

1. Life support devices or systems are devices or systems which, (a) are intended for surgical implant into the body, or (b) support or sustain life, and (c) whose failure to perform when properly used in accordance with instructions for use provided in the labeling, can be reasonably expected to result in a significant injury to the user.
2. A critical component in any component of a life support device or system whose failure to perform can be reasonably expected to cause the failure of the life support device or system, or to affect its safety or effectiveness.

[www.fairchildsemi.com](http://www.fairchildsemi.com)