

74F253 Dual 4-Input Multiplexer with 3-STATE Outputs

General Description

The 74F253 is a dual 4-input multiplexer with 3-STATE outputs. It can select two bits of data from four sources using common select inputs. The output may be individually switched to a high impedance state with a HIGH on the respective Output Enable (OE) inputs, allowing the outputs to interface directly with bus oriented systems.

Features

- Multifunction capability
- Non-inverting 3-STATE outputs

Ordering Code:

Order Number	Package Number	Package Description
74F253SC	M16A	16-Lead Small Outline Integrated Circuit (SOIC), JEDEC MS-012, 0.150 Narrow
74F253SJ	M16D	16-Lead Small Outline Package (SOP), EIAJ TYPE II, 5.3mm Wide
74F253PC	N16E	16-Lead Plastic Dual-In-Line Package (PDIP), JEDEC MS-001, 0.300 Wide

Devices also available in Tape and Reel. Specify by appending the suffix letter "X" to the ordering code.

Logic Symbols

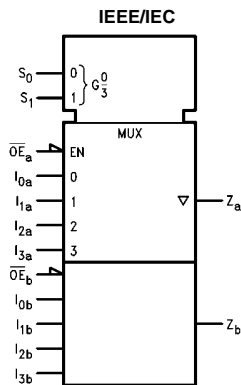
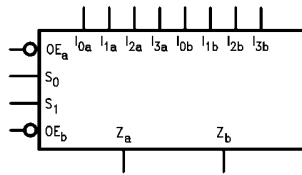

Connection Diagram

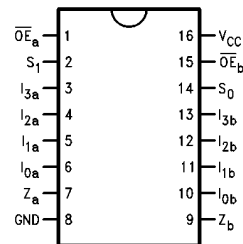

Unit Loading/Fan Out

Pin Names	Description	U.L. HIGH/LOW	Input I_{IH}/I_{IL} Output I_{OH}/I_{OL}
$I_{0a}-I_{3a}$	Side A Data Inputs	1.0/1.0	20 μ A/-0.6 mA
$I_{0b}-I_{3b}$	Side B Data Inputs	1.0/1.0	20 μ A/-0.6 mA
S_0-S_1	Common Select Inputs	1.0/1.0	20 μ A/-0.6 mA
\overline{OE}_a	Side A Output Enable Input (Active LOW)	1.0/1.0	20 μ A/-0.6 mA
\overline{OE}_b	Side B Output Enable Input (Active LOW)	1.0/1.0	20 μ A/-0.6 mA
Z_a, Z_b	3-STATE Outputs	150/40(33.3)	-3 mA/24 mA (20 mA)

Functional Description

This device contains two identical 4-input multiplexers with 3-STATE outputs. They select two bits from four sources selected by common Select inputs (S_0, S_1). The 4-input multiplexers have individual Output Enable ($\overline{OE}_a, \overline{OE}_b$) inputs which, when HIGH, force the outputs to a high impedance (High Z) state. This device is the logic implementation of a 2-pole, 4-position switch, where the position of the switch is determined by the logic levels supplied to the two select inputs. The logic equations for the outputs are shown below:

$$Z_a = \overline{OE}_a \cdot (I_{0a} \cdot \overline{S}_1 \cdot \overline{S}_0 + I_{1a} \cdot \overline{S}_1 \cdot S_0 + I_{2a} \cdot S_1 \cdot \overline{S}_0 + I_{3a} \cdot S_1 \cdot S_0)$$

$$Z_b = \overline{OE}_b \cdot (I_{0b} \cdot \overline{S}_1 \cdot \overline{S}_0 + I_{1b} \cdot \overline{S}_1 \cdot S_0 + I_{2b} \cdot S_1 \cdot \overline{S}_0 + I_{3b} \cdot S_1 \cdot S_0)$$

If the outputs of 3-STATE devices are tied together, all but one device must be in the high impedance state to avoid high currents that would exceed the maximum ratings. Designers should ensure that Output Enable signals to 3-STATE devices whose outputs are tied together are designed so that there is no overlap.

Truth Table

Select Inputs		Data Inputs				Output Enable	Output
S_0	S_1	I_0	I_1	I_2	I_3	\overline{OE}	\overline{Z}
X	X	X	X	X	X	H	Z
L	L	L	X	X	X	L	L
L	L	H	X	X	X	L	H
H	L	X	L	X	X	L	L
H	L	X	H	X	X	L	H
L	H	X	X	L	X	L	L
L	H	X	X	H	X	L	H
H	H	X	X	X	L	L	L
H	H	X	X	X	H	L	H

Address inputs S_0 and S_1 are common to both sections.

H = HIGH Voltage Level
L = LOW Voltage Level
X = Immaterial
Z = High Impedance

Logic Diagram

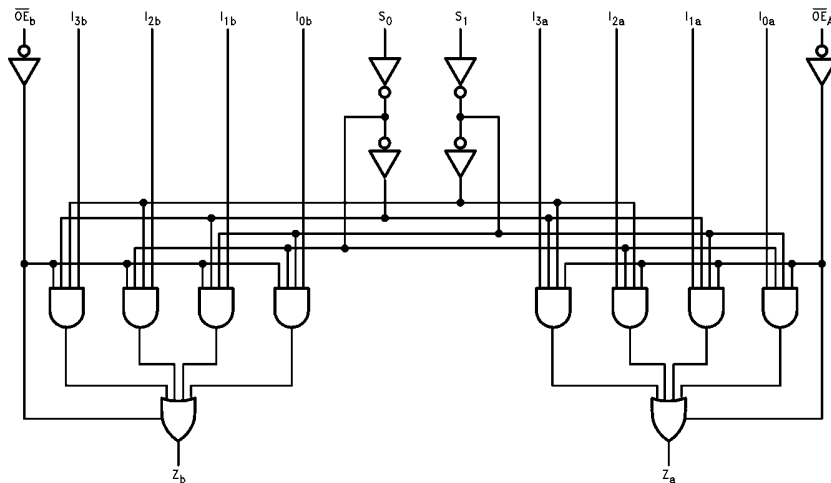

Please note that this diagram is provided only for the understanding of logic operations and should not be used to estimate propagation delays.

Absolute Maximum Ratings(Note 1)

Storage Temperature	-65°C to +150°C
Ambient Temperature under Bias	-55°C to +125°C
Junction Temperature under Bias	-55°C to +150°C
V _{CC} Pin Potential to Ground Pin	-0.5V to +7.0V
Input Voltage (Note 2)	-0.5V to +7.0V
Input Current (Note 2)	-30 mA to +5.0 mA
Voltage Applied to Output in HIGH State (with V _{CC} = 0V)	
Standard Output	-0.5V to V _{CC}
3-STATE Output	-0.5V to +5.5V
Current Applied to Output in LOW State (Max)	twice the rated I _{OL} (mA)
ESD Last Passing Voltage (Min)	4000V

Recommended Operating Conditions

Free Air Ambient Temperature	0°C to +70°C
Supply Voltage	+4.5V to +5.5V

Note 1: Absolute maximum ratings are values beyond which the device may be damaged or have its useful life impaired. Functional operation under these conditions is not implied.

Note 2: Either voltage limit or current limit is sufficient to protect inputs.

DC Electrical Characteristics

Symbol	Parameter	Min	Typ	Max	Units	V _{CC}	Conditions
V _{IH}	Input HIGH Voltage	2.0			V		Recognized as a HIGH Signal
V _{IL}	Input LOW Voltage			0.8	V		Recognized as a LOW Signal
V _{CD}	Input Clamp Diode Voltage			-1.2	V	Min	I _{IN} = -18 mA
V _{OH}	Output HIGH Voltage	10% V _{CC}	2.5		V	Min	I _{OH} = -1 mA
		10% V _{CC}	2.4	I _{OH} = -3 mA			
		5% V _{CC}	2.7	I _{OH} = -1 mA			
		5% V _{CC}	2.7	I _{OH} = -3 mA			
V _{OL}	Output LOW Voltage			0.5	V	Min	I _{OL} = 24 mA
I _{IH}	Input HIGH Current			5.0	μA	Max	V _{IN} = 2.7V
I _{BVI}	Input HIGH Current Breakdown Test			7.0	μA	Max	V _{IN} = 7.0V
I _{CEX}	Output HIGH Leakage Current			50	μA	Max	V _{OUT} = V _{CC}
V _{ID}	Input Leakage Test	4.75			V	0.0	I _{ID} = 1.9 μA All Other Pins Grounded
I _{OD}	Output Leakage Circuit Current			3.75	μA	0.0	V _{IOD} = 150 mV All Other Pins Grounded
I _{IL}	Input LOW Current			-0.6	mA	Max	V _{IN} = 0.5V
I _{OZH}	Output Leakage Current			50	μA	Max	V _{OUT} = 2.7V
I _{OZL}	Output Leakage Current			-50	μA	Max	V _{OUT} = 0.5V
I _{OS}	Output Short-Circuit Current			-60	mA	Max	V _{OUT} = 0V
				-100			V _{OUT} = 0V
I _{ZZ}	Bus Drainage Test			500	μA	0.0V	V _{OUT} = V _{CC}
I _{CCH}	Power Supply Current		11.5	16	mA	Max	V _O = HIGH
I _{CCL}	Power Supply Current		16	23	mA	Max	V _O = LOW
I _{CCZ}	Power Supply Current		16	23	mA	Max	V _O = HIGH Z

AC Electrical Characteristics									
Symbol	Parameter	T _A = +25°C V _{CC} = 5.0V C _L = 50 pF			T _A = -55°C to +125°C V _{CC} = 5.0V C _L = 50 pF		T _A = 0°C to +70°C V _{CC} = 5.0V C _L = 50 pF		Units
		Min	Typ	Max	Min	Max	Min	Max	
t _{PLH}	Propagation Delay	4.5	8.5	11.5	3.5	15.0	4.5	13.0	ns
t _{PHL}	S _n to Z _n	3.0	6.5	9.0	2.5	11.0	3.0	10.0	
t _{PLH}	Propagation Delay	3.0	5.5	7.0	2.5	9.0	3.0	8.0	ns
t _{PHL}	I _n to Z _n	2.5	4.5	6.0	2.5	8.0	2.5	7.0	
t _{PZH}	Output Enable Time	3.0	6.0	8.0	2.5	10.0	3.0	9.0	ns
t _{PZL}		3.0	6.0	8.0	2.5	10.0	3.0	9.0	
t _{PHZ}	Output Disable Time	2.0	3.7	5.0	2.0	6.5	2.0	6.0	
t _{PLZ}		2.0	4.4	6.0	2.0	8.0	2.0	7.0	

Physical Dimensions inches (millimeters) unless otherwise noted

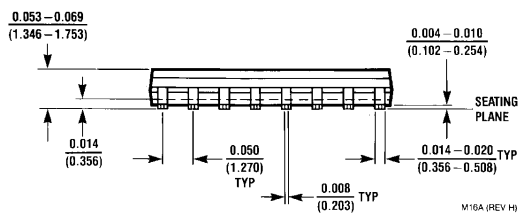
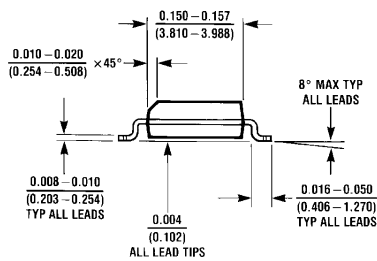
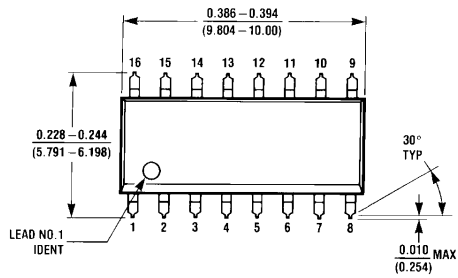

16-Lead Small Outline Integrated Circuit (SOIC), JEDEC MS-012, 0.150 Narrow Package Number M16A

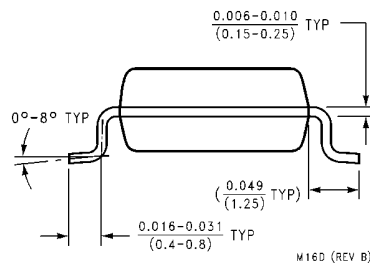
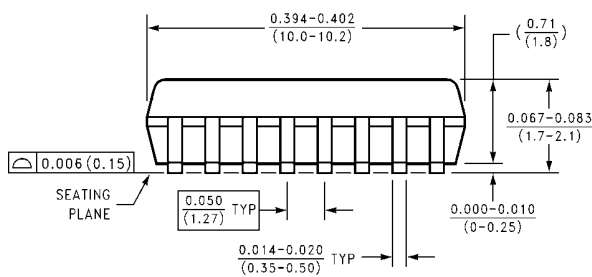
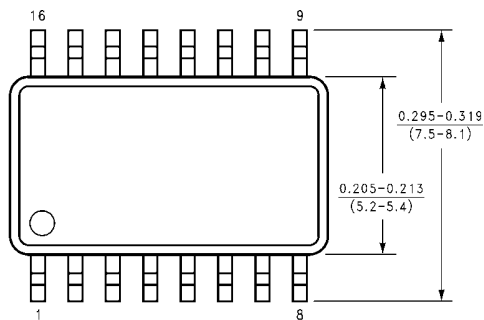

16-Lead Small Outline Package (SOP), EIAJ TYPE II, 5.3mm Wide Package Number M16D

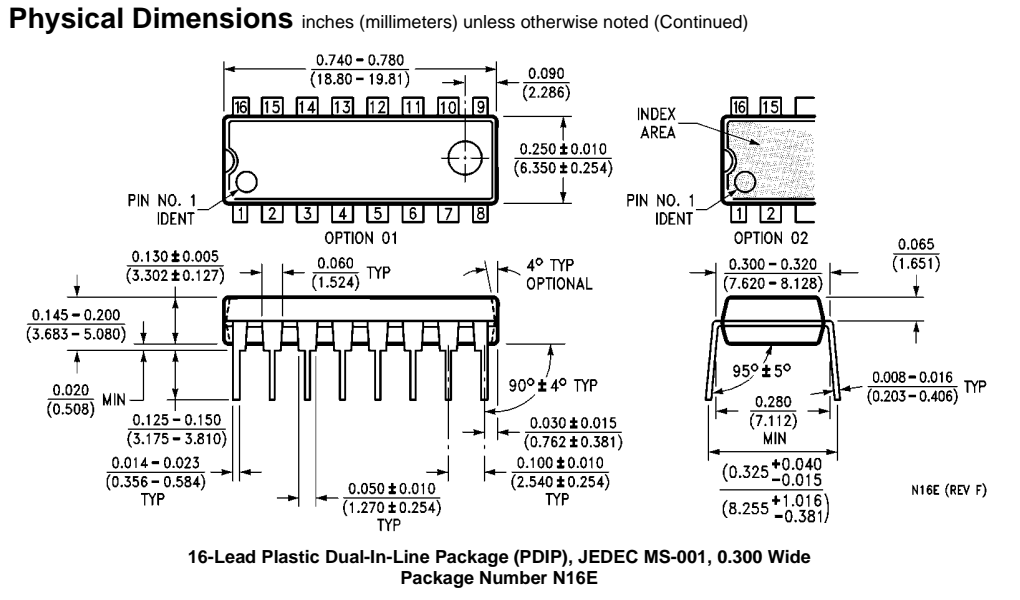

Fairchild does not assume any responsibility for use of any circuitry described, no circuit patent licenses are implied and Fairchild reserves the right at any time without notice to change said circuitry and specifications.

LIFE SUPPORT POLICY

FAIRCHILD'S PRODUCTS ARE NOT AUTHORIZED FOR USE AS CRITICAL COMPONENTS IN LIFE SUPPORT DEVICES OR SYSTEMS WITHOUT THE EXPRESS WRITTEN APPROVAL OF THE PRESIDENT OF FAIRCHILD SEMICONDUCTOR CORPORATION. As used herein:

1. Life support devices or systems are devices or systems which, (a) are intended for surgical implant into the body, or (b) support or sustain life, and (c) whose failure to perform when properly used in accordance with instructions for use provided in the labeling, can be reasonably expected to result in a significant injury to the user.
2. A critical component in any component of a life support device or system whose failure to perform can be reasonably expected to cause the failure of the life support device or system, or to affect its safety or effectiveness.

www.fairchildsemi.com