

74F257A Quad 2-Input Multiplexer with 3-STATE Outputs

General Description

The 74F257A is a quad 2-input multiplexer with 3-STATE outputs. Four bits of data from two sources can be selected using a Common Data Select input. The four outputs present the selected data in true (non-inverted) form. The outputs may be switched to a high impedance state with a HIGH on the common Output Enable (\overline{OE}) input, allowing the outputs to interface directly with bus-oriented systems.

Features

- Multiplexer expansion by tying outputs together
- Non-inverting 3-STATE outputs
- Input clamp diodes limit high-speed termination effects

Ordering Code:

Order Number	Package Number	Package Description
74F257ASC	M16A	16-Lead Small Outline Integrated Circuit (SOIC), JEDEC MS-012, 0.150 Narrow
74F257ASJ	M16D	16-Lead Small Outline Package (SOP), EIAJ TYPE II, 5.3mm Wide
74F257APC	N16E	16-Lead Plastic Dual-In-Line Package (PDIP), JEDEC MS-001, 0.300 Wide

Devices also available in Tape and Reel. Specify by appending the suffix letter "X" to the ordering code.

Logic Symbols

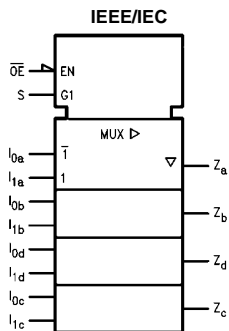
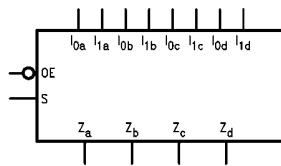

Connection Diagram

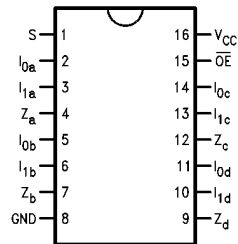

Unit Loading/Fan Out

Pin Names	Description	U.L. HIGH/LOW	Input I_{IH}/I_{IL} Output I_{OH}/I_{OL}
S	Common Data Select Input	1.0/1.0	20 μ A/-0.6 mA
\overline{OE}	3-STATE Output Enable Input (Active LOW)	1.0/1.0	20 μ A/-0.6 mA
$I_{0a}-I_{0d}$	Data Inputs from Source 0	1.0/1.0	20 μ A/-0.6 mA
$I_{1a}-I_{1d}$	Data Inputs from Source 1	1.0/1.0	20 μ A/-0.6 mA
Z_a-Z_d	3-STATE Multiplexer Outputs	150/40 (33.3)	-3 mA/24 mA (20 mA)

Truth Table

Output Enable	Select Input	Data Inputs		Output
\overline{OE}	S	I_0	I_1	Z
H	X	X	X	Z
L	H	X	L	L
L	H	X	H	H
L	L	L	X	L
L	L	H	X	H

H = HIGH Voltage Level
L = LOW Voltage Level
X = Immaterial
Z = High Impedance

Functional Description

The 74F257A is a quad 2-input multiplexer with 3-STATE outputs. It selects four bits of data from two sources under control of a Common Data Select input. When the Select input is LOW, the I_{0x} inputs are selected and when Select is HIGH, the I_{1x} inputs are selected. The data on the selected inputs appears at the outputs in true (non-inverted) form. The device is the logic implementation of a 4-pole, 2-position switch where the position of the switch is determined by the logic levels supplied to the Select input. The logic equation for the outputs is shown below:

$$Z_n = \overline{OE} \cdot (I_n \cdot S + I_{on} \cdot \overline{S})$$

When the Output Enable input (\overline{OE}) is HIGH, the outputs are forced to a high impedance OFF state. If the outputs are tied together, all but one device must be in the high impedance state to avoid high currents that would exceed the maximum ratings. Designers should ensure the Output Enable signals to 3-STATE devices whose outputs are tied together are designed so there is no overlap.

Logic Diagram

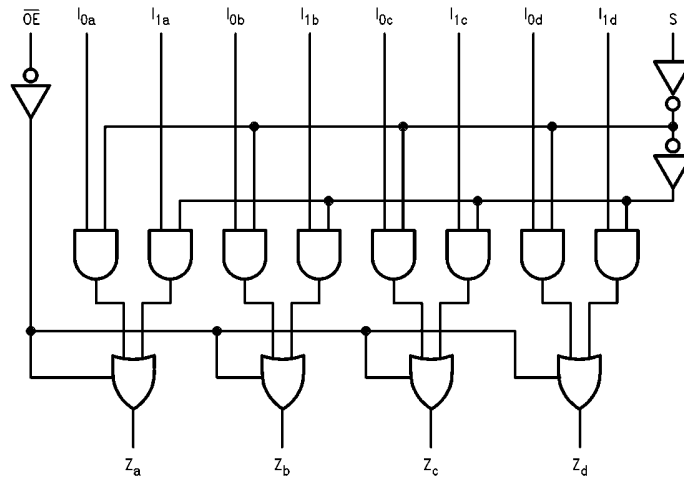

Please note that this diagram is provided only for the understanding of logic operations and should not be used to estimate propagation delays.

Absolute Maximum Ratings ^(Note 1)		Recommended Operating Conditions	
Storage Temperature	-65°C to +150°C	Free Air Ambient Temperature	0°C to +70°C
Ambient Temperature under Bias	-55°C to +125°C	Supply Voltage	+4.5V to +5.5V
Junction Temperature under Bias	-55°C to +150°C		
V _{CC} Pin Potential to Ground Pin	-0.5V to +7.0V		
Input Voltage (Note 2)	-0.5V to +7.0V		
Input Current (Note 2)	-30 mA to +5.0 mA		
Voltage Applied to Output in HIGH State (with V _{CC} = 0V)			
Standard Output	-0.5V to V _{CC}		
3-STATE Output	-0.5V to +5.5V		
Current Applied to Output in LOW State (Max)	twice the rated I _{OL} (mA)		
ESD Last Passing Voltage (Min)	4000V		

Note 1: Absolute maximum ratings are values beyond which the device may be damaged or have its useful life impaired. Functional operation under these conditions is not implied.

Note 2: Either voltage limit or current limit is sufficient to protect inputs.

DC Electrical Characteristics

Symbol	Parameter	Min	Typ	Max	Units	V _{CC}	Conditions
V _{IH}	Input HIGH Voltage	2.0			V		Recognized as a HIGH Signal
V _{IL}	Input LOW Voltage			0.8	V		Recognized as a LOW Signal
V _{CD}	Input Clamp Diode Voltage			-1.2	V	Min	I _{IN} = -18 mA
V _{OH}	Output HIGH Voltage	10% V _{CC} 2.5 10% V _{CC} 2.4 5% V _{CC} 2.7 5% V _{CC} 2.7			V	Min	I _{OH} = -1 mA I _{OH} = -3 mA I _{OH} = -1 mA I _{OH} = -3 mA
V _{OL}	Output LOW Voltage	10% V _{CC}		0.5	V	Min	I _{OL} = 24 mA
I _{IH}	Input HIGH Current			5.0	μA	Max	V _{IN} = 2.7V
I _{BVI}	Input HIGH Current Breakdown Test			7.0	μA	Max	V _{IN} = 7.0V
I _{CEX}	Output HIGH Leakage Current			50	μA	Max	V _{OUT} = V _{CC}
V _{ID}	Input Leakage Test	4.75			V	0.0	I _{ID} = 1.9 μA All Other Pins Grounded
I _{OD}	Output Leakage Circuit Current			3.75	μA	0.0	V _{IOD} = 150 mV All Other Pins Grounded
I _{IL}	Input LOW Current			-0.6	mA	Max	V _{IN} = 0.5V
I _{OZH}	Output Leakage Current			50	μA	Max	V _{OUT} = 2.7V
I _{OZL}	Output Leakage Current			-50	μA	Max	V _{OUT} = 0.5V
I _{OS}	Output Short-Circuit Current	-60		-150	mA	Max	V _{OUT} = 0V
I _{ZZ}	Bus Drainage Test			500	μA	0.0V	V _{OUT} = 5.25V
I _{CCH}	Power Supply Current		9.0	15	mA	Max	V _O = HIGH
I _{CCL}	Power Supply Current		14.5	22	mA	Max	V _O = LOW
I _{CCZ}	Power Supply Current		15	23	mA	Max	V _O = HIGH Z

AC Electrical Characteristics									
Symbol	Parameter	T _A = +25°C V _{CC} = 5.0V C _L = 50 pF			T _A = -55°C to +125°C V _{CC} = 5.0V C _L = 50 pF		T _A = 0°C to +70°C V _{CC} = 5.0V C _L = 50 pF		Units
		Min	Typ	Max	Min	Max	Min	Max	
t _{PLH}	Propagation Delay	2.5	4.5	5.5	2.0	7.0	2.0	6.0	ns
t _{PHL}	I _n to Z _n	2.0	4.2	5.5	1.5	7.0	2.0	6.0	
t _{PLH}	Propagation Delay	4.0	5.0	9.5	3.5	11.5	3.5	10.5	ns
t _{PHL}	S to Z _n	2.5	6.5	7.0	2.5	9.0	2.5	8.0	
t _{PZH}	Output Enable Time	2.0	5.9	6.0	2.0	8.0	2.0	7.0	ns
t _{PZL}		2.5	5.5	7.0	2.5	9.0	2.5	8.0	
t _{PHZ}	Output Disable Time	2.0	4.3	6.0	2.0	7.0	2.0	7.0	
t _{PLZ}		2.0	4.5	6.0	2.0	8.5	2.0	7.0	

Physical Dimensions inches (millimeters) unless otherwise noted

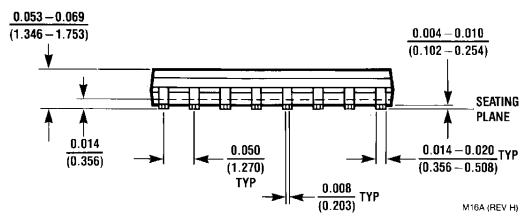
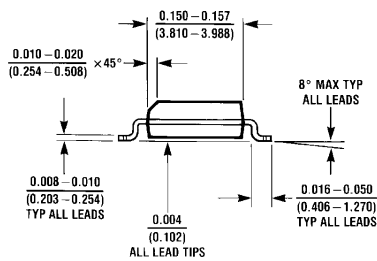
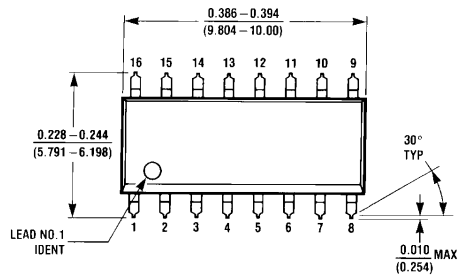

16-Lead Small Outline Integrated Circuit (SOIC), JEDEC MS-012, 0.150 Narrow Package Number M16A

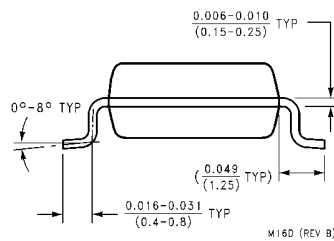
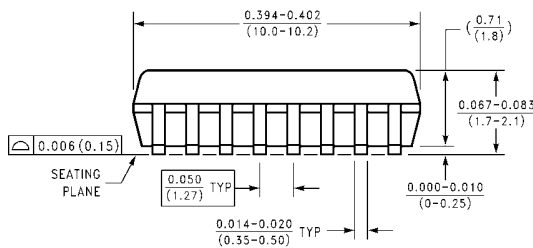
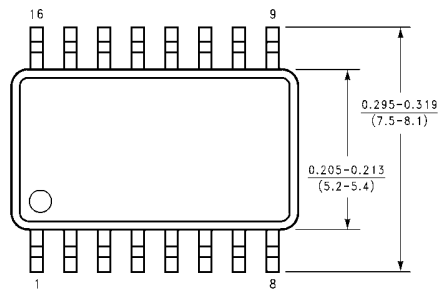

16-Lead Small Outline Package (SOP), EIAJ TYPE II, 5.3mm Wide Package Number M16D

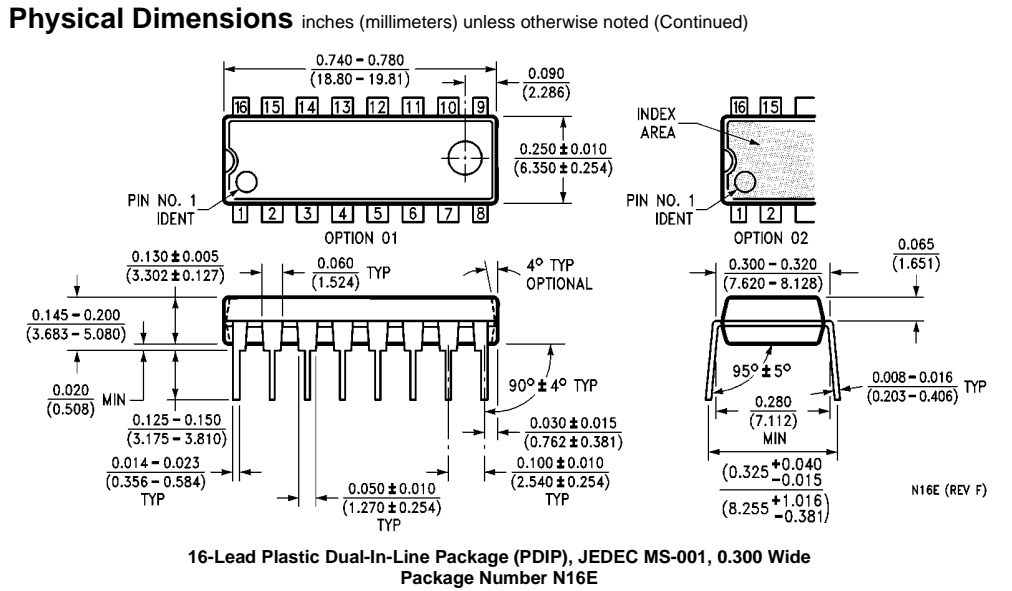

Fairchild does not assume any responsibility for use of any circuitry described, no circuit patent licenses are implied and Fairchild reserves the right at any time without notice to change said circuitry and specifications.

LIFE SUPPORT POLICY

FAIRCHILD'S PRODUCTS ARE NOT AUTHORIZED FOR USE AS CRITICAL COMPONENTS IN LIFE SUPPORT DEVICES OR SYSTEMS WITHOUT THE EXPRESS WRITTEN APPROVAL OF THE PRESIDENT OF FAIRCHILD SEMICONDUCTOR CORPORATION. As used herein:

1. Life support devices or systems are devices or systems which, (a) are intended for surgical implant into the body, or (b) support or sustain life, and (c) whose failure to perform when properly used in accordance with instructions for use provided in the labeling, can be reasonably expected to result in a significant injury to the user.
2. A critical component in any component of a life support device or system whose failure to perform can be reasonably expected to cause the failure of the life support device or system, or to affect its safety or effectiveness.

www.fairchildsemi.com