

## 74F366•74F368 Hex Inverter Buffer with 3-STATE Outputs

### Features

- 3-STATE buffer outputs sink 64 mA
- High-speed
- Bus-oriented
- High impedance npn base inputs for reduced loading

### Ordering Code:

Order Number	Package Number	Package Description
74F366SC	M16A	16-Lead Small Outline Integrated Circuit (SOIC), JEDEC MS-012, 0.150 Narrow
74F366PC	N16E	16-Lead Plastic Dual-In-Line Package (PDIP), JEDEC MS-001, 0.300 Wide
74F368SC	M16A	16-Lead Small Outline Integrated Circuit (SOIC), JEDEC MS-012, 0.150 Narrow
74F368SJ	M16D	16-Lead Small Outline Package (SOP), EIAJ TYPE II, 5.3mm Wide
74F368PC	N16E	16-Lead Plastic Dual-In-Line Package (PDIP), JEDEC MS-001, 0.300 Wide

Devices also available in Tape and Reel. Specify by appending the suffix letter "X" to the ordering code.

### Connection Diagrams

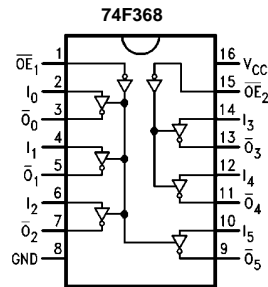
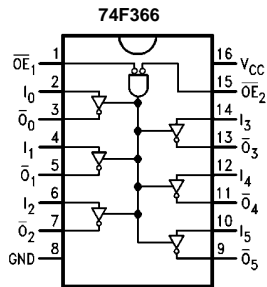

### Logic Symbols

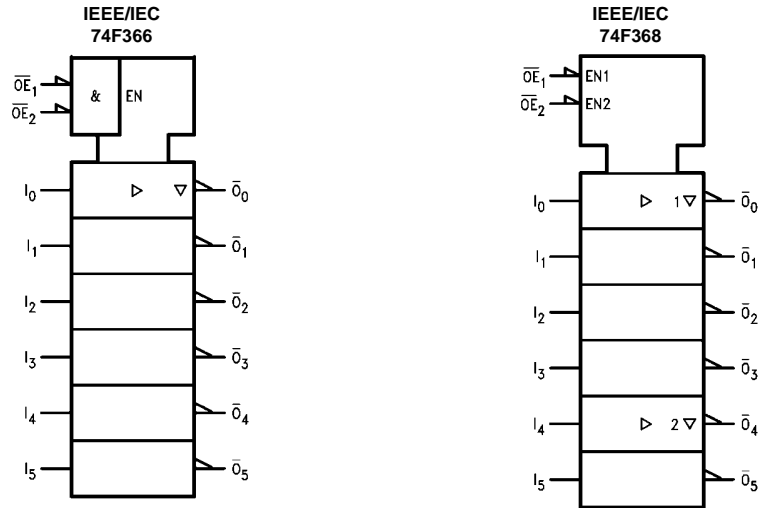

### Unit Loading/Fan Out

Pin Names	Description	U.L. HIGH/LOW	Input $I_{IH}/I_{IL}$ Output $I_{OH}/I_{OL}$
$\overline{OE}_1, \overline{OE}_2$	Output Enable Input (Active LOW)	1.0/0.033	20 $\mu$ A/-20 $\mu$ A
$I_n$	Input	1.0/0.033	20 $\mu$ A/-20 $\mu$ A
$O_n, \overline{O}_n$	Outputs	600/106.6 (80)	-12 mA/64 mA (48 mA)

### Function Tables

**74F366**

Inputs			Output
$\overline{OE}_1$	$\overline{OE}_2$	I	$\overline{O}$
L	L	L	H
L	L	H	L
X	H	X	Z
H	X	X	Z

**74F368**

Inputs		Output
$\overline{OE}$	I	$\overline{O}$
L	L	H
L	H	L
H	X	Z

L = LOW Voltage Level    X = Immaterial  
H = HIGH Voltage Level    Z = High Impedance

**Absolute Maximum Ratings**(Note 1)

Storage Temperature	-65°C to +150°C
Ambient Temperature under Bias	-55°C to +125°C
Junction Temperature under Bias	-55°C to +150°C
V <sub>CC</sub> Pin Potential to Ground Pin	-0.5V to +7.0V
Input Voltage (Note 2)	-0.5V to +7.0V
Input Current (Note 2)	-30 mA to +5.0 mA
Voltage Applied to Output	
in HIGH State (with V <sub>CC</sub> = 0V)	
Standard Output	-0.5V to V <sub>CC</sub>
3-STATE Output	-0.5V to +5.5V
Current Applied to Output	
in LOW State (Max)	twice the rated I <sub>OL</sub> (mA)

**Recommended Operating Conditions**

Free Air Ambient Temperature	0°C to +70°C
Supply Voltage	+4.5V to +5.5V

**Note 1:** Absolute maximum ratings are values beyond which the device may be damaged or have its useful life impaired. Functional operation under these conditions is not implied.

**Note 2:** Either voltage limit or current limit is sufficient to protect inputs.

**DC Electrical Characteristics**

Symbol	Parameter	Min	Typ	Max	Units	V <sub>CC</sub>	Conditions
V <sub>IH</sub>	Input HIGH Voltage	2.0			V		Recognized as a HIGH Signal
V <sub>IL</sub>	Input LOW Voltage			0.8	V		Recognized as a LOW Signal
V <sub>CD</sub>	Input Clamp Diode Voltage			-1.2	V	Min	I <sub>IN</sub> = -18 mA
V <sub>OH</sub>	Output HIGH Voltage 10% V <sub>CC</sub>	2.0			V	Min	I <sub>OH</sub> = -15 mA
V <sub>OL</sub>	Output LOW Voltage 10% V <sub>CC</sub>			0.55	V	Min	I <sub>OL</sub> = 64 mA
I <sub>IH</sub>	Input HIGH Current			20	μA	Max	V <sub>IN</sub> = 2.7V
I <sub>BVI</sub>	Input HIGH Current Breakdown Test			100	μA	Max	V <sub>IN</sub> = 7.0V
I <sub>IL</sub>	Input LOW Current			-20	μA	Max	V <sub>IN</sub> = 0.5V
I <sub>OZH</sub>	Output Leakage Current			50	μA	Max	V <sub>OUT</sub> = 2.7V
I <sub>OZL</sub>	Output Leakage Current			-50	μA	Max	V <sub>OUT</sub> = 0.5V
I <sub>OS</sub>	Output Short-Circuit Current	-100		-225	mA	Max	V <sub>OUT</sub> = 0V
I <sub>CEX</sub>	Output HIGH Leakage Current			250	μA	Max	V <sub>OUT</sub> = V <sub>CC</sub>
I <sub>ZZ</sub>	Bus Drainage Test			500	μA	0.0V	V <sub>OUT</sub> = 5.25V
I <sub>CCH</sub>	Power Supply Current		20	25	mA	Max	V <sub>O</sub> = HIGH
I <sub>CCL</sub>	Power Supply Current		49	62	mA	Max	V <sub>O</sub> = LOW
I <sub>CCZ</sub>	Power Supply Current		35	48	mA	Max	V <sub>O</sub> = HIGH Z

**AC Electrical Characteristics**

Symbol	Parameter	T <sub>A</sub> = +25°C V <sub>CC</sub> = +5.0V C <sub>L</sub> = 50 pF			T <sub>A</sub> = 0°C to +70°C C <sub>L</sub> = 50 pF C <sub>L</sub> = 50 pF		Units
		Min	Typ	Max	Min	Max	
t <sub>PLH</sub>	Propagation Delay	2.5	4.0	6.5	2.0	7.5	ns
t <sub>PHL</sub>		1.0	1.8	5.0	1.0	5.5	
t <sub>PZH</sub>	Enable Time (74F366)	2.5	4.2	9.5	2.5	10.0	ns
t <sub>PZL</sub>		2.5	4.2	9.0	2.5	9.5	
t <sub>PZH</sub>	Enable Time (74F368)	2.5	4.2	7.5	2.0	8.5	ns
t <sub>PZL</sub>		3.0	5.6	8.5	3.0	9.0	
t <sub>PHZ</sub>	Disable Time	2.0	3.3	6.5	2.0	7.0	ns
t <sub>PLZ</sub>		2.0	4.1	6.5	2.0	7.0	

**Physical Dimensions** inches (millimeters) unless otherwise noted

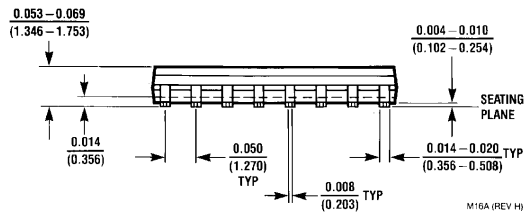
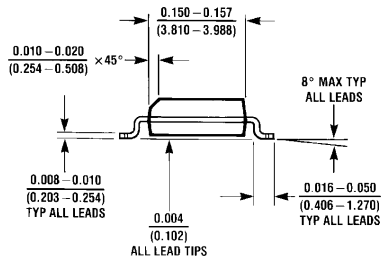
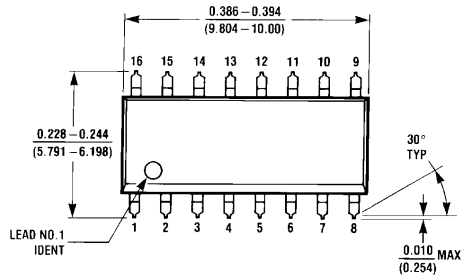

**16-Lead Small Outline Integrated Circuit (SOIC), JEDEC MS-012, 0.150 Narrow Package Number M16A**

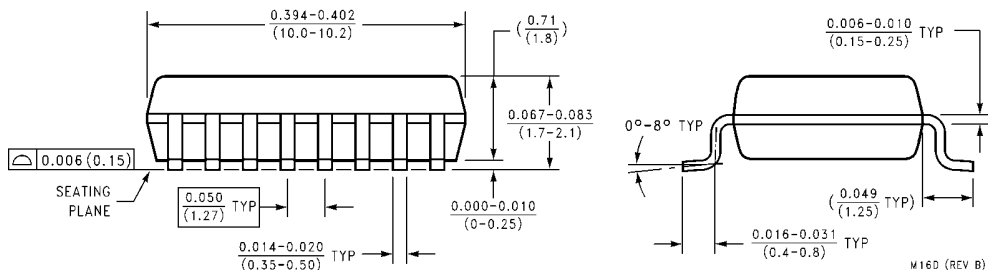
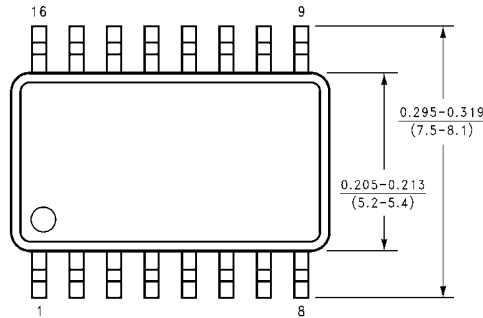

**16-Lead Small Outline Package (SOP), EIAJ TYPE II, 5.3mm Wide Package Number M16D**

