

## 74LVQ245 Low Voltage Octal Bidirectional Transceiver with 3-STATE Outputs

### General Description

The LVQ245 contains eight non-inverting bidirectional buffers with 3-STATE outputs and is intended for bus-oriented applications. Current sinking capability is 12 mA at both the A and B ports. The Transmit/Receive (T/R) input determines the direction of data flow through the bidirectional transceiver. Transmit (active-HIGH) enables data from A ports to B ports; Receive (active-LOW) enables data from B ports to A ports. The Output Enable input, when HIGH, disables both A and B ports by placing them in a HIGH Z condition.

### Features

- Ideal for low power/low noise 3.3V applications
- Implements patented EMI reduction circuitry
- Available in SOIC JEDEC, SOIC EIAJ and QSOP packages
- Guaranteed simultaneous switching noise level and dynamic threshold performance
- Improved latch-up immunity
- Guaranteed incident wave switching into 75Ω
- 4 kV minimum ESD immunity

### Ordering Code

Order Number	Package Number	Package Description
74LVQ245SC	M20B	20-Lead (0.300" Wide) Small Outline Package, SOIC JEDEC
74LVQ245SJ	M20D	20-Lead Molded Shrink Small Outline Package, SOIC EIAJ
74LVQ245QSC	MQA20	20-Lead (0.150" Wide) Molded Shrink Small Outline Package, SSOP JEDEC

Devices also available in Tape and Reel. Specify by appending suffix letter "X" to the ordering code.

### Logic Symbols

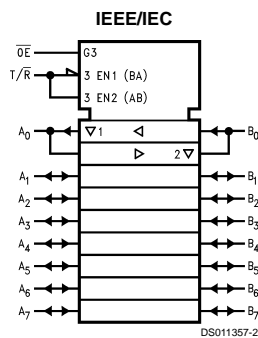
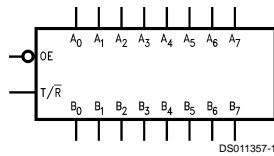

### Connection Diagram

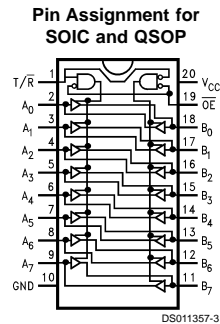

## Pin Descriptions

Pin Names	Description
$\overline{OE}$	Output Enable Inputs
$T/\overline{R}$	Transmit/Receive Input
$A_0-A_7$	Side A Inputs or 3-STATE Outputs
$B_0-B_7$	Side B Inputs or 3-STATE Outputs

## Truth Table

Inputs		Outputs
$\overline{OE}$	$T/\overline{R}$	
L	L	Bus B Data to Bus A
L	H	Bus A Data to Bus B
H	X	HIGH-Z State

H = HIGH Voltage Level  
L = LOW Voltage Level  
X = Immaterial

## Absolute Maximum Ratings (Note 1)

Supply Voltage ( $V_{CC}$ )	-0.5V to +7.0V
DC Input Diode Current ( $I_{IK}$ )	
$V_I = -0.5V$	-20 mA
$V_I = V_{CC} + 0.5V$	+20 mA
DC Input Voltage ( $V_I$ )	-0.5V to $V_{CC} + 0.5V$
DC Output Diode Current ( $I_{OK}$ )	
$V_O = -0.5V$	-20 mA
$V_O = V_{CC} + 0.5V$	+20 mA
DC Output Voltage ( $V_O$ )	-0.5V to $V_{CC} + 0.5V$
DC Output Source or Sink Current ( $I_O$ )	±50 mA
DC $V_{CC}$ or Ground Current ( $I_{CC}$ or $I_{GND}$ )	±400 mA
Storage Temperature ( $T_{STG}$ )	-65°C to +150°C
DC Latch-Up Source or Sink Current	±300 mA

## Recommended Operating Conditions (Note 2)

Supply Voltage ( $V_{CC}$ )	2.0V to 3.6V
Input Voltage ( $V_I$ )	0V to $V_{CC}$
Output Voltage ( $V_O$ )	0V to $V_{CC}$
Operating Temperature ( $T_A$ )	-40°C to +85°C
Minimum Input Edge Rate ( $\Delta V/\Delta t$ )	
$V_{IN}$ from 0.8V to 2.0V	
$V_{CC}$ @ 3.0V	125 mV/ ns

**Note 1:** The "Absolute Maximum Ratings" are those values beyond which the safety of the device cannot be guaranteed. The device should not be operated at these limits. The parametric values defined in the Electrical Characteristics tables are not guaranteed at the absolute maximum ratings. The "Recommended Operating Conditions" table will define the conditions for actual device operation.

**Note 2:** Unused inputs must be held HIGH or LOW. They may not float.

## DC Electrical Characteristics

Symbol	Parameter	$V_{CC}$ (V)	$T_A = +25^\circ\text{C}$		$T_A = -40^\circ\text{C to } +85^\circ\text{C}$	Units	Conditions
			Typ	Guaranteed Limits			
$V_{IH}$	Minimum High Level Input Voltage	3.0	1.5	2.0	2.0	V	$V_{OUT} = 0.1V$ or $V_{CC} - 0.1V$
$V_{IL}$	Maximum Low Level Input Voltage	3.0	1.5	0.8	0.8	V	$V_{OUT} = 0.1V$ or $V_{CC} - 0.1V$
$V_{OH}$	Minimum High Level Output Voltage	3.0	2.99	2.9	2.9	V	$I_{OUT} = -50 \mu\text{A}$
		3.0		2.58	2.48	V	$V_{IN} = V_{IL}$ or $V_{IH}$ (Note 3) $I_{OH} = -12 \text{ mA}$
$V_{OL}$	Maximum Low Level Output Voltage	3.0	0.002	0.1	0.1	V	$I_{OUT} = 50 \mu\text{A}$
		3.0		0.36	0.44	V	$V_{IN} = V_{IL}$ or $V_{IH}$ (Note 3) $I_{OL} = +12 \text{ mA}$
$I_{IN}$	Maximum Input Leakage Current	3.6		±0.1	±1.0	μA	$V_I = V_{CC}, \text{ GND}$
$I_{OLD}$	Minimum Dynamic Output Current (Note 4)	3.6			36	mA	$V_{OLD} = 0.8V \text{ Max}$ (Note 5)
$I_{OHD}$		3.6			-25	mA	$V_{OHD} = 2.0V \text{ Min}$ (Note 5)
$I_{CC}$	Maximum Quiescent Supply Current	3.6		4.0	40.0	μA	$V_{IN} = V_{CC}$ or GND
$I_{OZT}$	Maximum I/O Leakage Current	3.6		±0.3	±3.0	μA	$V_I (\text{OE}) = V_{IL}, V_{IH}$ $V_I = V_{CC}, \text{ GND}$ $V_O = V_{CC}, \text{ GND}$ (Notes 6, 7)
$V_{OLP}$	Quiet Output Maximum Dynamic $V_{OL}$	3.3	0.5	0.8		V	(Notes 6, 7)
$V_{OLV}$	Quiet Output Minimum Dynamic $V_{OL}$	3.3	-0.5	-0.8		V	(Notes 6, 7)
$V_{IHD}$	Maximum High Level Dynamic Input Voltage	3.3	1.6	2.0		V	(Notes 6, 8)
$V_{ILD}$	Maximum Low Level Dynamic Input Voltage	3.3	1.7	0.8		V	(Notes 6, 8)

**Note 3:** All outputs loaded; thresholds on input associated with output under test.

**Note 4:** Maximum test duration 2.0 ms, one output loaded at a time.

**Note 5:** Incident wave switching on transmission lines with impedances as low as 75Ω for commercial temperature range is guaranteed for 74LVQ.

**Note 6:** Worst case package.

**Note 7:** Max number of outputs defined as (n). Data inputs are driven 0V to 3.3V; one output at GND.

**Note 8:** Max number of Data Inputs (n) switching. (n - 1) inputs switching 0V to 3.3V. Input-under-test switching: 3.3V to threshold ( $V_{ILD}$ ), 0V to threshold ( $V_{IHD}$ ),  $f = 1 \text{ MHz}$ .

## AC Electrical Characteristics

Symbol	Parameter	V <sub>CC</sub> (V)	T <sub>A</sub> = +25°C C <sub>L</sub> = 50 pF			T <sub>A</sub> = -40°C to +85°C C <sub>L</sub> = 50 pF		Units
			Min	Typ	Max	Min	Max	
t <sub>PHL</sub>	Propagation Delay	2.7	2.0	9.0	14.0	2.0	15.0	ns
t <sub>PLH</sub>		3.3 ±0.3	2.0	7.5	10.0	2.0	10.5	
t <sub>PZL</sub>	Output Enable Time	2.7	3.0	10.2	18.3	3.0	19.0	ns
t <sub>PZH</sub>		3.3 ±0.3	3.0	8.5	13.0	3.0	13.5	
t <sub>PHZ</sub>	Output Disable Time	2.7	1.0	10.2	20.4	1.0	21.0	ns
t <sub>PLZ</sub>		3.3 ±0.3	1.0	8.5	14.5	1.0	15.0	
t <sub>OSHL</sub>	Output to Output	2.7		1.0	1.5		1.5	ns
t <sub>OSLH</sub>	Skew (Note 9)	3.3 ±0.3		1.0	1.5		1.5	

**Note 9:** Skew is defined as the absolute value of the difference between the actual propagation delay for any two separate outputs of the same device. The specification applies to any outputs switching in the same direction, either HIGH to LOW (t<sub>OSHL</sub>) or LOW to HIGH (t<sub>OSLH</sub>). Parameter guaranteed by design.

## Capacitance

Symbol	Parameter	Typ	Units	Conditions
C <sub>IN</sub>	Input Capacitance	4.5	pF	V <sub>CC</sub> = Open
C <sub>I/O</sub>	Input/Output Capacitance	15	pF	V <sub>CC</sub> = 3.3V
C <sub>PD</sub> (Note 10)	Power Dissipation Capacitance	67	pF	V <sub>CC</sub> = 3.3V

**Note 10:** C<sub>PD</sub> is measured at 10 MHz.

**Physical Dimensions** inches (millimeters) unless otherwise noted

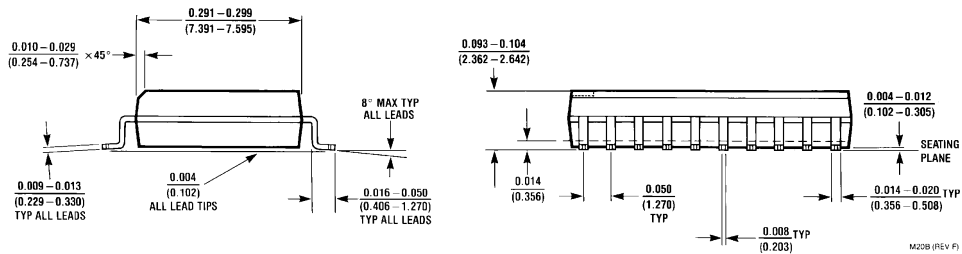
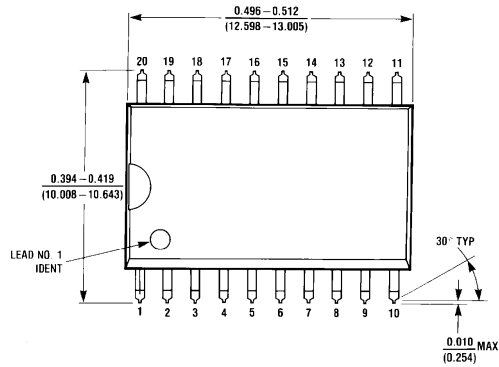

**20-Lead (0.300" Wide) Small Outline Package, SOIC JEDEC  
Package Number M20B**

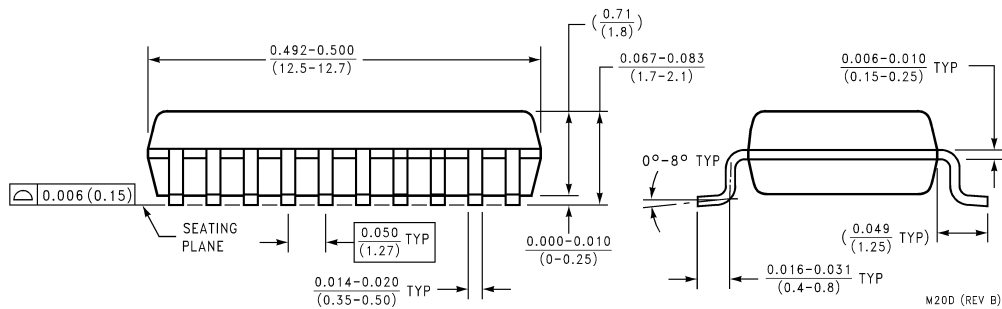
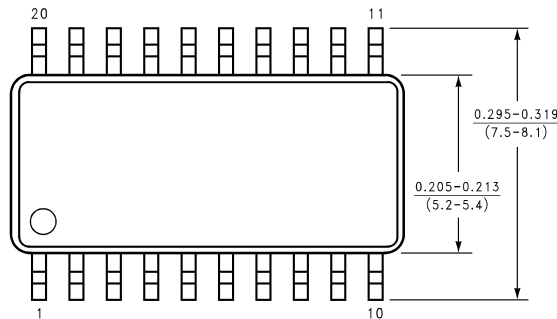

**20-Lead Molded Shrink Small Outline Package, SOIC EIAJ  
Package Number M20D**

