

DM74121 One-Shot with Clear and Complementary Outputs

General Description

The DM74121 is a monostable multivibrator featuring both positive and negative edge triggering with complementary outputs. An internal 2kΩ timing resistor is provided for design convenience minimizing component count and layout problems. This device can be used with a single external capacitor. Inputs (A) are active-LOW trigger transition inputs and input (B) is an active-HIGH transition Schmitt-trigger input that allows jitter-free triggering from inputs with transition rates as slow as 1 volt/second. A high immunity to V_{CC} noise of typically 1.5V is also provided by internal circuitry at the input stage.

To obtain optimum and trouble free operation please read operating rules and one-shot application notes carefully and observe recommendations.

Features

- Triggered from active-HIGH transition or active-LOW transition inputs
- Variable pulse width from 30 ns to 28 seconds
- Jitter free Schmitt-trigger input
- Excellent noise immunity typically 1.2V
- Stable pulse width up to 90% duty cycle
- TTL, DTL compatible
- Compensated for V_{CC} and temperature variations
- Input clamp diodes

Ordering Code:

Order Number	Package Number	Package Description
DM74121N	N14A	14-Lead Plastic Dual-In-Line Package (PDIP), JEDEC MS-001, 0.300 Wide

Connection Diagram

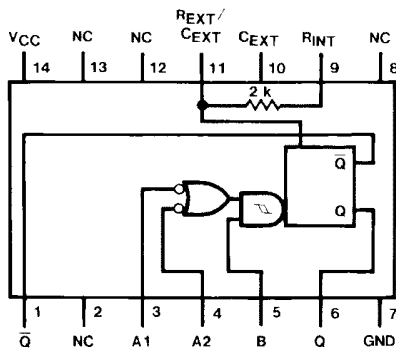

Function Table

Inputs			Outputs	
A1	A2	B	Q	\bar{Q}
L	X	H	L	H
X	L	H	L	H
X	X	L	L	H
H	H	X	L	H
H	↓	H	⌋	⌋
↓	H	H	⌋	⌋
↓	↓	H	⌋	⌋
L	X	↑	⌋	⌋
X	L	↑	⌋	⌋

H = HIGH Logic Level
L = LOW Logic Level
X = Can Be Either LOW or HIGH
⌋ = A Positive Pulse
⌋ = A Negative Pulse
↑ = Positive Going Transition
↓ = Negative Going Transition

Functional Description

The basic output pulse width is determined by selection of an internal resistor R_{INT} or an external resistor (R_X) and capacitor (C_X). Once triggered the output pulse width is independent of further transitions of the inputs and is function of the timing components. Pulse width can vary from a

few nano-seconds to 28 seconds by choosing appropriate R_X and C_X combinations. There are three trigger inputs from the device, two negative edge-triggering (A) inputs, one positive edge Schmitt-triggering (B) input.

Operating Rules

- To use the internal 2 kΩ timing resistor, connect the R_{INT} pin to V_{CC}.
- An external resistor (R_X) or the internal resistor (2 kΩ) and an external capacitor (C_X) are required for proper operation. The value of C_X may vary from 0 to any necessary value. For small time constants use high-quality mica, glass, polypropylene, polycarbonate, or polystyrene capacitors. For large time constants use solid tantalum or special aluminum capacitors. If the timing capacitors have leakages approaching 100 nA or if stray capacitance from either terminal to ground is greater than 50 pF the timing equations may not represent the pulse width the device generates.
- The pulse width is essentially determined by external timing components R_X and C_X. For C_X < 1000 pF see Figure 1 design curves on t_W as function of timing components value. For C_X > 1000 pF the output is defined as:

$$t_W = K R_X C_X$$
 where [R_X is in Kilo-ohm]
 [C_X is in pico Farad]
 [t_W is in nano second]
 [K = 0.7]
- If C_X is an electrolytic capacitor a switching diode is often required for standard TTL one-shots to prevent high inverse leakage current Figure 2.
- Output pulse width versus V_{CC} and operation temperatures: Figure 3 depicts the relationship between pulse width variation versus V_{CC}. Figure 4 depicts pulse width variation versus ambient temperature.
- The "K" coefficient is not a constant, but varies as a function of the timing capacitor C_X. Figure 5 details this characteristic.
- Under any operating condition C_X and R_X must be kept as close to the one-shot device pins as possible to minimize stray capacitance, to reduce noise pick-up, and to reduce I X R and Ldi/dt voltage developed along their connecting paths. If the lead length from C_X to pins (10) and (11) is greater than 3 cm, for example, the output pulse width might be quite different from values predicted from the appropriate equations. A non-inductive and low capacitive path is necessary to ensure complete discharge of C_X in each cycle of its operation so that the output pulse width will be accurate.
- V_{CC} and ground wiring should conform to good high-frequency standards and practices so that switching transients on the V_{CC} and ground return leads do not cause interaction between one-shots. A 0.01 μF to 0.10 μF bypass capacitor (disk ceramic or monolithic type) from V_{CC} to ground is necessary on each device. Furthermore, the bypass capacitor should be located as close to the V_{CC}-pin as space permits.

For further detailed device characteristics and output performance please refer to the one-shot application note, AN-366.

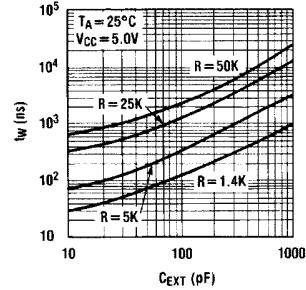

FIGURE 1.

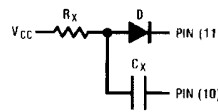

FIGURE 2.

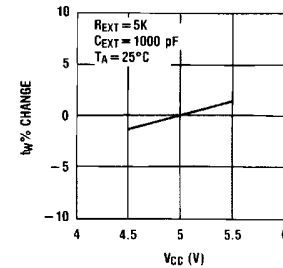

FIGURE 3.

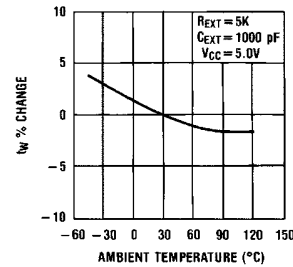

FIGURE 4.

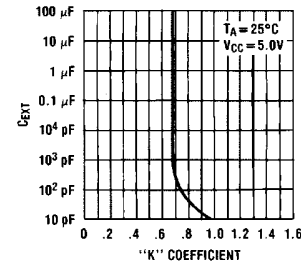

FIGURE 5.

Absolute Maximum Ratings(Note 1)

Supply Voltage	7V
Input Voltage	5.5V
Operating Free Air Temperature Range	0°C to +70°C
Storage Temperature Range	-65°C to +150°C

Note 1: The Absolute Maximum Ratings are those values beyond which the safety of the device cannot be guaranteed. The device should not be operated at these limits. The parametric values defined in the Electrical Characteristics tables are not guaranteed at the absolute maximum ratings. The Recommended Operating Conditions table will define the conditions for actual device operation.

Recommended Operating Conditions

Symbol	Parameter	Min	Nom	Max	Units
V _{CC}	Supply Voltage	4.75	5	5.25	V
V _{T+}	Positive-Going Input Threshold Voltage at the A Input (V _{CC} = Min)		1.4	2	V
V _{T-}	Negative-Going Input Threshold Voltage at the A Input (V _{CC} = Min)	0.8	1.4		V
V _{T+}	Positive-Going Input Threshold Voltage at the B Input (V _{CC} = Min)		1.5	2	V
V _{T-}	Negative-Going Input Threshold Voltage at the B Input (V _{CC} = Min)	0.8	1.3		V
I _{OH}	HIGH Level Output Current			-0.4	mA
I _{OL}	LOW Level Output Current			16	mA
t _W	Input Pulse Width (Note 2)	40			ns
dV/dt	Rate of Rise or Fall of Schmidt Input (B) (Note 2)			1	V/s
dV/dt	Rate of Rise or Fall of Schmidt Input (A) (Note 2)			1	V/μs
R _{EXT}	External Timing Resistor (Note 2)	1.4		40	kΩ
C _{EXT}	External Timing Capacitance (Note 2)	0		1000	μF
DC	Duty Cycle (Note 2)	R _T = 2 kΩ		67	%
		R _T = R _{EXT} (Max)		90	
T _A	Free Air Operating Temperature	0		70	°C

Note 2: T_A = 25°C and V_{CC} = 5V

Electrical Characteristics

over recommended operating free air temperature range (unless otherwise noted)

Symbol	Parameter	Conditions	Min	Typ (Note 3)	Max	Units
V _I	Input Clamp Voltage	V _{CC} = Min, I _I = -12 mA			-1.5	V
V _{OH}	HIGH Level Output Voltage	V _{CC} = Min, I _{OH} = Max, V _{IL} = Max, V _{IH} = Min	2.4	3.4		V
V _{OL}	LOW Level Output Voltage	V _{CC} = Min, I _{OL} = Max, V _{IH} = Max, V _{IL} = Min		0.2	0.4	V
I _I	Input Current @ Max Input Voltage	V _{CC} = Max, V _I = 5.5V			1	mA
I _{IH}	HIGH Level Input Current	V _{CC} = Max, V _I = 2.4V			40	μA
		A1, A2			80	
I _{IL}	LOW Level Input Current	V _{CC} = Max, V _I = 0.4V			-1.6	mA
		A1, A2			-3.2	
I _{OS}	Short Circuit Output Current	V _{CC} = Max (Note 4)	-18		-55	mA
I _{CC}	Supply Current	V _{CC} = Max			25	mA
		Quiescent		13		
		Triggered		23	40	

Note 3: All typicals are at V_{CC} = 5V, T_A = 25°C.

Note 4: Not more than one output should be shorted at a time.

Switching Characteristics

At $V_{CC} = 5V$ and $T_A = 25^\circ C$ (See Test Waveforms and Output Load Section)

Symbol	Parameter	From (Input)	Conditions	Min	Max	Units
		To (Output)				
t_{PLH}	Propagation Delay Time LOW-to-HIGH Level Output	A1, A2 to Q	$C_{EXT} = 80\text{ pF}$ R_{INT} to V_{CC} $C_L = 15\text{ pF}$ $R_L = 400\Omega$		70	ns
t_{PLH}	Propagation Delay Time LOW-to-HIGH Level Output	B to Q			55	ns
t_{PHL}	Propagation Delay Time HIGH-to-LOW Level Output	A1, A2 to \overline{Q}			80	ns
t_{PHL}	Propagation Delay Time HIGH-to-LOW Level Output	B to \overline{Q}			65	ns
$t_{W(OUT)}$	Output Pulse Width Using the Internal Timing Resistor	A1, A2 or B to Q, \overline{Q}	$C_{EXT} = 80\text{ pF}$ R_{INT} to V_{CC} $R_L = 400\Omega$ $C_L = 15\text{ pF}$	70	150	ns
$t_{W(OUT)}$	Output Pulse Width Using Zero Timing Capacitance	A1, A2 to Q, \overline{Q}	$C_{EXT} = 0\text{ pF}$ R_{INT} to V_{CC} $R_L = 400\Omega$ $C_L = 15\text{ pF}$		50	ns
$t_{W(OUT)}$	Output Pulse Width Using External Timing Resistor	A1, A2 to Q, \overline{Q}	$C_{EXT} = 100\text{ pF}$ $R_{INT} = 10\text{ k}\Omega$ $R_L = 400\Omega$ $C_L = 15\text{ pF}$	600	800	ns
		A1, A2 to Q, \overline{Q}	$C_{EXT} = 1\text{ }\mu\text{F}$ $R_{INT} = 10\text{ k}\Omega$ $R_L = 400\Omega$ $C_L = 15\text{ pF}$	6	8	ms

Physical Dimensions inches (millimeters) unless otherwise noted

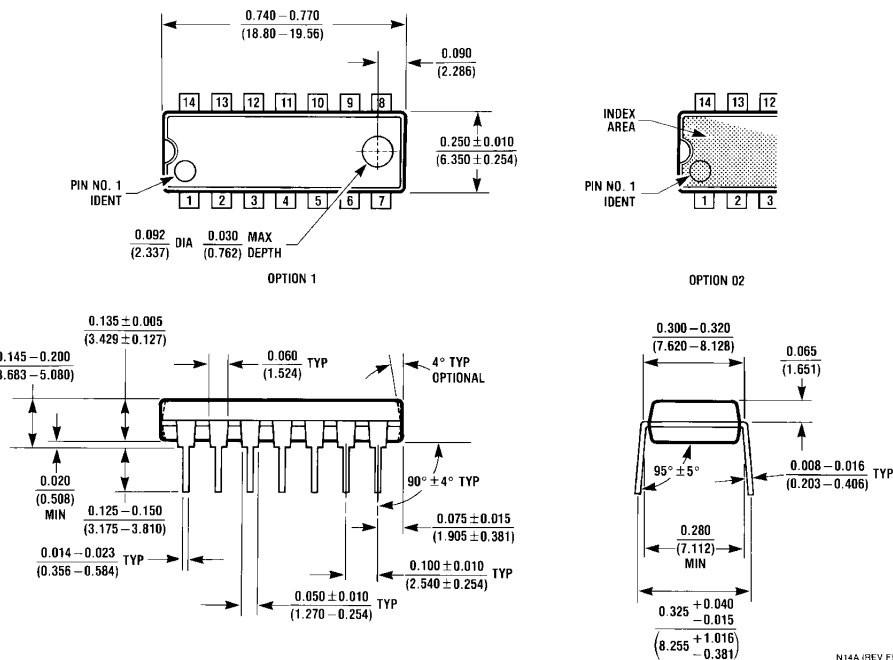

N14A (REV F)

Fairchild does not assume any responsibility for use of any circuitry described, no circuit patent licenses are implied and Fairchild reserves the right at any time without notice to change said circuitry and specifications.

LIFE SUPPORT POLICY

FAIRCHILD'S PRODUCTS ARE NOT AUTHORIZED FOR USE AS CRITICAL COMPONENTS IN LIFE SUPPORT DEVICES OR SYSTEMS WITHOUT THE EXPRESS WRITTEN APPROVAL OF THE PRESIDENT OF FAIRCHILD SEMICONDUCTOR CORPORATION. As used herein:

1. Life support devices or systems are devices or systems which, (a) are intended for surgical implant into the body, or (b) support or sustain life, and (c) whose failure to perform when properly used in accordance with instructions for use provided in the labeling, can be reasonably expected to result in a significant injury to the user.
2. A critical component in any component of a life support device or system whose failure to perform can be reasonably expected to cause the failure of the life support device or system, or to affect its safety or effectiveness.

www.fairchildsemi.com