

MM74HCT138 3-to-8 Line Decoder

General Description

The MM74HCT138 decoder utilizes advanced silicon-gate CMOS technology, and are well suited to memory address decoding or data routing applications. Both circuits feature high noise immunity and low power consumption usually associated with CMOS circuitry, yet have speeds comparable to low power Schottky TTL logic.

The MM74HCT138 have 3 binary select inputs (A, B, and C). If the device is enabled these inputs determine which one of the eight normally HIGH outputs will go LOW. Two active LOW and one active HIGH enables (G1, G2A and G2B) are provided to ease the cascading decoders.

The decoders' output can drive 10 low power Schottky TTL equivalent loads and are functionally and pin equivalent to

the 74LS138. All inputs are protected from damage due to static discharge by diodes to V_{CC} and ground.

MM74HCT devices are intended to interface between TTL and NMOS components and standard CMOS devices. These parts are also plug-in replacements for LS-TTL devices and can be used to reduce power consumption in existing designs.

Features

- TTL input compatible
- Typical propagation delay: 20 ns
- Low quiescent current: 80 μ A maximum (74HCT Series)
- Low input current: 1 μ A maximum
- Fanout of 10 LS-TTL loads

Ordering Code:

Order Number	Package Number	Package Description
MM74HCT138M	M16A	16-Lead Small Outline Integrated Circuit (SOIC), JEDEC MS-012, 0.150" Narrow
MM74HCT138SJ	M16D	16-Lead Small Outline Package (SOP), EIAJ TYPE II, 5.3mm Wide
MM74HCT138MTC	MTC16	16-Lead Thin Shrink Small Outline Package (TSSOP), JEDEC MO-153, 4.4mm Wide
MM74HCT138N	N16E	16-Lead Plastic Dual-In-Line Package (PDIP), JEDEC MS-001, 0.300" Wide

Devices also available in Tape and Reel. Specify by appending the suffix letter "X" to the ordering code.

Connection Diagram

Pin Assignments for DIP, SOIC, SOP and TSSOP

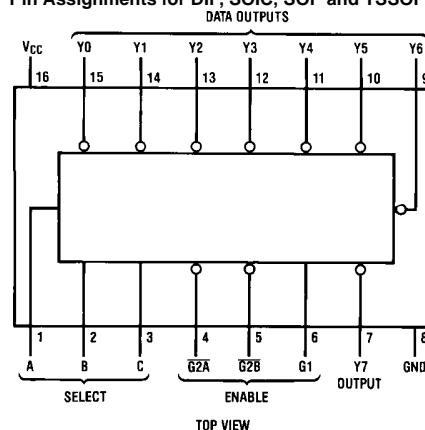

Truth Table

Inputs					Outputs							
Enable		Select			Y0	Y1	Y2	Y3	Y4	Y5	Y6	Y7
G1	$\overline{G2}$ (Note 1)	C	B	A								
X	H	X	X	X	H	H	H	H	H	H	H	H
L	X	X	X	X	H	H	H	H	H	H	H	H
H	L	L	L	L	L	H	H	H	H	H	H	H
H	L	L	L	H	H	L	H	H	H	H	H	H
H	L	L	H	L	H	H	L	H	H	H	H	H
H	L	L	H	H	H	H	L	H	H	H	H	H
H	L	H	L	L	H	H	H	H	L	H	H	H
H	L	H	L	H	H	H	H	H	H	L	H	H
H	L	H	H	L	H	H	H	H	H	H	L	H
H	L	H	H	H	H	H	H	H	H	H	H	L

H = HIGH Level
L = LOW Level
X = Don't Care

Note 1: $\overline{G2} = \overline{G2A} + \overline{G2B}$

Logic Diagram

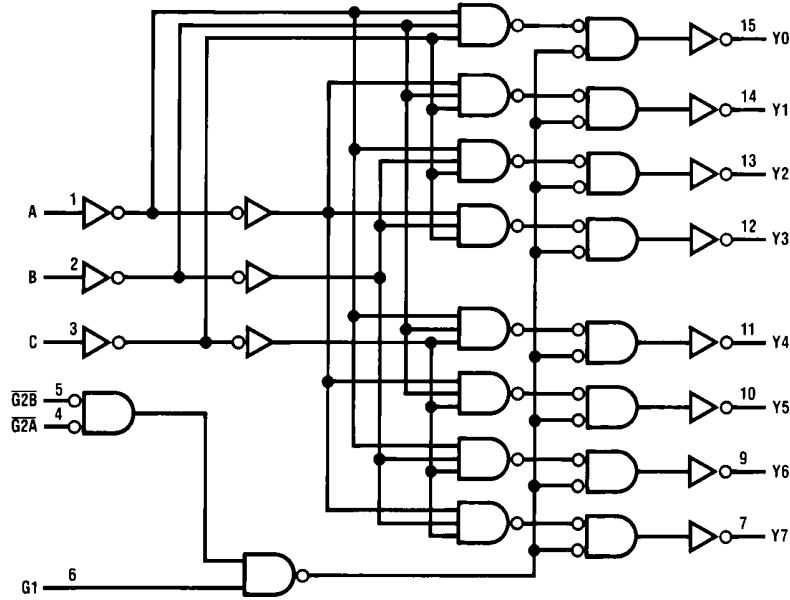

Absolute Maximum Ratings (Note 2)		Recommended Operating Conditions		
Supply Voltage (V_{CC})	-0.5 to +7.0V	Min	Max	Units
DC Input Voltage (V_{IN})	-1.5 to V_{CC} +1.5V	4.5	5.5	V
DC Output Voltage (V_{OUT})	-0.5 to V_{CC} +0.5V			
Clamp Diode Current (I_{IK}, I_{OK})	±20 mA	0	V_{CC}	V
DC Output Current, per pin (I_{OUT})	±25 mA	Operating Temperature Range (T_A)		
DC V_{CC} or GND Current, per pin (I_{CC})	±50 mA	-40	+85	°C
Storage Temperature Range (T_{STG})	-65°C to +150°C	Input Rise or Fall Times		
Power Dissipation (P_D)				(t_r, t_f)
(Note 4)	600 mW			500 ns
S.O. Package only	500 mW	Note 2: Absolute Maximum Ratings are those values beyond which damage to the device may occur.		
Lead Temperature (T_L)		Note 3: Unless otherwise specified all voltages are referenced to ground.		
(Soldering 10 seconds)	260°C	Note 4: Power Dissipation temperature derating — plastic "N" package: -12 mW/°C from 65°C to 85°C.		

DC Electrical Characteristics

$V_{CC} = 5V \pm 10\%$ (unless otherwise specified)

Symbol	Parameter	Conditions	$T_A = 25^\circ C$		$T_A = -40$ to $85^\circ C$	$T_A = -55$ to $125^\circ C$	Units
			Typ	Guaranteed Limits			
V_{IH}	Minimum HIGH Level Input Voltage			2.0	2.0	2.0	V
V_{IL}	Maximum LOW Level Input Voltage			0.8	0.8	0.8	V
V_{OH}	Minimum HIGH Level Output Voltage	$V_{IN} = V_{IH}$ or V_{IL}	V_{CC}	$V_{CC} - 0.1$	$V_{CC} - 0.1$	$V_{CC} - 0.1$	V
		$ I_{OUT} = 20 \mu A$	4.2	3.98	3.84	3.7	V
		$ I_{OUT} = 4.0 \text{ mA}, V_{CC} = 4.5V$ $ I_{OUT} = 4.8 \text{ mA}, V_{CC} = 5.5V$	5.2	4.98	4.84	4.7	V
V_{OL}	Maximum LOW Level Voltage	$V_{IN} = V_{IH}$ or V_{IL}	0	0.1	0.1	0.1	V
		$ I_{OUT} = 20 \mu A$	0.2	0.26	0.33	0.4	V
		$ I_{OUT} = 4.0 \text{ mA}, V_{CC} = 4.5V$ $ I_{OUT} = 4.8 \text{ mA}, V_{CC} = 5.5V$	0.2	0.26	0.33	0.4	V
I_{IN}	Maximum Input Current	$V_{IN} = V_{CC}$ or GND, V_{IH} or V_{IL}		±0.1	±1.0	±1.0	μA
I_{CC}	Maximum Quiescent Supply Current	$V_{IN} = V_{CC}$ or GND $I_{OUT} = 0 \mu A$		8.0	80	160	μA
		$V_{IN} = 2.4V$ or $0.5V$ (Note 5)		0.3	0.4	0.5	mA

Note 5: This is measured per input pin. All other inputs are held at V_{CC} or ground.

AC Electrical Characteristics $T_A = 25^\circ\text{C}$, $V_{CC} = 5.0\text{V}$, $t_r = t_f = 6\text{ ns}$, $C_L = 15\text{ pF}$ (unless otherwise specified)

Symbol	Parameter	Conditions	Typ	Guaranteed Limit	Units
t_{PHL}	Maximum Propagation Delay, A, B, or C to Output		20	35	ns
t_{PLH}	Maximum Propagation Delay, A, B, or C to Output		13	25	ns
t_{PHL}	Maximum Propagation Delay, G1 to Y Output		14	25	ns
t_{PLH}	Maximum Propagation Delay, G1 to Y Output		13	25	ns
t_{PHL}	Maximum Propagation Delay, $\overline{G2A}$ or $\overline{G2B}$ to Y Output		17	30	ns
t_{PLH}	Maximum Propagation Delay, $\overline{G2A}$ or $\overline{G2B}$ to Y Output		13	25	ns

AC Electrical Characteristics $V_{CC} = 5\text{V} \pm 10\%$, $C_L = 50\text{ pF}$, $t_r = t_f = 6\text{ ns}$ (unless otherwise specified)

Symbol	Parameter	Conditions	$T_A = 25^\circ\text{C}$		$T_A = -40\text{ to }85^\circ\text{C}$	$T_A = -55\text{ to }125^\circ\text{C}$	Units
			Typ	Guaranteed Limits			
t_{PHL}	Maximum Propagation Delay A, B, or C to Output		24	40	50	60	ns
t_{PLH}	Maximum Propagation Delay A, B, or C to Output		18	30	38	45	ns
t_{PHL}	Maximum Propagation Delay G1 to Y Output		17	30	38	45	ns
t_{PLH}	Maximum Propagation Delay G1 to Y Output		20	30	38	45	ns
t_{PHL}	Maximum Propagation Delay $\overline{G2A}$ or $\overline{G2B}$ to Y Output		23	35	43	52	ns
t_{PLH}	Maximum Propagation Delay $\overline{G2A}$ or $\overline{G2B}$ to Y Output		18	30	38	45	ns
t_{THL} , t_{TLH}	Maximum Output Rise and Fall Time			15	19	22	ns
C_{IN}	Input Capacitance			5	10	10	pF
C_{PD}	Power Dissipation Capacitance	(Note 6)	55				pF

Note 6: C_{PD} determines the no load dynamic power consumption, $P_D = C_{PD} V_{CC}^2 f + I_{CC} V_{CC}$, and the no load dynamic current consumption, $I_S = C_{PD} V_{CC} f + I_{CC}$.

Physical Dimensions inches (millimeters) unless otherwise noted

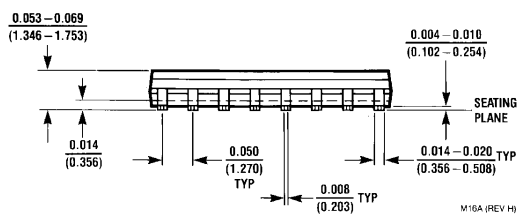
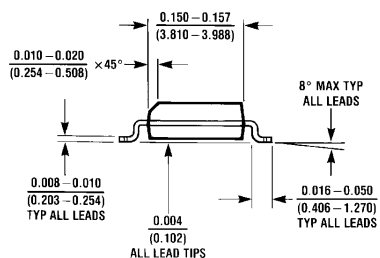
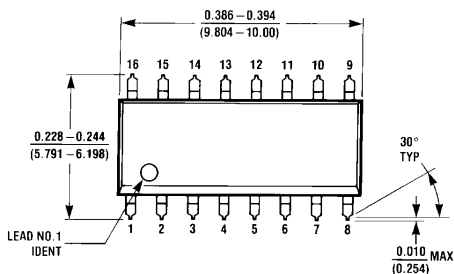

**16-Lead Small Outline Integrated Circuit (SOIC), JEDEC MS-012, 0.150" Narrow
Package Number M16A**

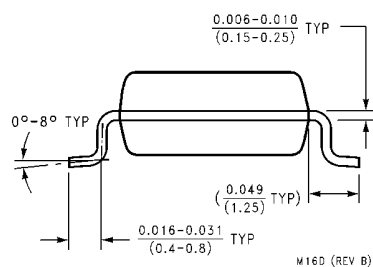
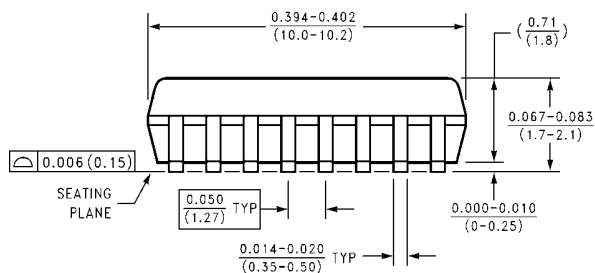
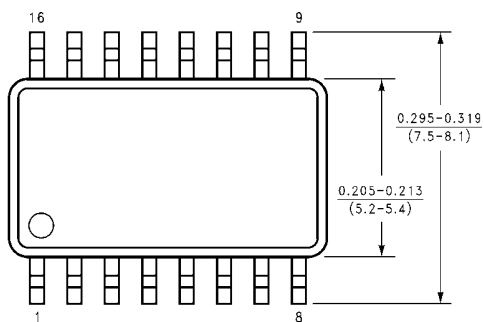

**16-Lead Small Outline Package (SOP), EIAJ TYPE II, 5.3mm Wide
Package Number M16D**

Physical Dimensions inches (millimeters) unless otherwise noted (Continued)

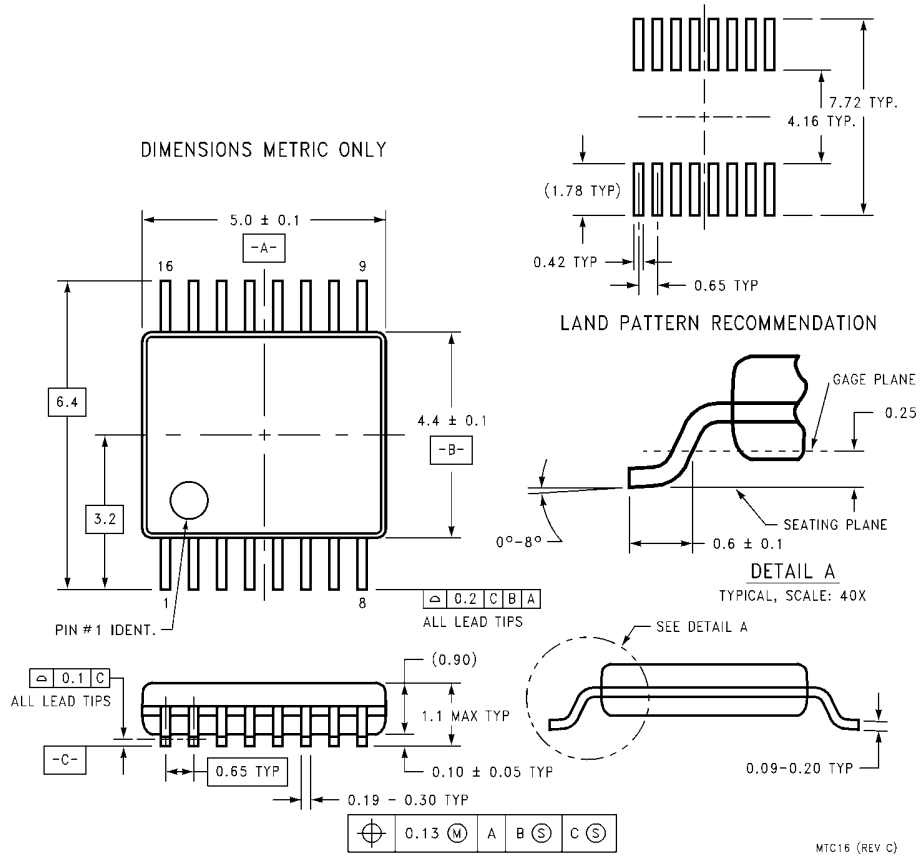

**16-Lead Thin Shrink Small Outline Package (TSSOP), JEDEC MO-153, 4.4mm Wide
Package Number MTC16**

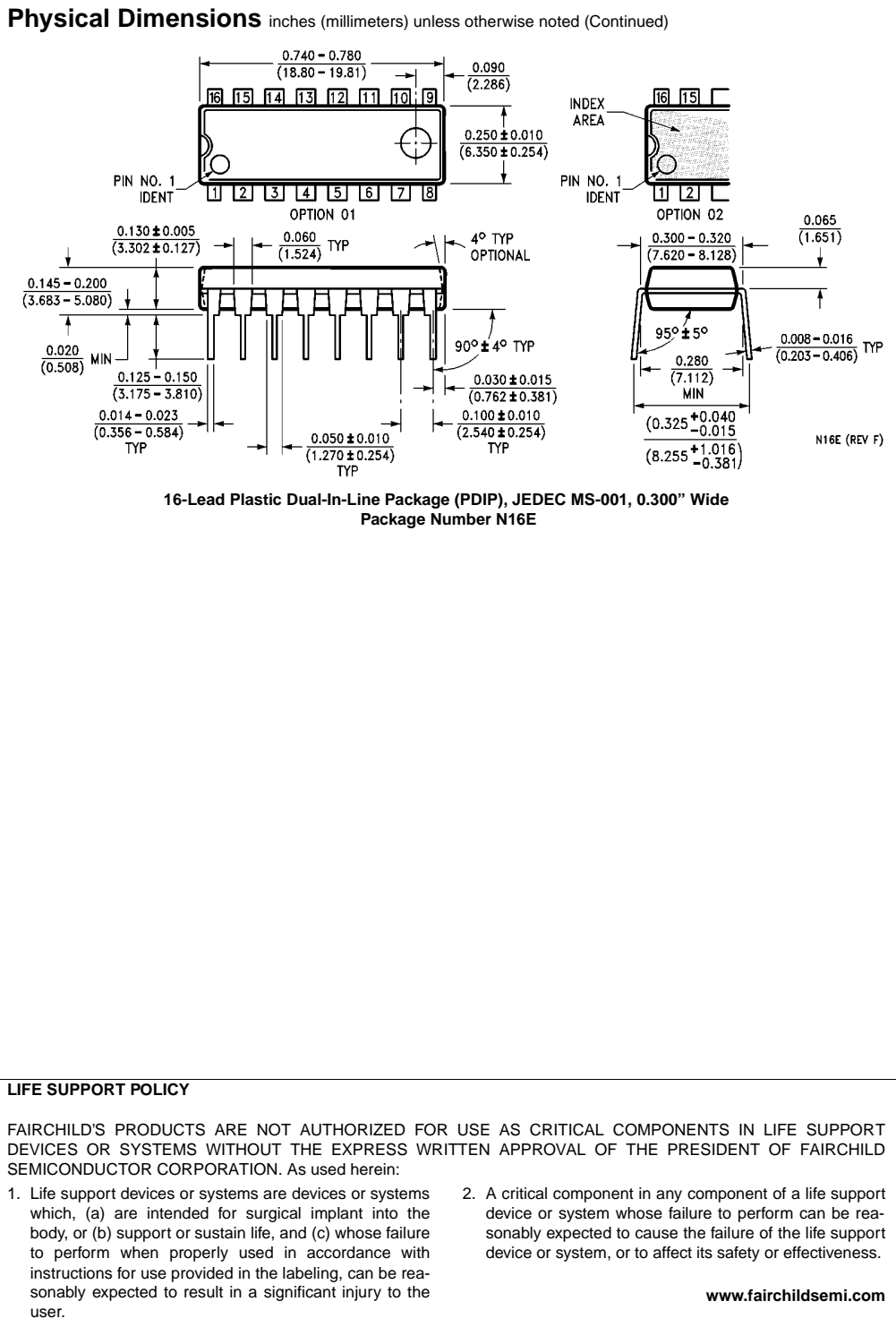

LIFE SUPPORT POLICY

FAIRCHILD'S PRODUCTS ARE NOT AUTHORIZED FOR USE AS CRITICAL COMPONENTS IN LIFE SUPPORT DEVICES OR SYSTEMS WITHOUT THE EXPRESS WRITTEN APPROVAL OF THE PRESIDENT OF FAIRCHILD SEMICONDUCTOR CORPORATION. As used herein:

1. Life support devices or systems are devices or systems which, (a) are intended for surgical implant into the body, or (b) support or sustain life, and (c) whose failure to perform when properly used in accordance with instructions for use provided in the labeling, can be reasonably expected to result in a significant injury to the user.
2. A critical component in any component of a life support device or system whose failure to perform can be reasonably expected to cause the failure of the life support device or system, or to affect its safety or effectiveness.

www.fairchildsemi.com

Fairchild does not assume any responsibility for use of any circuitry described, no circuit patent licenses are implied and Fairchild reserves the right at any time without notice to change said circuitry and specifications.