

General Description:

Half watt, General purpose, Medium Current Surface Mount Zener in the SOD-123 package. The SOD-123 package has the same footprint as the glass mini-melf (LL-34) package & provides a convenient alternative to the Leadless package.

Features:

- Compact surface mount with same footprint as mini-melf
- 500 mW rating on FR-4 or FR-5 board.
- Class 3 ESD rating (>16 kV) per Human Body Model

Ordering:

- 7 inch reel (178 mm); 8 mm Tape; 3,000 units per reel.

Absolute Maximum Ratings (note 1) TA = 25°C unless otherwise noted

Parameter	Value	Units
T _{STG} - Storage Temperature	-55 to +150	°C
T _J - Maximum Junction Temperature	-55 to +150	°C
P _D - Total Power Dissipation at 25°C	500	mW
Derate above 25°C	6.7	mW/°C
R _{θJA} - Thermal Resistance Junction to Ambient	340	°C/W
R _{θJL} - Thermal Resistance Junction to Lead	150	°C/W
ΔV _Z - Maximum Voltage Change (Note 2)	990	mV
Lead Solder Temperature (Max 10 second duration)	260	°C
Nominal Zener Voltage (V _Z) at 50 uA	4.7	V

Note 1: These ratings are limiting values above which the serviceability of any semiconductor device may be impaired

Note 2: Voltage change is equal to the difference between V_Z at 100 uA and V_Z at 10 uA.

Top Mark: CT

1: Cathode

2: Anode

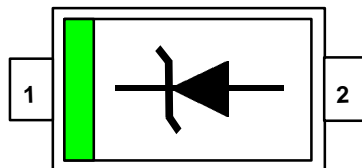

Electrical Characteristics TA = 25°C unless otherwise noted

SYM	CHARACTERISTICS	MIN	MAX	UNITS	TEST CONDITIONS
V _Z	Zener Voltage	4.47	4.94	V	I _{ZT} = 50.0 uA D.C
I _R	Reverse Leakage		10	uA	V _R = 3.0 V
V _F	Forward Voltage		900	mV	I _F = 10 mA
ΔV _Z	Delta Zener Voltage		990	mV	I _F = 100 uA to 10 uA

SOD-123 Tape and Reel Data and Package Dimensions



SOD123 Packaging Configuration: Figure 1.0

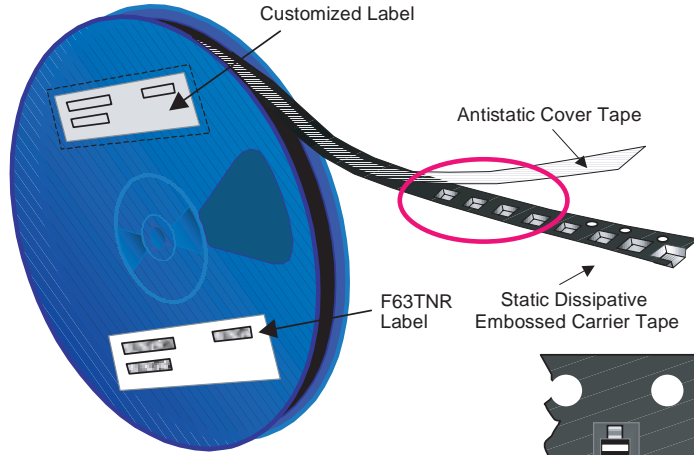

Packaging Description:
 SOD123 parts are shipped in tape. The carrier tape is made from a dissipative (carbon filled) polycarbonate resin. The cover tape is a multilayer film (Heat Activated Adhesive in nature) primarily composed of polyester film, adhesive layer, sealant, and anti-static sprayed agent. These reeled parts in standard option are shipped with 3,000 units per 7" or 177cm diameter reel. The reels are dark blue in color and is made of polystyrene plastic (anti-static coated). Other option comes in 10,000 units per 13" or 330cm diameter reel. This and some other options are described in the Packaging Information table.
 These full reels are individually barcode labeled and placed inside a pizza box (illustrated in figure 1.0) made of recyclable corrugated brown paper with a Fairchild logo printing. One pizza box contains three reels maximum. And these pizza boxes are placed inside a barcode labeled shipping box which comes in different sizes depending on the number of parts shipped.

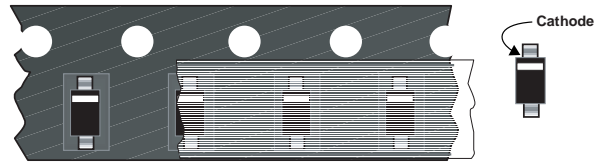

SOD123 Unit Orientation

SOD123 Packaging Information			
Packaging Option	Standard (no flow code)	L99Z	D87Z
Packaging type	TNR	TNR	TNR
Qty per Reel/Tube/Bag	3,000	3,000	10,000
Reel Size	7" Dia	7" Dia	13"
Box Dimension (mm)	184x187x47	184x187x47	343x343x64
Max qty per Box	9,000	9,000	30,000
Weight per unit (gm)	0.01	0.01	0.01
Weight per Reel (kg)	0.123	0.123	0.420
Note/Comments		No marking required	

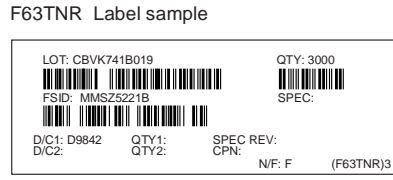
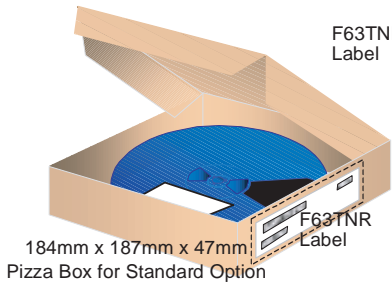
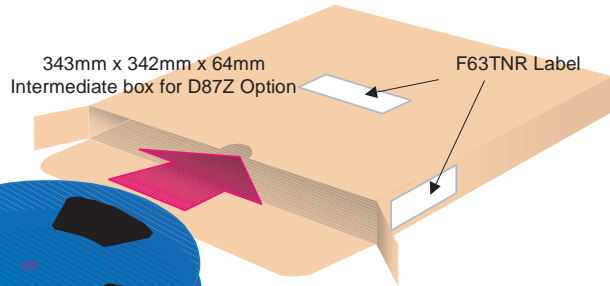

SOD123 Tape Leader and Trailer Configuration: Figure 2.0

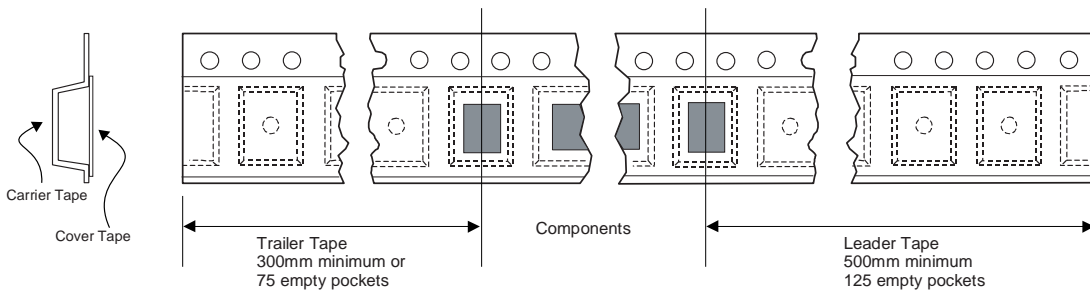

SOD-123 Tape and Reel Data and Package Dimensions, continued

SOD123 Embossed Carrier Tape Configuration: Figure 3.0

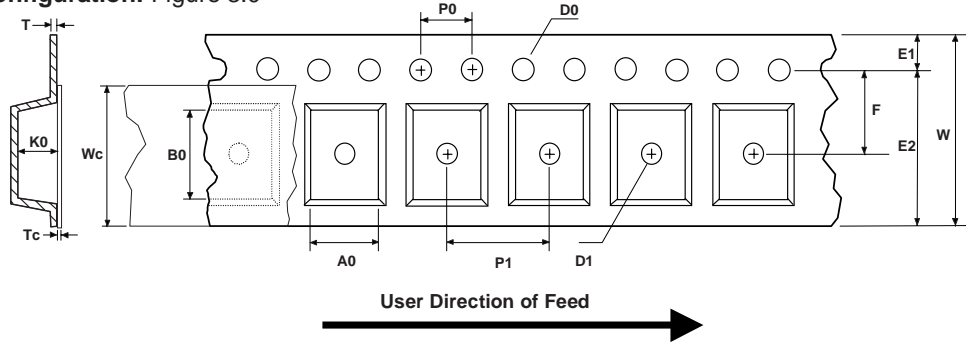

Dimensions are in millimeter

Pkg type	A0	B0	W	D0	D1	E1	E2	F	P1	P0	K0	T	Wc	Tc
SOD123 (8mm)	1.85 +/-0.10	3.94 +/-0.10	8.0 +/-0.3	1.50 +/-0.10	1.125 +/-0.125	1.75 +/-0.10	6.25 min	3.50 +/-0.05	4.0 +/-0.1	4.0 +/-0.1	1.50 +/-0.10	0.200 +/-0.020	5.2 +/-0.2	0.06 +/-0.02

Notes: A0, B0, and K0 dimensions are determined with respect to the EIA/Jedec RS-481 rotational and lateral movement requirements (see sketches A, B, and C).

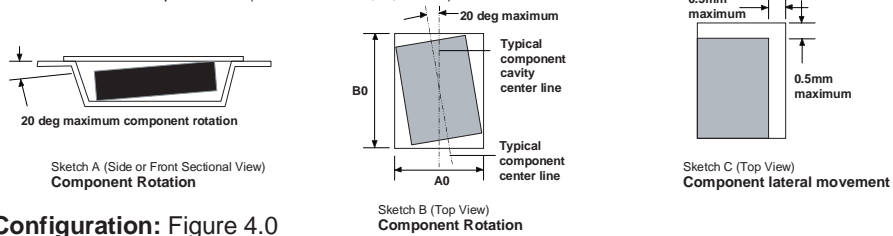

SOD123 Reel Configuration: Figure 4.0

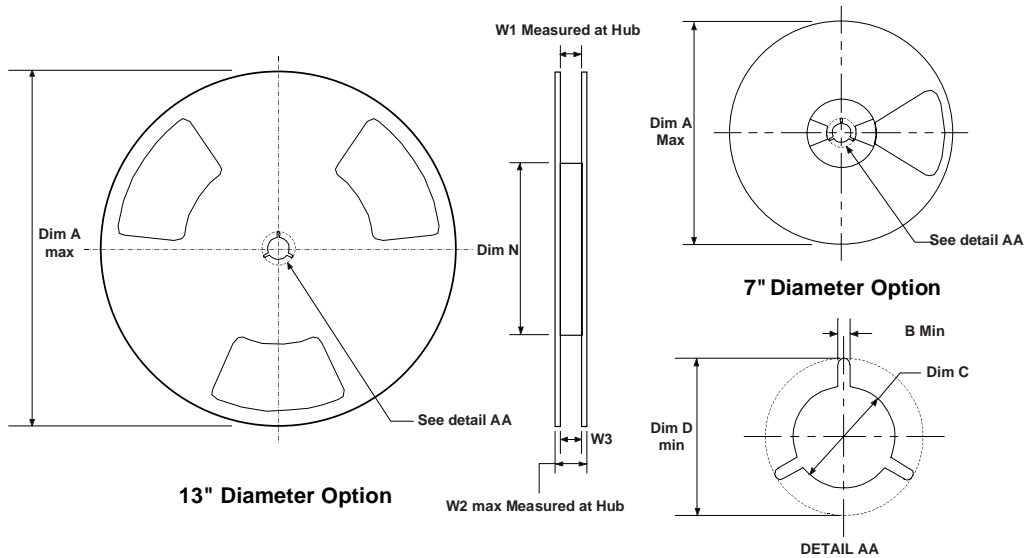

Dimensions are in inches and millimeters

Tape Size	Reel Option	Dim A	Dim B	Dim C	Dim D	Dim N	Dim W1	Dim W2	Dim W3 (LSL-USL)
8mm	7" Dia	7.00 177.8	0.059 1.5	512 +0.020/-0.008 13 +0.5/-0.2	0.795 20.2	2.165 55	0.331 +0.059/-0.000 8.4 +1.5/0	0.567 14.4	0.311 - 0.429 7.9 - 10.9
8mm	13" Dia	13.00 330	0.059 1.5	512 +0.020/-0.008 13 +0.5/-0.2	0.795 20.2	4.00 100	0.331 +0.059/-0.000 8.4 +1.5/0	0.567 14.4	0.311 - 0.429 7.9 - 10.9

SOD-123 Tape and Reel Data and Package Dimensions, continued

SOD-123 (FS PKG Code D6)

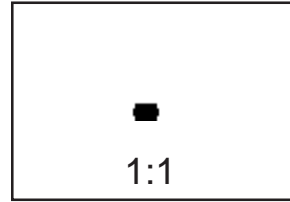

Scale 1:1 on letter size paper

Dimensions shown below are in:
inches [millimeters]

Part Weight per unit (gram): 0.01

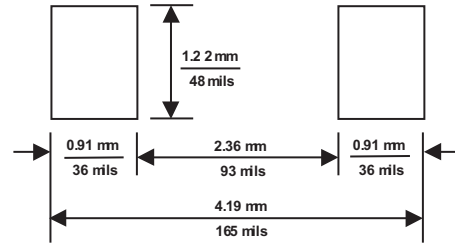
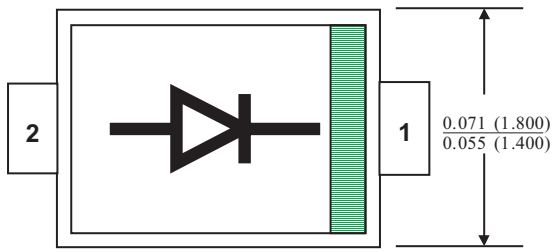

SOD-123 LAND PADS

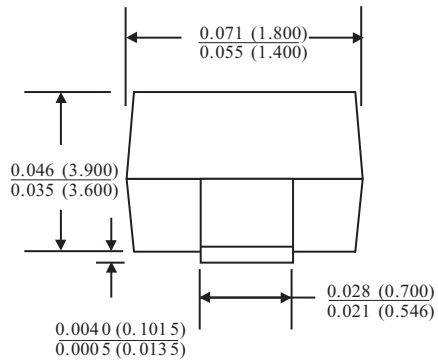
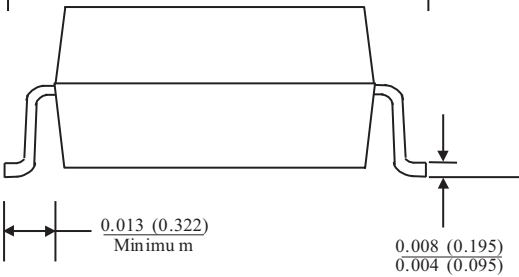
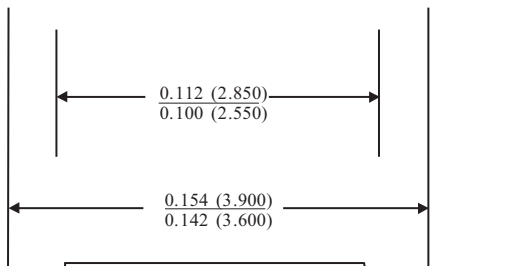

TRADEMARKS

The following are registered and unregistered trademarks Fairchild Semiconductor owns or is authorized to use and is not intended to be an exhaustive list of all such trademarks.

ACEx™	HiSeC™	SuperSOT™-8
Bottomless™	ISOPLANAR™	SyncFET™
CoolFET™	MICROWIRE™	TinyLogic™
CROSSVOLT™	POP™	UHC™
E ² CMOS™	PowerTrench®	VCX™
FACT™	QFET™	
FACT Quiet Series™	QS™	
FAST®	Quiet Series™	
FASTr™	SuperSOT™-3	
GTO™	SuperSOT™-6	

DISCLAIMER

FAIRCHILD SEMICONDUCTOR RESERVES THE RIGHT TO MAKE CHANGES WITHOUT FURTHER NOTICE TO ANY PRODUCTS HEREIN TO IMPROVE RELIABILITY, FUNCTION OR DESIGN. FAIRCHILD DOES NOT ASSUME ANY LIABILITY ARISING OUT OF THE APPLICATION OR USE OF ANY PRODUCT OR CIRCUIT DESCRIBED HEREIN; NEITHER DOES IT CONVEY ANY LICENSE UNDER ITS PATENT RIGHTS, NOR THE RIGHTS OF OTHERS.

LIFE SUPPORT POLICY

FAIRCHILD'S PRODUCTS ARE NOT AUTHORIZED FOR USE AS CRITICAL COMPONENTS IN LIFE SUPPORT DEVICES OR SYSTEMS WITHOUT THE EXPRESS WRITTEN APPROVAL OF FAIRCHILD SEMICONDUCTOR CORPORATION. As used herein:

1. Life support devices or systems are devices or systems which, (a) are intended for surgical implant into the body, or (b) support or sustain life, or (c) whose failure to perform when properly used in accordance with instructions for use provided in the labeling, can be reasonably expected to result in significant injury to the user.
2. A critical component is any component of a life support device or system whose failure to perform can be reasonably expected to cause the failure of the life support device or system, or to affect its safety or effectiveness.

PRODUCT STATUS DEFINITIONS

Definition of Terms

Datasheet Identification	Product Status	Definition
Advance Information	Formative or In Design	This datasheet contains the design specifications for product development. Specifications may change in any manner without notice.
Preliminary	First Production	This datasheet contains preliminary data, and supplementary data will be published at a later date. Fairchild Semiconductor reserves the right to make changes at any time without notice in order to improve design.
No Identification Needed	Full Production	This datasheet contains final specifications. Fairchild Semiconductor reserves the right to make changes at any time without notice in order to improve design.
Obsolete	Not In Production	This datasheet contains specifications on a product that has been discontinued by Fairchild semiconductor. The datasheet is printed for reference information only.