

NM93C56

2048-Bit Serial CMOS EEPROM

(MICROWIRE™ Synchronous Bus)

General Description

NM93C56 is a 2048-bit CMOS non-volatile EEPROM organized as 128 x 16-bit array. This device features MICROWIRE interface which is a 4-wire serial bus with chipselect (CS), clock (SK), data input (DI) and data output (DO) signals. This interface is compatible to many of standard Microcontrollers and Microprocessors. There are 7 instructions implemented on the NM93C56 for various Read, Write, Erase, and Write Enable/Disable operations. This device is fabricated using Fairchild Semiconductor floating-gate CMOS process for high reliability, high endurance and low power consumption.

"LZ" and "L" versions of NM93C56 offer very low standby current making them suitable for low power applications. This device is offered in both SO and TSSOP packages for small space considerations.

Features

- Wide V_{CC} 2.7V - 5.5V
- Typical active current of 200 μ A
- 10 μ A standby current typical
- 1 μ A standby current typical (L)
- 0.1 μ A standby current typical (LZ)
- No Erase instruction required before Write instruction
- Self timed write cycle
- Device status during programming cycles
- 40 year data retention
- Endurance: 1,000,000 data changes
- Packages available: 8-pin SO, 8-pin DIP, 8-pin TSSOP

Functional Diagram

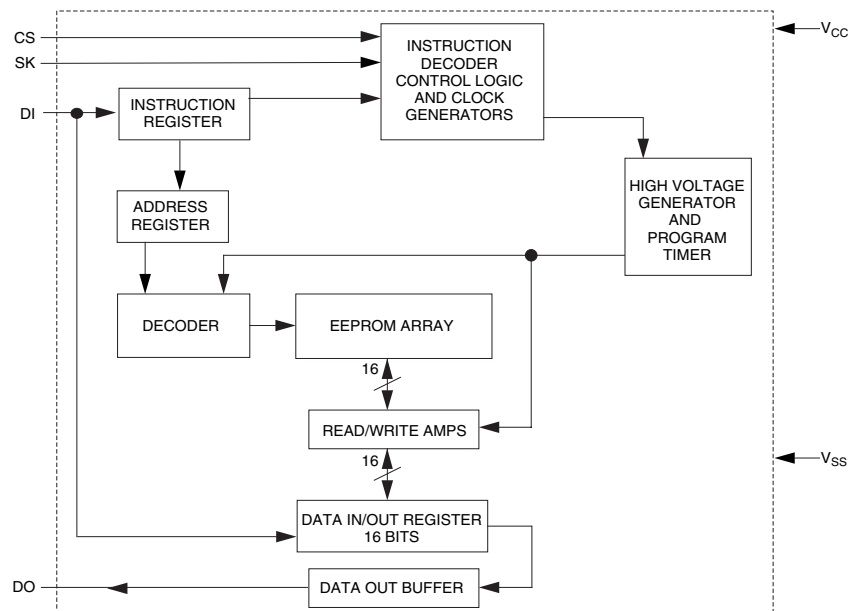

Connection Diagram

**Dual-In-Line Package (N)
 8-Pin SO (M8) and 8-Pin TSSOP (MT8)**

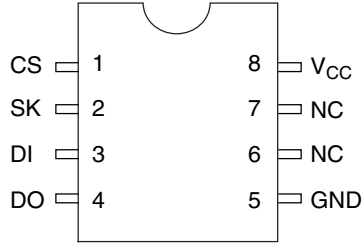

**Top View
 Package Number
 N08E, M08A and MTC08**

Pin Names

CS	Chip Select
SK	Serial Data Clock
DI	Serial Data Input
DO	Serial Data Output
GND	Ground
NC	No Connect
V _{CC}	Power Supply

NOTE: Pins designated as "NC" are typically unbonded pins. However some of them are bonded for special testing purposes. Hence if a signal is applied to these pins, care should be taken that the voltage applied on these pins does not exceed the V_{CC} applied to the device. This will ensure proper operation.

Ordering Information

NM	93	C	XX	LZ	E	XXX		
							Package	N M8 MT8
							Temp. Range	None V E
							Voltage Operating Range	Blank L LZ
							Density	56 C CS
							Interface	93
								Fairchild Memory Prefix
								Letter Description
								8-pin DIP
								8-pin SO
								8-pin TSSOP
								0 to 70°C
								-40 to +125°C
								-40 to +85°C
								4.5V to 5.5V
								2.7V to 5.5V
								2.7V to 5.5V and <1μA Standby Current
								2048 bits
								CMOS
								Data protect and sequential read
								MICROWIRE

Absolute Maximum Ratings (Note 1)

Ambient Storage Temperature	-65°C to +150°C
All Input or Output Voltages with Respect to Ground	+6.5V to -0.3V
Lead Temperature (Soldering, 10 sec.)	+300°C
ESD rating	2000V

Operating Conditions

Ambient Operating Temperature	NM93C56	0°C to +70°C
	NM93C56E	-40°C to +85°C
	NM93C56V	-40°C to +125°C
Power Supply (V_{CC})		4.5V to 5.5V

DC and AC Electrical Characteristics $V_{CC} = 4.5V$ to $5.5V$ unless otherwise specified

Symbol	Parameter	Conditions	Min	Max	Units
I_{CCA}	Operating Current	$CS = V_{IH}$, SK=1.0 MHz		1	mA
I_{CCS}	Standby Current	$CS = V_{IL}$		50	μA
I_{IL} I_{OL}	Input Leakage Output Leakage	$V_{IN} = 0V$ to V_{CC} (Note 2)		± 1	μA
V_{IL} V_{IH}	Input Low Voltage Input High Voltage		-0.1 2	0.8 $V_{CC} + 1$	V
V_{OL1} V_{OH1}	Output Low Voltage Output High Voltage	$I_{OL} = 2.1$ mA $I_{OH} = -400$ μA	2.4	0.4	V
V_{OL2} V_{OH2}	Output Low Voltage Output High Voltage	$I_{OL} = 10$ μA $I_{OH} = -10$ μA	$V_{CC} - 0.2$	0.2	V
f_{SK}	SK Clock Frequency	(Note 3)		1	MHz
t_{SKH}	SK High Time	0°C to +70°C -40°C to +125°C	250 300		ns
t_{SKL}	SK Low Time		250		ns
t_{SKS}	SK Setup Time		50		ns
t_{CS}	Minimum CS Low Time	(Note 4)	250		ns
t_{CSS}	CS Setup Time		100		ns
t_{DH}	DO Hold Time		70		ns
t_{DIS}	DI Setup Time		100		ns
t_{CSH}	CS Hold Time		0		ns
t_{DIH}	DI Hold Time		20		ns
t_{PD}	Output Delay			500	ns
t_{SV}	CS to Status Valid			500	ns
t_{DF}	CS to DO in Hi-Z	$CS = V_{IL}$		100	ns
t_{WP}	Write Cycle Time			10	ms

Absolute Maximum Ratings (Note 1)

Ambient Storage Temperature	-65°C to +150°C
All Input or Output Voltages with Respect to Ground	+6.5V to -0.3V
Lead Temperature (Soldering, 10 sec.)	+300°C
ESD rating	2000V

Operating Conditions

Ambient Operating Temperature	0°C to +70°C
NM93C56L/LZ	-40°C to +85°C
NM93C56LE/LZE	-40°C to +125°C
NM93C56LV/LZV	
Power Supply (V _{CC})	2.7V to 5.5V

DC and AC Electrical Characteristics V_{CC} = 2.7V to 5.5V unless otherwise specified

Symbol	Parameter	Conditions	Min	Max	Units
I _{CCA}	Operating Current	CS = V _{IH} , SK=1.0 MHz		1	mA
I _{CCS}	Standby Current L LZ (2.7V to 4.5V)	CS = V _{IL}		10 1	μA μA
I _{IL} I _{OL}	Input Leakage Output Leakage	V _{IN} = 0V to V _{CC} (Note 2)		±1	μA
V _{IL} V _{IH}	Input Low Voltage Input High Voltage		-0.1 0.8V _{CC}	0.15V _{CC} V _{CC} +1	V
V _{OL} V _{OH}	Output Low Voltage Output High Voltage	I _{OL} = 10μA I _{OH} = -10μA	0.9V _{CC}	0.1V _{CC}	V
f _{SK}	SK Clock Frequency	(Note 3)	0	250	KHz
t _{SKH}	SK High Time		1		μs
t _{SKL}	SK Low Time		1		μs
t _{SKS}	SK Setup Time		0.2		μs
t _{CS}	Minimum CS Low Time	(Note 4)	1		μs
t _{CSS}	CS Setup Time		0.2		μs
t _{DH}	DO Hold Time		70		ns
t _{DIS}	DI Setup Time		0.4		μs
t _{CSH}	CS Hold Time		0		ns
t _{DIH}	DI Hold Time		0.4		μs
t _{PD}	Output Delay			2	μs
t _{SV}	CS to Status Valid			1	μs
t _{DF}	CS to DO in Hi-Z	CS = V _{IL}		0.4	μs
t _{WP}	Write Cycle Time			15	ms

Capacitance T_A = 25°C, f = 1 MHz (Note 5)

Symbol	Test	Typ	Max	Units
C _{OUT}	Output Capacitance		5	pF
C _{IN}	Input Capacitance		5	pF

Note 1: Stress above those listed under "Absolute Maximum Ratings" may cause permanent damage to the device. This is a stress rating only and functional operation of the device at these or any other conditions above those indicated in the operational sections of the specification is not implied. Exposure to absolute maximum rating conditions for extended periods may affect device reliability.

Note 2: Typical leakage values are in the 20nA range.

Note 3: The shortest allowable SK clock period = 1/f_{SK} (as shown under the f_{SK} parameter). Maximum SK clock speed (minimum SK period) is determined by the interaction of several AC parameters stated in the datasheet. Within this SK period, both t_{SKH} and t_{SKL} limits must be observed. Therefore, it is not allowable to set 1/f_{SK} = t_{SKHminimum} + t_{SKLminimum} for shorter SK cycle time operation.

Note 4: CS (Chip Select) must be brought low (to V_{IL}) for an interval of t_{CS} in order to reset all internal device registers (device reset) prior to beginning another opcode cycle. (This is shown in the opcode diagram on the following page.)

Note 5: This parameter is periodically sampled and not 100% tested.

AC Test Conditions

V _{CC} Range	V _{IL} /V _{IH} Input Levels	V _{IL} /V _{IH} Timing Level	V _{OL} /V _{OH} Timing Level	I _{OL} /I _{OH}
2.7V ≤ V _{CC} ≤ 5.5V (Extended Voltage Levels)	0.3V/1.8V	1.0V	0.8V/1.5V	±10μA
4.5V ≤ V _{CC} ≤ 5.5V (TTL Levels)	0.4V/2.4V	1.0V/2.0V	0.4V/2.4V	2.1mA/-0.4mA
Output Load: 1 TTL Gate (C _L = 100 pF)				

Pin Description

Chip Select (CS)

This is an active high input pin to NM93C56 EEPROM (the device) and is generated by a master that is controlling the device. A high level on this pin selects the device and a low level deselects the device. All serial communications with the device is enabled only when this pin is held high. However this pin cannot be permanently tied high, as a rising edge on this signal is required to reset the internal state-machine to accept a new cycle and a falling edge to initiate an internal programming after a write cycle. All activity on the SK, DI and DO pins are ignored while CS is held low.

Serial Clock (SK)

This is an input pin to the device and is generated by the master that is controlling the device. This is a clock signal that synchronizes the communication between a master and the device. All input information (DI) to the device is latched on the rising edge of this clock input, while output data (DO) from the device is driven from the rising edge of this clock input. This pin is gated by CS signal.

Serial Input (DI)

This is an input pin to the device and is generated by the master that is controlling the device. The master transfers Input information (Start bit, Opcode bits, Array addresses and Data) serially via this pin into the device. This Input information is latched on the rising edge of the SCK. This pin is gated by CS signal.

Serial Output (DO)

This is an output pin from the device and is used to transfer Output data via this pin to the controlling master. Output data is serially shifted out on this pin from the rising edge of the SCK. This pin is active only when the device is selected.

Microwire Interface

A typical communication on the Microwire bus is made through the CS, SK, DI and DO signals. To facilitate various operations on the Memory array, a set of 7 instructions are implemented on NM93C56. The format of each instruction is listed under Table 1.

Instruction

Each of the 7 instructions is explained under individual instruction descriptions.

Start bit

This is a 1-bit field and is the first bit that is clocked into the device when a Microwire cycle starts. This bit has to be "1" for a valid cycle to begin. Any number of preceding "0" can be clocked into the device before clocking a "1".

Opcode

This is a 2-bit field and should immediately follow the start bit. These two bits (along with 2 MSB of address field) select a particular instruction to be executed.

Address Field

This is an 8-bit field and should immediately follow the Opcode bits. In NM93C56, only the LSB 7 bits are used for address decoding during READ, WRITE and ERASE instructions. During these three instructions (READ, WRITE and ERASE), the MSB is "don't care" (can be 0 or 1). During all other instructions, the MSB 2 bits are used to decode instruction (along with Opcode bits).

Data Field

This is a 16-bit field and should immediately follow the Address bits. Only the WRITE and WRALL instructions require this field. D15 (MSB) is clocked first and D0 (LSB) is clocked last (both during writes as well as reads).

Table 1. Instruction set

Instruction	Start Bit	Opcode Field	Address Field								Data Field
			X	A6	A5	A4	A3	A2	A1	A0	
READ	1	10	X	A6	A5	A4	A3	A2	A1	A0	
WEN	1	00	1	1	X	X	X	X	X	X	
WRITE	1	01	X	A6	A5	A4	A3	A2	A1	A0	D15-D0
WRALL	1	00	0	1	X	X	X	X	X	X	D15-D0
WDS	1	00	0	0	X	X	X	X	X	X	
ERASE	1	11	X	A6	A5	A4	A3	A2	A1	A0	
ERAL	1	00	1	0	X	X	X	X	X	X	

Functional Description

A typical Microwire cycle starts by first selecting the device (bringing the CS signal high). Once the device is selected, a valid Start bit (“1”) should be issued to properly recognize the cycle. Following this, the 2-bit opcode of appropriate instruction should be issued. After the opcode bits, the 8-bit address information should be issued. For certain instructions, some of these 8 bits are don't care values (can be “0” or “1”), but they should still be issued. Following the address information, depending on the instruction (WRITE and WRALL), 16-Bit data is issued. Otherwise, depending on the instruction (READ), the device starts to drive the output data on the DO line. Other instructions perform certain control functions and do not deal with data bits. The Microwire cycle ends when the CS signal is brought low. However during certain instructions, falling edge of the CS signal initiates an internal cycle (Programming), and the device remains busy till the completion of the internal cycle. Each of the 7 instructions is explained in detail in the following sections.

1) Read (READ)

READ instruction allows data to be read from a selected location in the memory array. Input information (Start bit, Opcode and Address) for this instruction should be issued as listed under Table1. Upon receiving a valid input information, decoding of the opcode and the address is made, followed by data transfer from the selected memory location into a 16-bit serial-out shift register. This 16-bit data is then shifted out on the DO pin. D15 bit (MSB) is shifted out first and D0 bit (LSB) is shifted out last. A dummy-bit (logical 0) precedes this 16-bit data output string. Output data changes are initiated on the rising edge of the SK clock. After reading the 16-bit data, the CS signal can be brought low to end the Read cycle. Refer *Read cycle diagram*.

2) Write Enable (WEN)

When V_{CC} is applied to the part, it “powers up” in the Write Disable (WDS) state. Therefore, all programming operations must be preceded by a Write Enable (WEN) instruction. Once a Write Enable instruction is executed, programming remains enabled until a Write Disable (WDS) instruction is executed or V_{CC} is completely removed from the part. Input information (Start bit, Opcode and Address) for this WEN instruction should be issued as listed under Table1. The device becomes write-enabled at the end of this cycle when the CS signal is brought low. Execution of a READ instruction is independent of WEN instruction. Refer *Write Enable cycle diagram*.

3) Write (WRITE)

WRITE instruction allows write operation to a specified location in the memory with a specified data. This instruction is valid only when

- Device is write-enabled (Refer WEN instruction)

Input information (Start bit, Opcode, Address and Data) for this WRITE instruction should be issued as listed under Table1. After inputting the last bit of data (D0 bit), CS signal must be brought low before the next rising edge of the SK clock. This falling edge of the CS initiates the self-timed programming cycle. It takes t_{WP} time (Refer appropriate DC and AC Electrical Characteristics table) for the internal programming cycle to finish. During this time, the device remains busy and is not ready for another instruction.

The status of the internal programming cycle can be polled at any time by bringing the CS signal high again, after t_{CS} interval. When CS signal is high, the DO pin indicates the READY/BUSY status of the chip. DO = logical 0 indicates that the programming is still in progress. DO = logical 1 indicates that the programming is finished and the device is ready for another instruction. It is not required to provide the SK clock during this status polling. While the device is busy, it is recommended that no new instruction be issued. Refer *Write cycle diagram*.

It is also recommended to follow this instruction (after the device becomes READY) with a Write Disable (WDS) instruction to safeguard data against corruption due to spurious noise, inadvertent writes etc.

4) Write All (WRALL)

Write all (WRALL) instruction is similar to the Write instruction except that WRALL instruction will simultaneously program all memory locations with the data pattern specified in the instruction. This instruction is valid only when

- Device is write-enabled (Refer WEN instruction)

Input information (Start bit, Opcode, Address and Data) for this WRALL instruction should be issued as listed under Table1. After inputting the last bit of data (D0 bit), CS signal must be brought low before the next rising edge of the SK clock. This falling edge of the CS initiates the self-timed programming cycle. It takes t_{WP} time (Refer appropriate DC and AC Electrical Characteristics table) for the internal programming cycle to finish. During this time, the device remains busy and is not ready for another instruction. Status of the internal programming can be polled as described under WRITE instruction description. While the device is busy, it is recommended that no new instruction be issued. Refer *Write All cycle diagram*.

5) Write Disable (WDS)

Write Disable (WDS) instruction disables all programming operations and should follow all programming operations. Executing this instruction after a valid write instruction would protect against accidental data disturb due to spurious noise, glitches, inadvertent writes etc. Input information (Start bit, Opcode and Address) for this WDS instruction should be issued as listed under Table1. The device becomes write-disabled at the end of this cycle when the CS signal is brought low. Execution of a READ instruction is independent of WDS instruction. Refer *Write Disable cycle diagram*.

6) Erase (ERASE)

The ERASE instruction will program all bits in the specified location to a logical “1” state. Input information (Start bit, Opcode and Address) for this WDS instruction should be issued as listed under Table1. After inputting the last bit of data (A0 bit), CS signal must be brought low before the next rising edge of the SK clock. This falling edge of the CS initiates the self-timed programming cycle. It takes t_{WP} time (Refer appropriate DC and AC Electrical Characteristics table) for the internal programming cycle to finish. During this time, the device remains busy and is not ready for another instruction. Status of the internal programming can be polled as described under WRITE instruction description. While the device is busy, it is recommended that no new instruction be issued. Refer *Erase cycle diagram*.

7) Erase All (ERAL)

The Erase all instruction will program all locations to a logical "1" state. Input information (Start bit, Opcode and Address) for this WDS instruction should be issued as listed under Table 1. After inputting the last bit of data (A0 bit), CS signal must be brought low before the next rising edge of the SK clock. This falling edge of the CS initiates the self-timed programming cycle. It takes t_{WP} time (Refer appropriate DC and AC Electrical Characteristics table) for the internal programming cycle to finish. During this time, the device remains busy and is not ready for another instruction. Status of the internal programming can be polled as described under WRITE instruction description. While the device is busy, it is recommended that no new instruction be issued. Refer *Erase All cycle diagram*.

Note: The Fairchild CMOS EEPROMs do not require an "ERASE" or "ERASE ALL" instruction prior to the "WRITE" or "WRITE ALL" instruction, respectively. The "ERASE" and "ERASE ALL" instructions are included to maintain compatibility with earlier technology EEPROMs. Clearing of Ready/Busy status

When programming is in progress, the Data-Out pin will display the programming status as either BUSY (low) or READY (high) when CS is brought high (DO output will be tri-stated when CS is low). To restate, during programming, the CS pin may be brought high and low any number of times to view the programming status without affecting the programming operation. Once programming is completed (Output in READY state), the output is 'cleared' (returned to normal tri-state condition) by clocking in a Start Bit. After the Start Bit is clocked in, the output will return to a tri-stated condition. When clocked in, this Start Bit can be the first bit in a command string, or CS can be brought low again to reset all internal circuits. Refer *Clearing Ready Status* diagram.

Related Document

Application Note: AN758 - Using Fairchild's MICROWIRE™ EEPROM.

Timing Diagrams

SYNCHRONOUS DATA TIMING

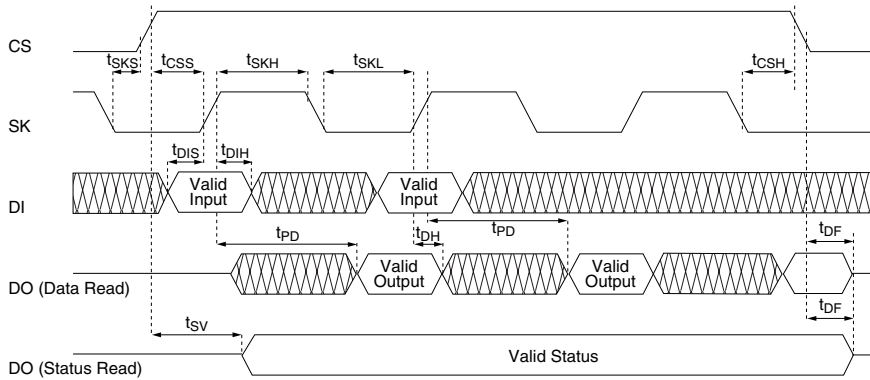

READ CYCLE (READ)

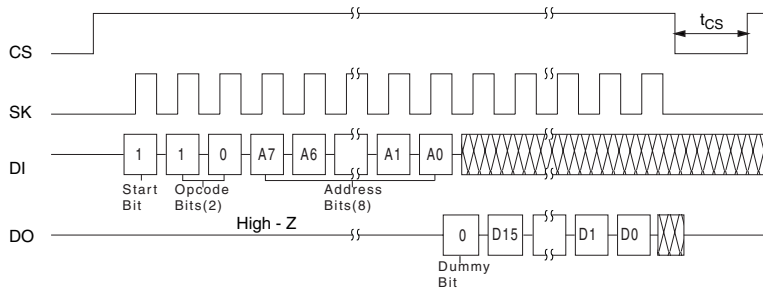

93C56:
 Address bits pattern -> 0-A6-A5-A4-A3-A2-A1-A0; (A6-A0 -> User defined)

WRITE ENABLE CYCLE (WEN)

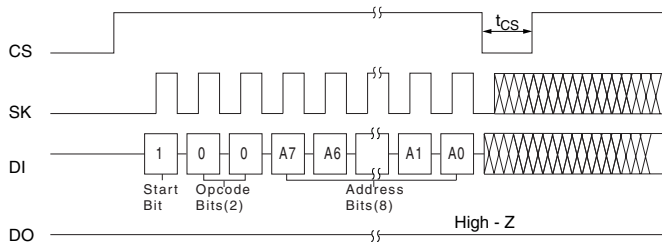

93C56:
 Address bits pattern -> 1-1-x-x-x-x-x-x; (x -> Don't Care, can be 0 or 1)

Timing Diagrams (Continued)

WRITE DISABLE CYCLE (WDS)

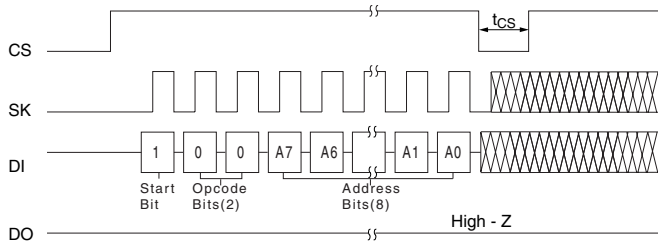

93C56:
 Address bits pattern -> 0-0-x-x-x-x-x-x; (x -> Don't Care, can be 0 or 1)

WRITE CYCLE (WRITE)

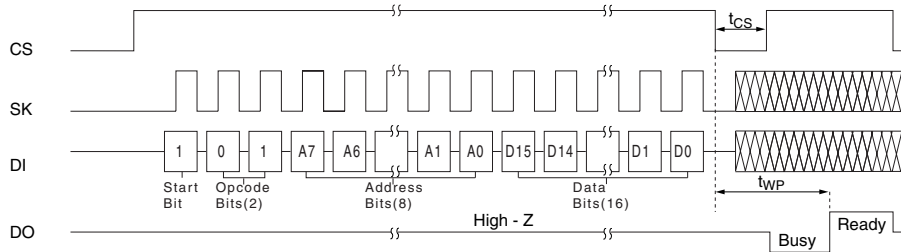

93C56:
 Address bits pattern -> 0-A6-A5-A4-A3-A2-A1-A0; (A6-A0 -> User defined)
 Data bits pattern -> User defined

WRITE ALL CYCLE (WRALL)

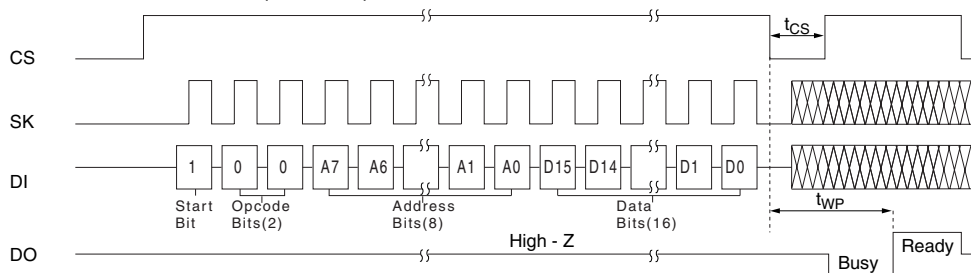

93C56:
 Address bits pattern -> 0-1-x-x-x-x-x-x; (x -> Don't Care, can be 0 or 1)
 Data bits pattern -> User defined

Timing Diagrams (Continued)

ERASE CYCLE (ERASE)

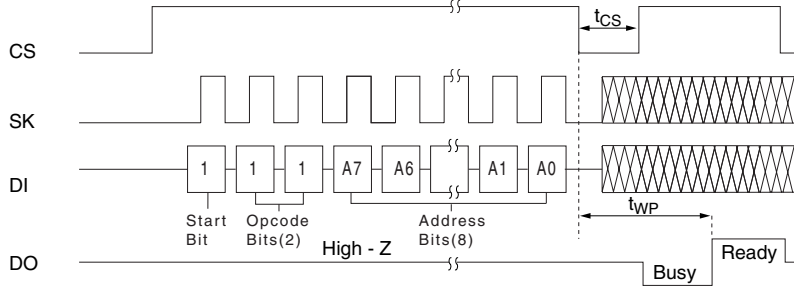

93C56:
 Address bits pattern -> 0-A6-A5-A4-A3-A2-A1-A0; (A6-A0 -> User defined)

ERASE ALL CYCLE (ERAL)

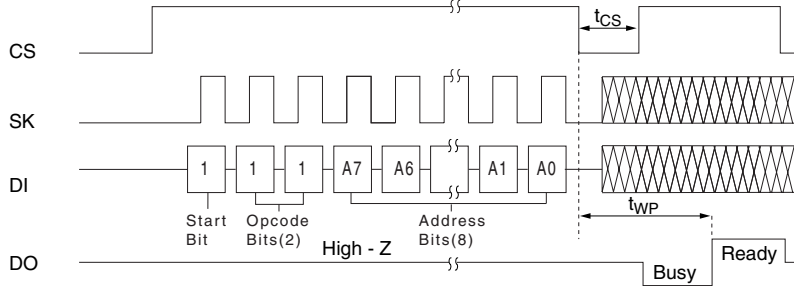

93C56:
 Address bits pattern -> 1-0-x-x-x-x-x-x-x; (x -> Don't Care, can be 0 or 1)

CLEARING READY STATUS

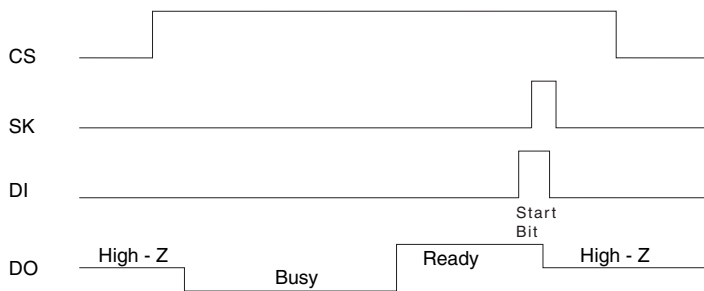

Note: This Start bit can also be part of a next instruction. Hence the cycle can be continued (instead of getting terminated, as shown) as if a new instruction is being issued.

Physical Dimensions inches (millimeters) unless otherwise noted

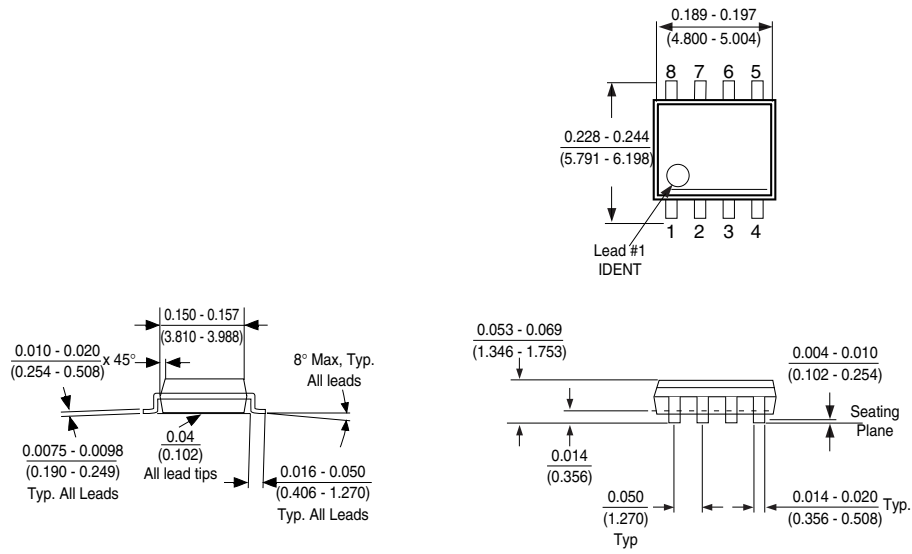

Molded Package, Small Outline, 0.15 Wide, 8-Lead (M8)
Package Number M08A

Physical Dimensions inches (millimeters) unless otherwise noted

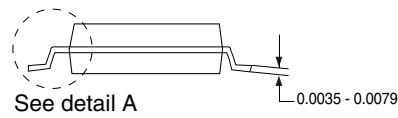
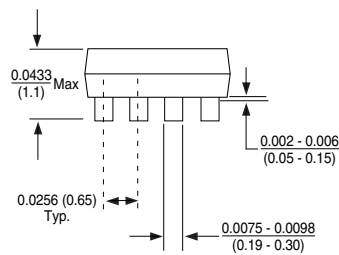
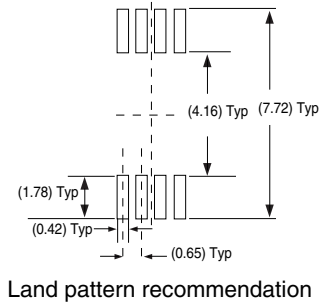
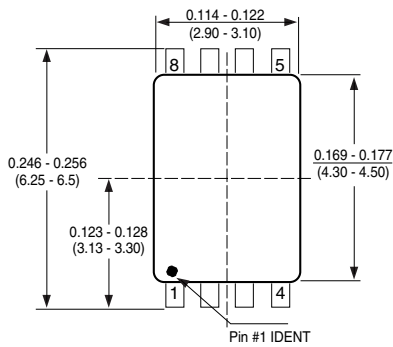

DETAIL A
Typ. Scale: 40X

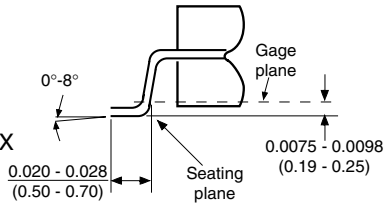

Notes: Unless otherwise specified

1. Reference JEDEC registration MO153. Variation AA. Dated 7/93

8-Pin Molded TSSOP, JEDEC (MT8)
Package Number MTC08

Physical Dimensions inches (millimeters) unless otherwise noted

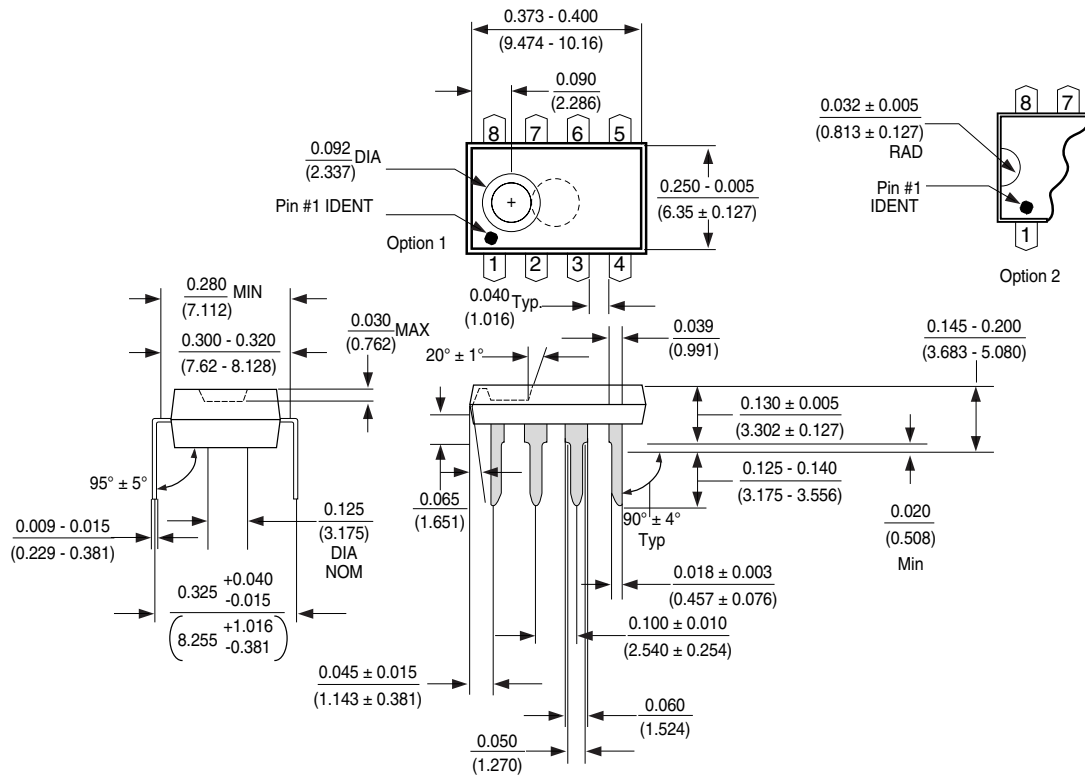

**Molded Dual-In-Line Package (N)
Package Number N08E**

Life Support Policy

Fairchild's products are not authorized for use as critical components in life support devices or systems without the express written approval of the President of Fairchild Semiconductor Corporation. As used herein:

1. Life support devices or systems are devices or systems which, (a) are intended for surgical implant into the body, or (b) support or sustain life, and whose failure to perform, when properly used in accordance with instructions for use provided in the labeling, can be reasonably expected to result in a significant injury to the user.
2. A critical component is any component of a life support device or system whose failure to perform can be reasonably expected to cause the failure of the life support device or system, or to affect its safety or effectiveness.

Fairchild Semiconductor Americas
Customer Response Center
 Tel. 1-888-522-5372

Fairchild Semiconductor Europe
 Fax: +44 (0) 1793-856858
 Deutsch Tel: +49 (0) 8141-6102-0
 English Tel: +44 (0) 1793-856856
 Français Tel: +33 (0) 1-6930-3696
 Italiano Tel: +39 (0) 2-249111-1

Fairchild Semiconductor Hong Kong
 8/F, Room 808, Empire Centre
 68 Mody Road, Tsimshatsui East
 Kowloon, Hong Kong
 Tel: +852-2722-8338
 Fax: +852-2722-8383

Fairchild Semiconductor Japan Ltd.
 4F, Natsume Bldg.
 2-18-6, Yushima, Bunkyo-ku
 Tokyo, 113-0034 Japan
 Tel: 81-3-3818-8840
 Fax: 81-3-3818-8841

Fairchild does not assume any responsibility for use of any circuitry described, no circuit patent licenses are implied and Fairchild reserves the right at any time without notice to change said circuitry and specifications.