

52A, 30V, 0.019 Ohm, N-Channel Logic Level, Power MOSFETs

These are N-Channel enhancement mode silicon gate power field effect transistors. They are advanced power MOSFETs designed, tested, and guaranteed to withstand a specified level of energy in the breakdown avalanche mode of operation. All of these power MOSFETs are designed for applications such as switching regulators, switching converters, motor drivers, relay drivers, and drivers for high power bipolar switching transistors requiring high speed and low gate drive power. These types can be operated directly from integrated circuits.

Ordering Information

PART NUMBER	PACKAGE	BRAND
HPLU3103	TO-251AA	HP3103
HPLR3103	TO-252AA	HP3103

NOTE: When ordering, use the entire part number. Add the suffix T to obtain the TO-252AA variant in tape and reel, e.g., HPLR3103T.

Features

- Logic Level Gate Drive
- 52A†, 30V
- Low On-Resistance, $r_{DS(ON)} = 0.019\Omega$
- UIS Rating Curve
- Related Literature
 - TB334, "Guidelines for Soldering Surface Mount Components to PC Boards"

† Calculated continuous current based on maximum allowable junction temperature. Package limited to 20A continuous, see Figure 9.

Symbol

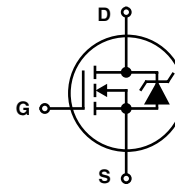

Packaging

JEDEC TO-251AA

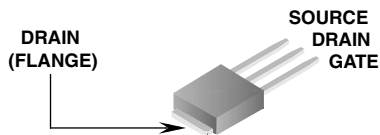

JEDEC TO-252AA

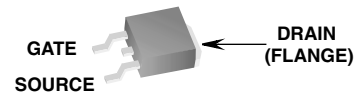

HPLR3103, HPLU3103

Absolute Maximum Ratings $T_C = 25^\circ\text{C}$, Unless Otherwise Specified

	HPLR3103, HPLU3103	UNITS
Drain to Source Voltage (Note 1)	30	V
Drain to Gate Voltage ($R_{GS} = 20\text{k}\Omega$) (Note 1)	30	V
Gate to Source Voltage	$\pm 16\text{V}$	V
Continuous Drain Current	52	A
Pulsed Drain Current (Note 2)	390	A
Single Pulse Avalanche Energy (Note 4)	240	mj
Power Dissipation	89	W
Derate Above 25°C	0.71	$\text{W}/^\circ\text{C}$
Operating and Storage Temperature	-55 to 150	$^\circ\text{C}$
Maximum Temperature for Soldering		
Leads at 0.063in (1.6mm) from Case for 10s.	300	$^\circ\text{C}$
Package Body for 10s, See Techbrief 334	260	$^\circ\text{C}$

CAUTION: Stresses above those listed in "Absolute Maximum Ratings" may cause permanent damage to the device. This is a stress only rating and operation of the device at these or any other conditions above those indicated in the operational sections of this specification is not implied.

NOTE:

1. $T_J = 25^\circ\text{C}$ to 125°C .

Electrical Specifications $T_C = 25^\circ\text{C}$, Unless Otherwise Specified

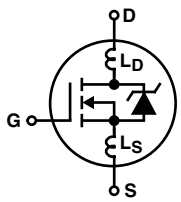
PARAMETER	SYMBOL	TEST CONDITIONS	MIN	TYP	MAX	UNITS		
Drain to Source Breakdown Voltage	BV_{DSS}	$I_D = 250\mu\text{A}$, $V_{GS} = 0\text{V}$	30	-	-	V		
Gate to Source Threshold Voltage	$V_{GS(TH)}$	$V_{GS} = V_{DS}$, $I_D = 250\mu\text{A}$	1	-	-	V		
Zero Gate Voltage Drain Current	I_{DSS}	$V_{DS} = 30\text{V}$, $V_{GS} = 0\text{V}$	-	-	25	μA		
		$V_{DS} = 24\text{V}$, $V_{GS} = 0\text{V}$, $T_C = 125^\circ\text{C}$	-	-	250	μA		
Gate to Source Leakage Current	I_{GSS}	$V_{GS} = \pm 16\text{V}$	-	-	100	nA		
Breakdown Voltage Temperature Coefficient	$\Delta V_{(BR)DSS} / \Delta T_J$	Reference to 25°C , $I_D = 1\text{mA}$	-	0.037	-	V		
Drain to Source On Resistance (Note 3)	$r_{DS(ON)}$	$I_D = 28\text{A}$, $V_{GS} = 10\text{V}$	-	-	0.019	Ω		
		$I_D = 23\text{A}$, $V_{GS} = 4.5\text{V}$	-	-	0.024	Ω		
Turn-On Delay Time	$t_{d(ON)}$	$V_{DD} = 15\text{V}$, $I_D \cong 34\text{A}$, $R_L = 0.441\Omega$, $V_{GS} = 4.5\text{V}$, $R_{GS} = 3.4\Omega$, $I_{g(REF)} = 3\text{mA}$	-	9	-	ns		
Rise Time	t_r		-	210	-	ns		
Turn-Off Delay Time (Note 3)	$t_{d(OFF)}$		-	20	-	ns		
Fall Time	t_f		-	54	-	ns		
Total Gate Charge	Q_g	$V_{DD} = 24\text{V}$, $I_D \cong 34\text{A}$, $V_{GS} = 4.5\text{V}$ (Figure 6)	-	-	50	nC		
Gate to Source Charge	Q_{gs}		-	-	14	nC		
Gate to Drain "Miller" Charge	Q_{gd}		-	-	28	nC		
Input Capacitance	C_{ISS}	$V_{DS} = 25\text{V}$, $V_{GS} = 0\text{V}$, $f = 1\text{MHz}$ (Figure 5)	-	1600	-	pF		
Output Capacitance	C_{OSS}		-	640	-	pF		
Reverse Transfer Capacitance	C_{RSS}		-	320	-	pF		
Internal Source Inductance	L_S	Measured From the Source Lead, 6mm (0.25in) From Package to Center of Die	Modified MOSFET Symbol Showing the Internal Devices Inductances 		-	7.5	-	nH
Internal Drain Inductance	L_D	Measured From the Drain-Lead, 6mm (0.25in) From Package to Center of Die			-	4.5	-	nH

HPLR3103, HPLU3103

Electrical Specifications $T_C = 25^\circ\text{C}$, Unless Otherwise Specified

PARAMETER	SYMBOL	TEST CONDITIONS	MIN	TYP	MAX	UNITS
Thermal Resistance Junction to Case	$R_{\theta JC}$		-	-	1.4	$^\circ\text{C/W}$
Thermal Resistance Junction to Ambient	$R_{\theta JA}$		-	-	110	$^\circ\text{C/W}$
		(PCB Mount Steady State)	-	-	50	$^\circ\text{C/W}$

Source to Drain Diode Specifications

PARAMETER	SYMBOL	TEST CONDITIONS	MIN	TYP	MAX	UNITS
Continuous Source to Drain Current	I_{SD}	MOSFET Symbol Showing The Integral Reverse P-N Junction Diode	-	-	52 (Note 1)	A
Pulsed Source to Drain Current (Note 2)	I_{SDM}		-	-	220	A
Source to Drain Diode Voltage (Note 3)	V_{SD}	$I_{SD} = 28\text{A}$	-	-	1.3	V
Reverse Recovery Time (Note 3)	t_{rr}	$I_{SD} = 34\text{A}$, $dI_{SD}/dt = 100\text{A}/\mu\text{s}$	-	81	120	ns
Reverse Recovered Charge (Note 3)	Q_{RR}	$I_{SD} = 34\text{A}$, $dI_{SD}/dt = 100\text{A}/\mu\text{s}$	-	210	310	nC

NOTES:

- Repetitive rating; pulse width limited by maximum junction temperature (See Figure 11).
- Pulse width $\leq 300\mu\text{s}$; duty cycle $\leq 2\%$.
- $V_{DD} = 15\text{V}$, starting $T_J = 25^\circ\text{C}$, $L = 300\mu\text{H}$, $R_G = 25\Omega$, peak $I_{AS} = 34\text{A}$, (Figure 10).

Typical Performance Curves

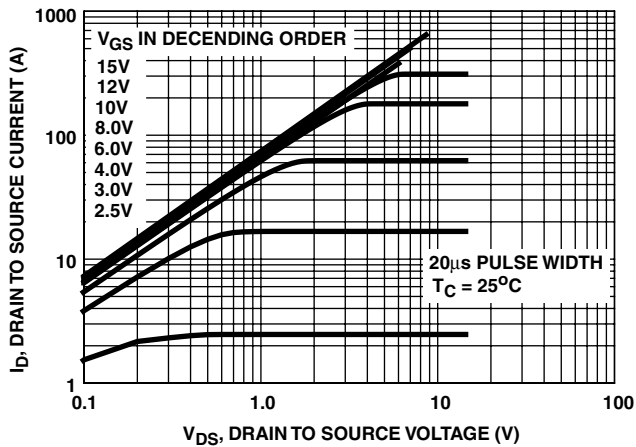

FIGURE 1. OUTPUT CHARACTERISTICS

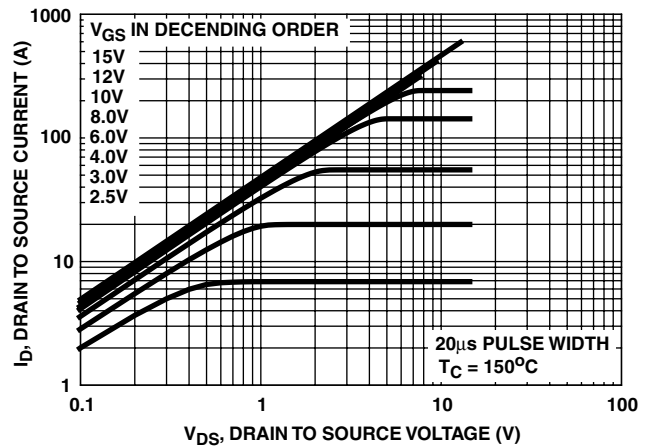

FIGURE 2. OUTPUT CHARACTERISTICS

Typical Performance Curves (Continued)

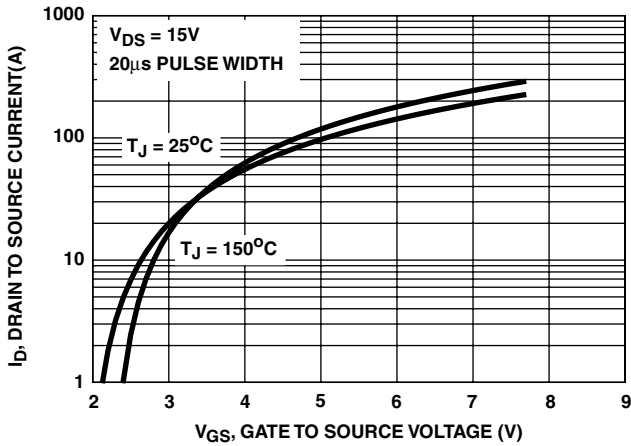

FIGURE 3. TRANSFER CHARACTERISTICS

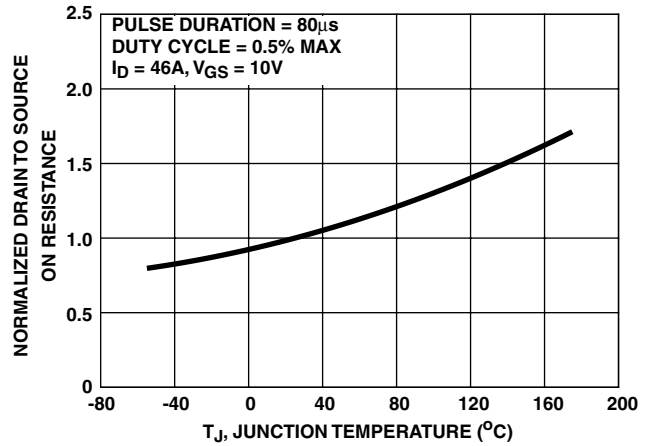

FIGURE 4. NORMALIZED DRAIN TO SOURCE ON RESISTANCE vs JUNCTION TEMPERATURE

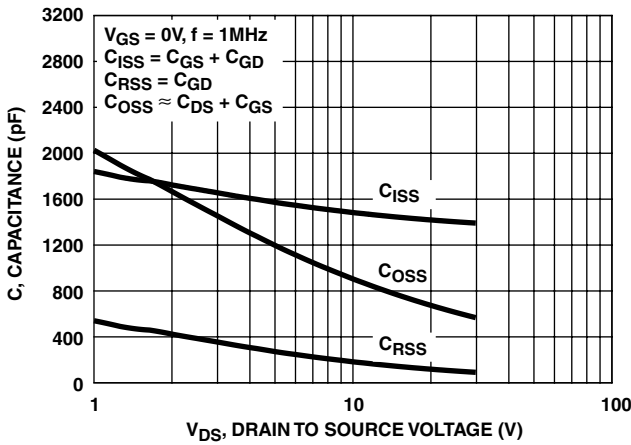

FIGURE 5. CAPACITANCE vs DRAIN TO SOURCE VOLTAGE

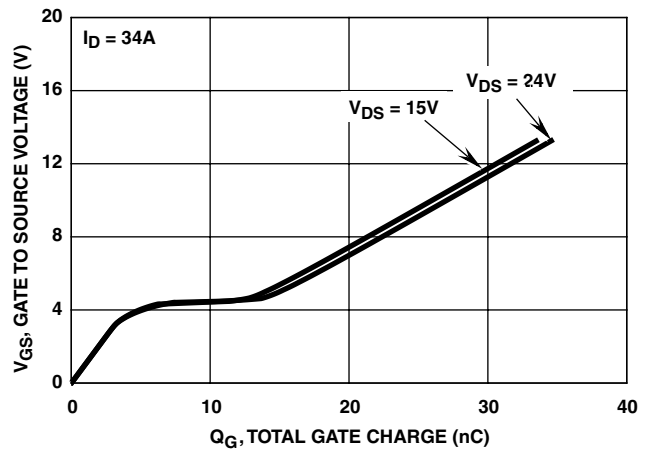

FIGURE 6. GATE CHARGE WAVEFORMS FOR CONSTANT GATE CURRENT

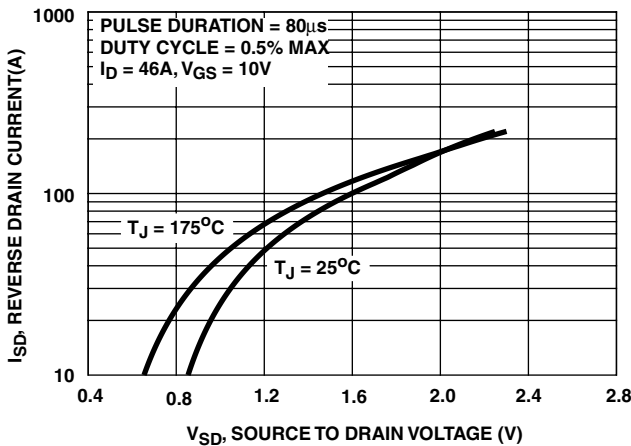

FIGURE 7. SOURCE TO DRAIN DIODE FORWARD VOLTAGE

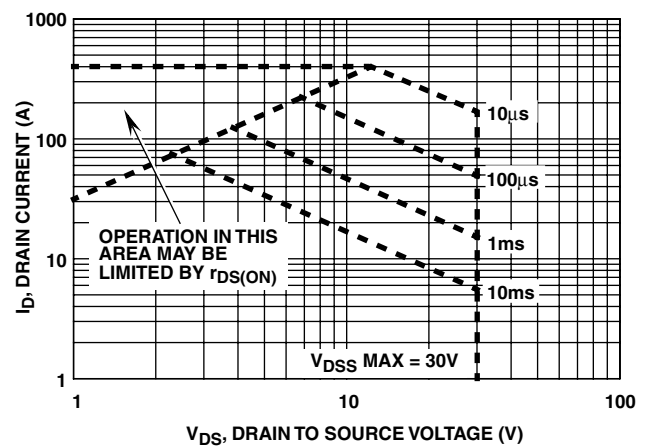

FIGURE 8. FORWARD BIAS SAFE OPERATING AREA

Typical Performance Curves (Continued)

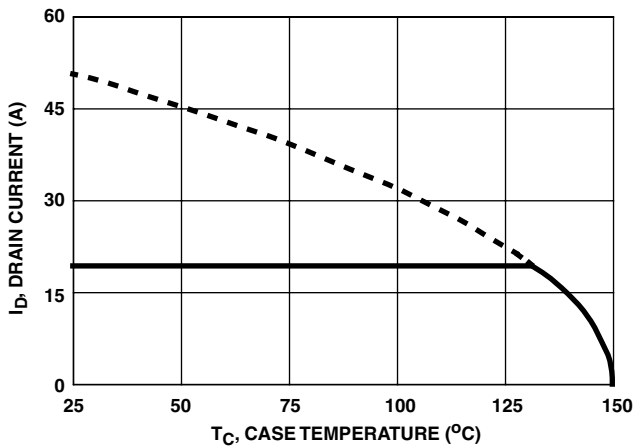

FIGURE 9. MAXIMUM CONTINUOUS DRAIN CURRENT vs CASE TEMPERATURE

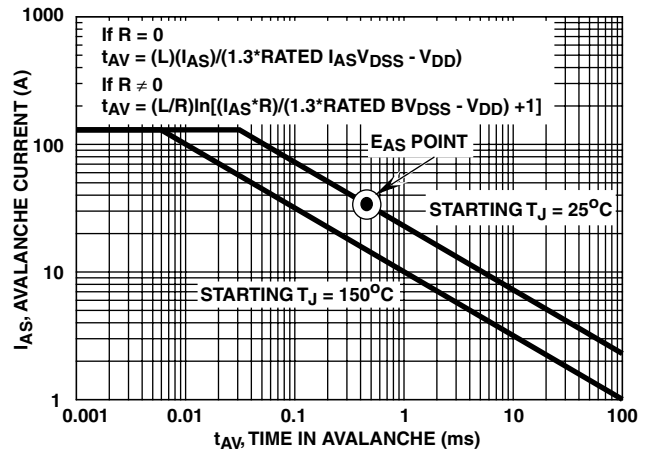

FIGURE 10. UNCLAMPED INDUCTIVE SWITCHING CAPABILITY

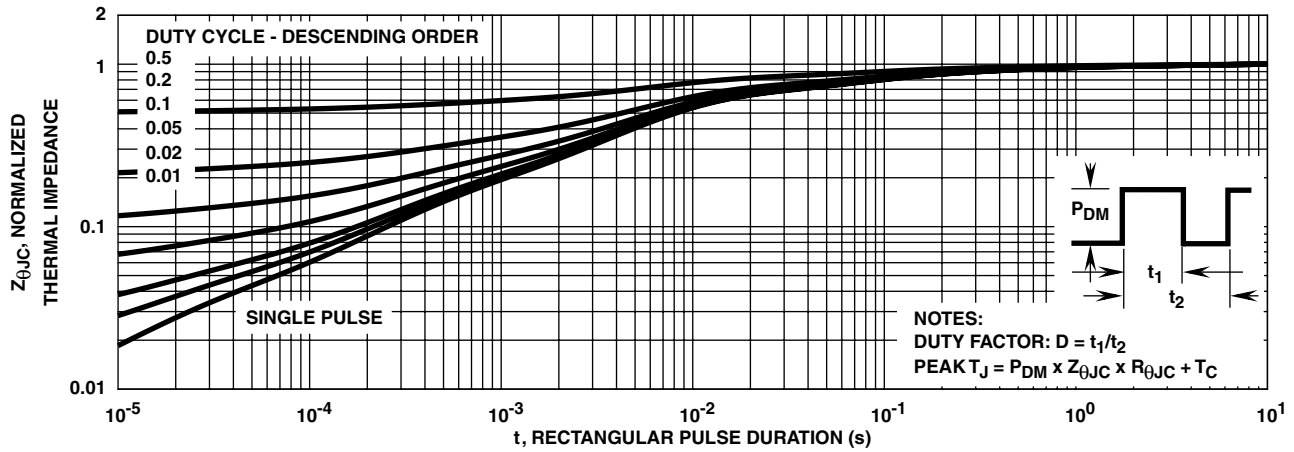

FIGURE 11. NORMALIZED MAXIMUM TRANSIENT THERMAL IMPEDANCE

Test Circuits and Waveforms

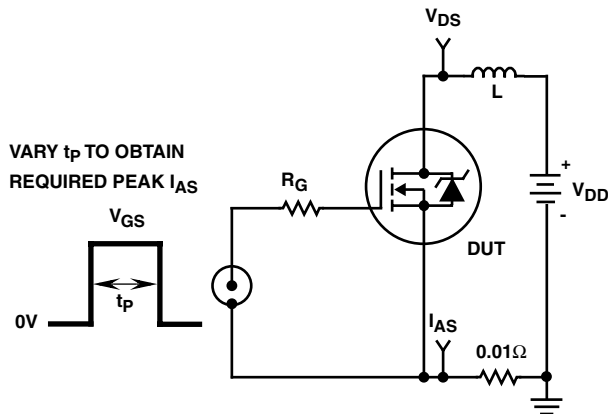

FIGURE 12. UNCLAMPED ENERGY TEST CIRCUIT

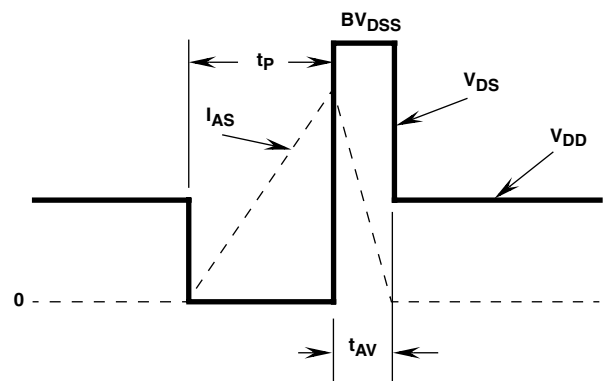

FIGURE 13. UNCLAMPED ENERGY WAVEFORMS

Test Circuits and Waveforms (Continued)

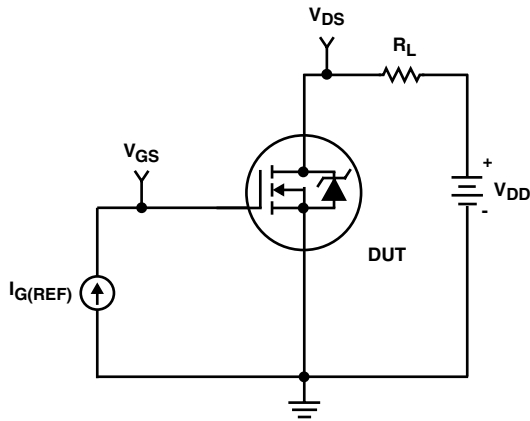

FIGURE 14. GATE CHARGE TEST CIRCUIT

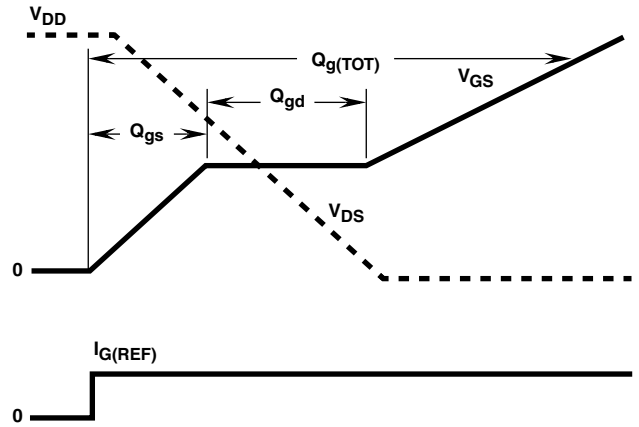

FIGURE 15. GATE CHARGE WAVEFORMS

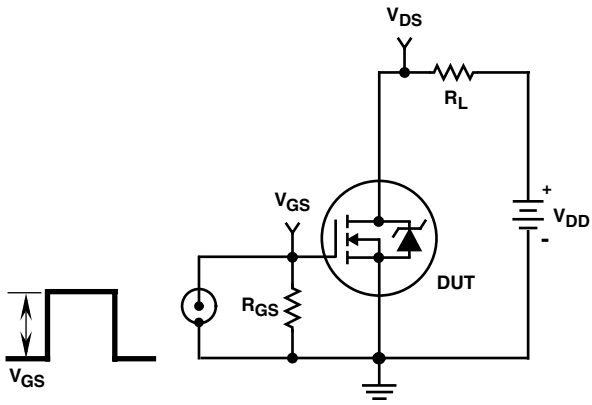

FIGURE 16. SWITCHING TIME TEST CIRCUIT

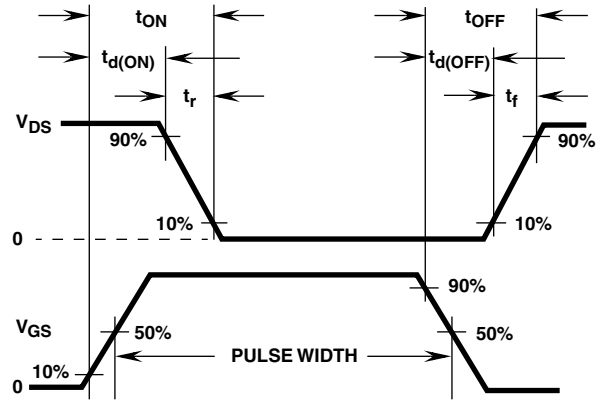

FIGURE 17. RESISTIVE SWITCHING WAVEFORMS

TRADEMARKS

The following are registered and unregistered trademarks Fairchild Semiconductor owns or is authorized to use and is not intended to be an exhaustive list of all such trademarks.

ACE _x TM	FAST [®]	OPTOLOGIC TM	SMART START TM	VCX TM
Bottomless TM	FAST _r TM	OPTOPLANAR TM	STAR*POWER TM	
CoolFET TM	FRFET TM	PACMAN TM	Stealth TM	
CROSSVOLT TM	GlobalOptoisolator TM	POP TM	SuperSOT TM -3	
DenseTrench TM	GTO TM	Power247 TM	SuperSOT TM -6	
DOMET TM	HiSeC TM	PowerTrench [®]	SuperSOT TM -8	
EcoSPARK TM	ISOPLANAR TM	QFET TM	SyncFET TM	
E ² CMOS TM	LittleFET TM	QS TM	TinyLogic TM	
EnSigna TM	MicroFET TM	QT Optoelectronics TM	TruTranslation TM	
FACT TM	MicroPak TM	Quiet Series TM	UHC TM	
FACT Quiet Series TM	MICROWIRE TM	SILENT SWITCHER [®]	UltraFET [®]	

STAR*POWER is used under license

DISCLAIMER

FAIRCHILD SEMICONDUCTOR RESERVES THE RIGHT TO MAKE CHANGES WITHOUT FURTHER NOTICE TO ANY PRODUCTS HEREIN TO IMPROVE RELIABILITY, FUNCTION OR DESIGN. FAIRCHILD DOES NOT ASSUME ANY LIABILITY ARISING OUT OF THE APPLICATION OR USE OF ANY PRODUCT OR CIRCUIT DESCRIBED HEREIN; NEITHER DOES IT CONVEY ANY LICENSE UNDER ITS PATENT RIGHTS, NOR THE RIGHTS OF OTHERS.

LIFE SUPPORT POLICY

FAIRCHILD'S PRODUCTS ARE NOT AUTHORIZED FOR USE AS CRITICAL COMPONENTS IN LIFE SUPPORT DEVICES OR SYSTEMS WITHOUT THE EXPRESS WRITTEN APPROVAL OF FAIRCHILD SEMICONDUCTOR CORPORATION.

As used herein:

1. Life support devices or systems are devices or systems which, (a) are intended for surgical implant into the body, or (b) support or sustain life, or (c) whose failure to perform when properly used in accordance with instructions for use provided in the labeling, can be reasonably expected to result in significant injury to the user.
2. A critical component is any component of a life support device or system whose failure to perform can be reasonably expected to cause the failure of the life support device or system, or to affect its safety or effectiveness.

PRODUCT STATUS DEFINITIONS

Definition of Terms

Datasheet Identification	Product Status	Definition
Advance Information	Formative or In Design	This datasheet contains the design specifications for product development. Specifications may change in any manner without notice.
Preliminary	First Production	This datasheet contains preliminary data, and supplementary data will be published at a later date. Fairchild Semiconductor reserves the right to make changes at any time without notice in order to improve design.
No Identification Needed	Full Production	This datasheet contains final specifications. Fairchild Semiconductor reserves the right to make changes at any time without notice in order to improve design.
Obsolete	Not In Production	This datasheet contains specifications on a product that has been discontinued by Fairchild semiconductor. The datasheet is printed for reference information only.