

ILC5062

SOT-23 Power Supply reset Monitor with 1% precision

Features

- All-CMOS design in SOT-23 or SC70 package
- A grade $\pm 1\%$ precision in Reset Detection
- Standard grade : $\pm 2\%$ precision in Reset Detection
- Only $1\mu\text{A}$ of I_q
- Over 2mA of sink current capability
- Built-in hysteresis of 5% of detection voltage
- Voltage options of 2.6, 2.7, 2.8, 2.9, 3.1, 4.4, and 4.6V fit most supervisory applications
- Active low push-pull output

Applications

- Microprocessor reset circuits
- Memory battery back-up circuitry
- Power-on reset circuits
- Portable and battery powered electronics

Description

All-CMOS voltage monitoring circuit in either a 3-lead SOT-23 or SC70 package offers the best performance in power consumption and accuracy.

The ILC5062 is available in a series of $\pm 1\%$ (A-grade) or 2% (standard grade) accurate trip voltages to fit most microprocessor applications. Even though its output can sink over 2mA, the device draws only $1\mu\text{A}$ in normal operation.

Additionally, a built-in hysteresis of 5% of detect voltage simplifies system design.

Block Diagram

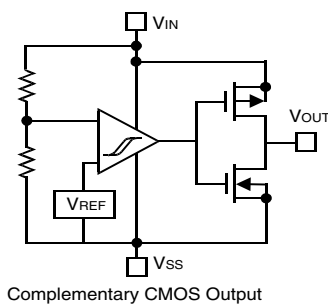

Pin-Package Configurations

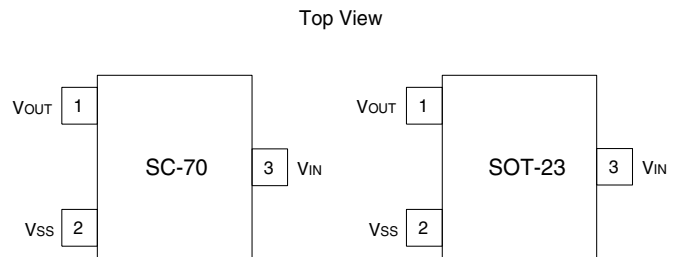

Absolute Maximum Ratings

Parameter	Symbol	Ratings	Units
Input Voltage	V_{IN}	12	V
Output Current	I_{OUT}	50	mA
Output Voltage	V_{OUT}	$V_{SS}-0.3 \sim V_{IN}+0.3$	V
Continuous Total Power Dissipation (SOT-23)	P_D	150	mW
Operating Ambient Temperature	T_{opr}	-30~+80	°C
Storage Temperature	T_{stg}	-40~+125	°C

Electrical Characterisitcs ILC5062 ($T_A=25^\circ\text{C}$)

Parameter	Symbol	Conditions	Min.	Typ.	Max.	Units
Detect Fail Voltage	V_{DF}	A grade	$V_{DF} \times 0.99$	V_{DF}	$V_{DF} \times 1.01$	V
Detect Fail Voltage	V_{DF}	Standard grade	$V_{DF} \times 0.98$	V_{DF}	$V_{DF} \times 1.02$	V
Hysteresis Range	V_{HYS}		$V_{DF} \times 0.02$	$V_{DF} \times 0.05$	$V_{DF} \times 0.08$	V
Supply Current	I_{SS}	$V_{IN} = 1.5V$ $V_{IN} = 2.0V$ $V_{IN} = 3.0V$ $V_{IN} = 4.0V$ $V_{IN} = 5.0V$		0.9 1.0 1.3 1.6 2.0	2.6 3.0 3.4 3.8 4.2	μA
Operating Voltage	V_{IN}	$V_{DF} = 2.1 \sim 6.0V$	1.5		10.0	V
Output Current	I_{OUT}	N-ch $V_{DS} = 0.5V$ $V_{IN} = 1.0V$ $V_{IN} = 2.0V$ $V_{IN} = 3.0V$ $V_{IN} = 4.0V$ $V_{IN} = 5.0V$ P-Ch $V_{DS} = 2.1V$ $V_{IN} = 8V$		2.2 7.7 10.1 11.5 13.0 -10		mA
Temperature Characteristics	$\Delta V_{DF}/(\Delta T_{opr} \cdot V_{DF})$	$-30^\circ\text{C} \leq T_{opr} \leq 80^\circ\text{C}$	-200	± 100	+200	ppm/°C
Delay Time (Release Voltage \rightarrow Output Inversion)	t_{DLY} (V_{DR} to V_{OUT} Inversion)				0.1	ms

Note1: An additional resistor between the V_{IN} pin and supply voltage may cause deterioration of the characteristics due to increasing of V_{DR} .

Note2: $V_{out} = \text{Gnd}$ when $1V < V_{IN} < 1.5V$

Note3: $I_{out} < 10\mu\text{A}$ when $V_{IN} < 1V$

Functional Description

The following designators 1~6 refer to the timing diagram below.

1. While the input voltage (V_{IN}) is higher than the detect voltage (V_{DF}), the output voltage at V_{OUT} pin equals the input voltage at V_{IN} pin.
2. When the input V_{IN} voltage falls lower than V_{DF} , V_{OUT} drops near ground voltage.
3. If the input voltage decreases below the minimum operating voltage (V_{MIN}), the V_{OUT} output voltage will be undefined.
4. During an increase of the input voltage from the V_{SS} voltage, V_{OUT} is undefined at the voltage below V_{MIN} . Exceeding the V_{MIN} level, the output stays at the ground level (V_{SS}) between the minimum operating voltage (V_{MIN}) and the detect release voltage (V_{DR}).
5. If the input voltage increases more than V_{DR} , the output voltage at V_{OUT} pin equals the input voltage at V_{IN} pin.
6. The difference between V_{DR} and V_{DF} is the hysteresis in the system.

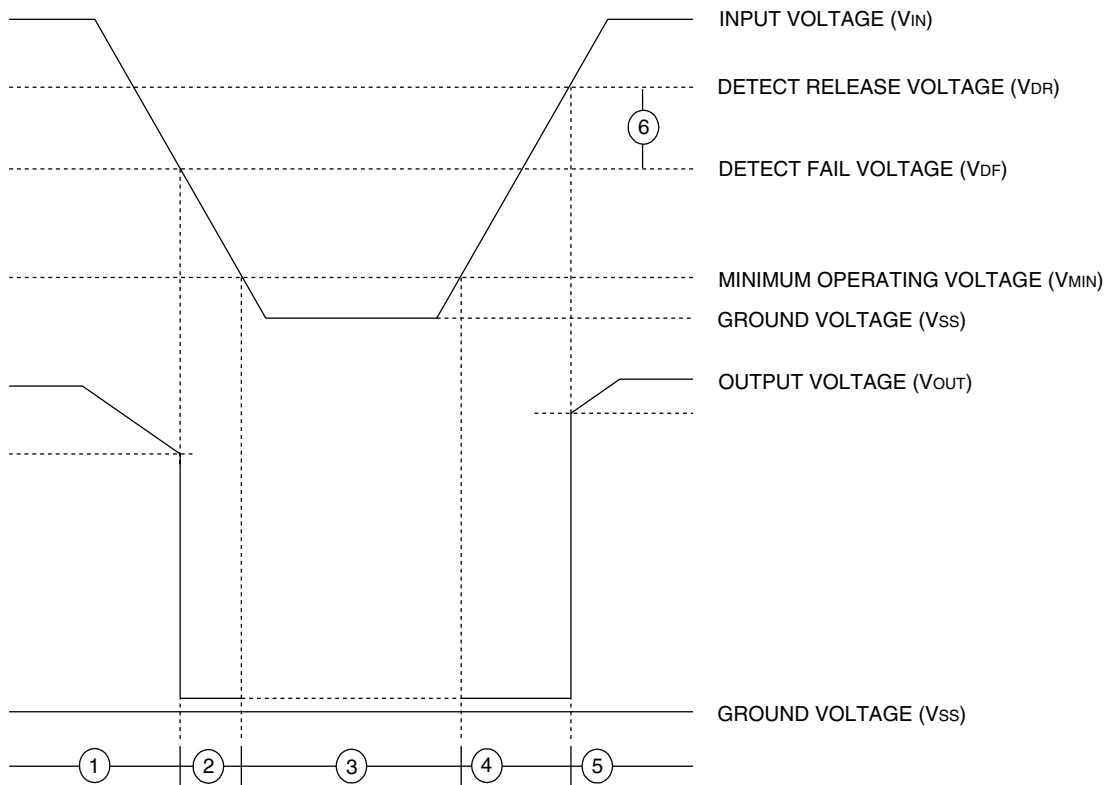

Typical Performance Characteristics - General conditions for all curves

Supply Current vs Input Voltage

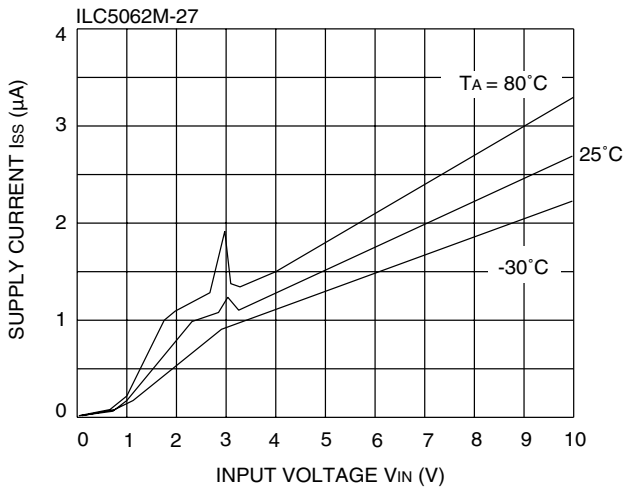

Supply Current vs Input Voltage

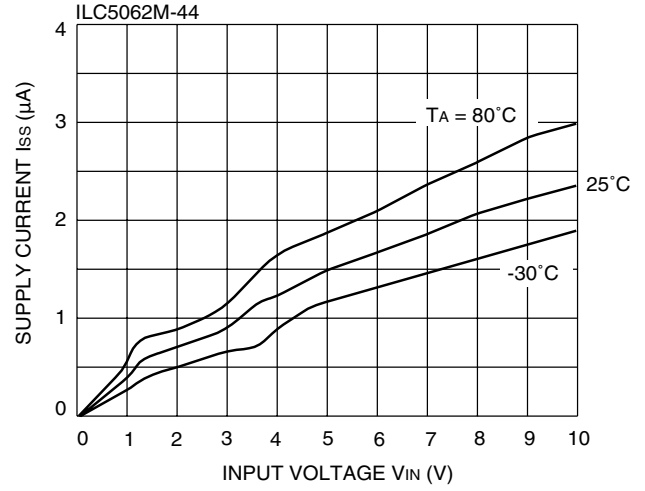

N-ch Driver Output Current vs Vds

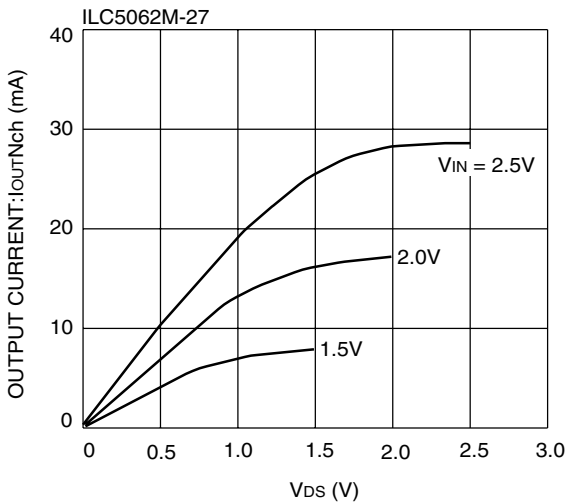

N-ch Driver Output Current vs Vds

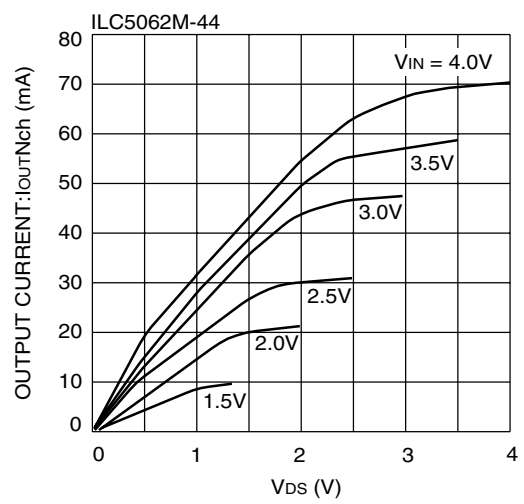

VOUT vs VIN

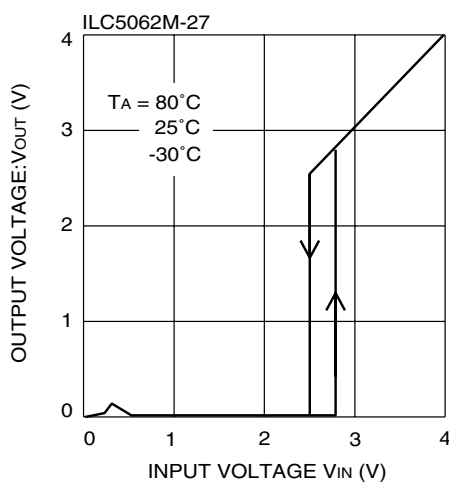

VOUT vs VIN

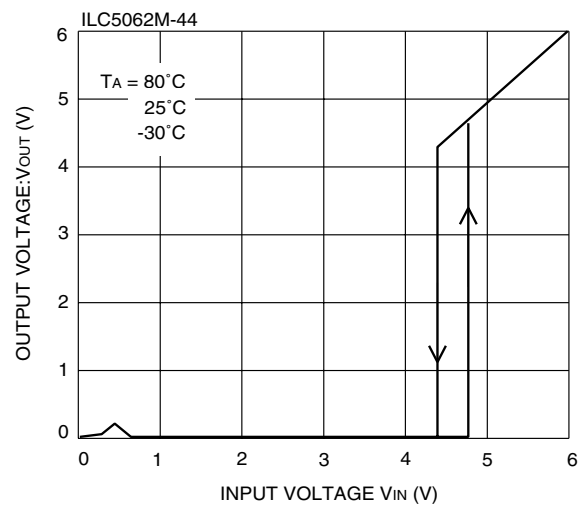

Typical Performance Characteristics - General conditions for all curves

N-ch Driver Output Current vs Input Voltage

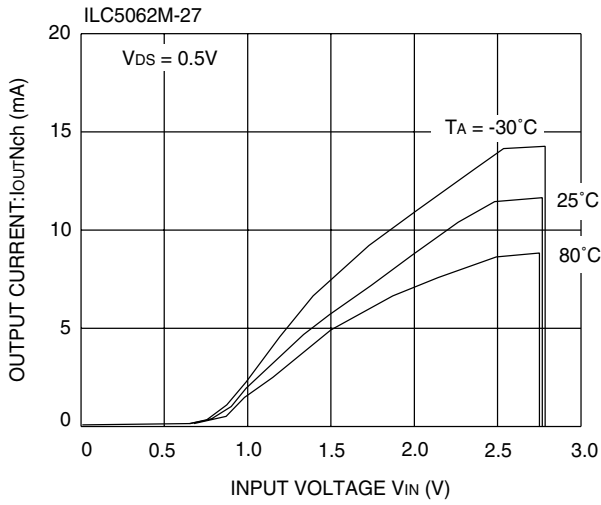

N-ch Driver Output Current vs Input Voltage

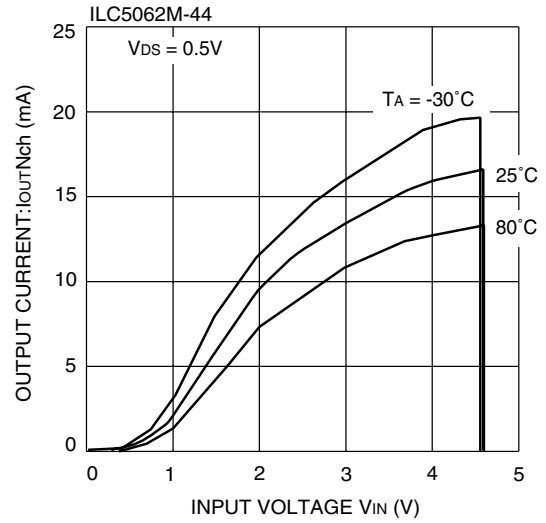

P_ch Driver Output Current vs Input Voltage

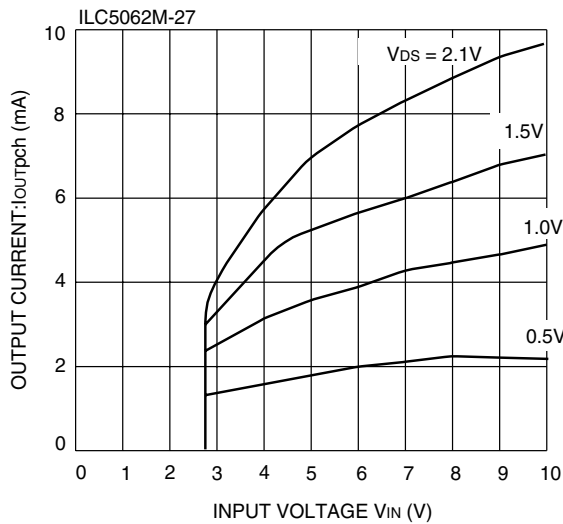

P_ch Driver Output Current vs Input Voltage

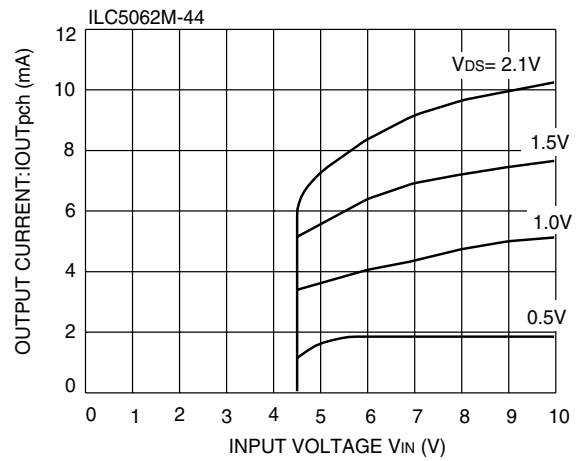

VDR and VDF vs Temperature

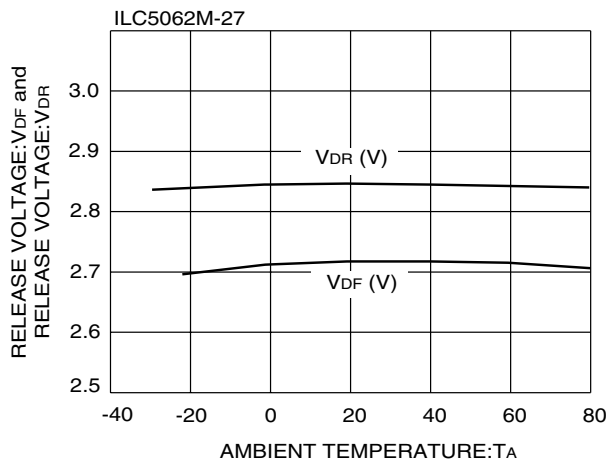

SOT-23

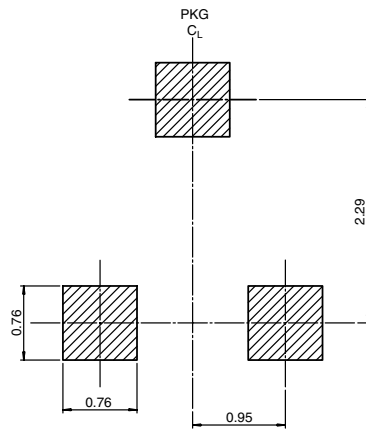
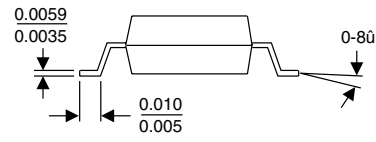
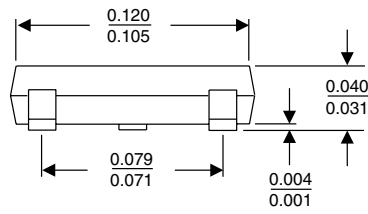
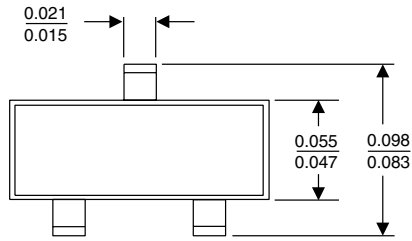

LAND PATTERN RECOMMENDATION

SC70

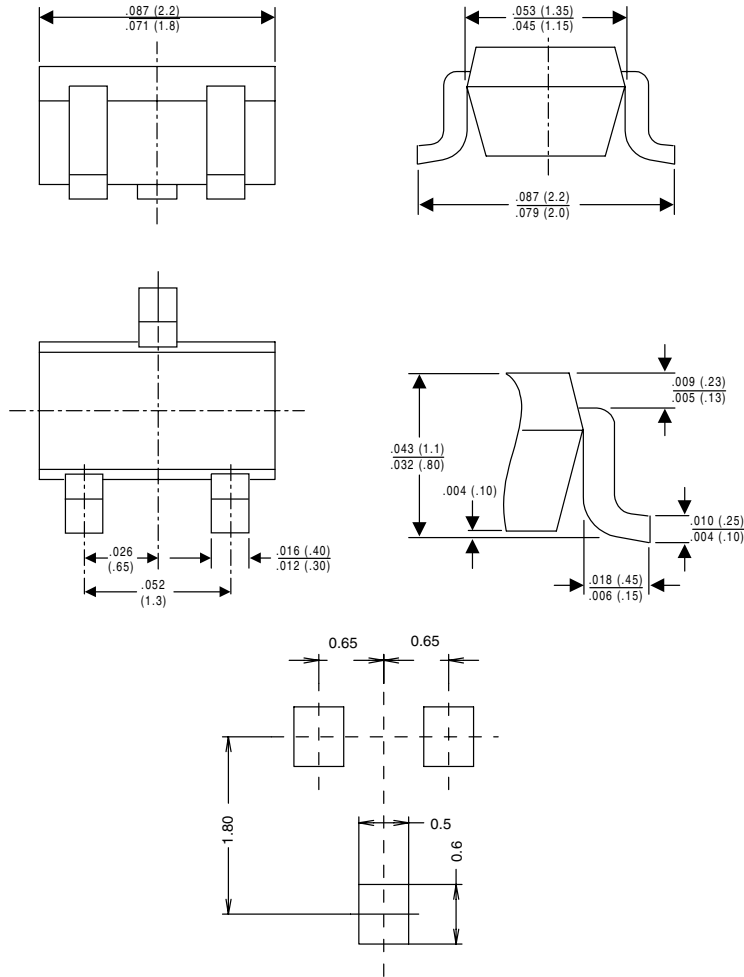

Land Pattern Recommendation

Ordering Information

PART NUMBER	TOP MARKING	RESET THRESHOLD (V)	OUTPUT TYPE	PACKAGE	PACKING METHOD
ILC5062AM23X	C3AY	2.3 ± 1 %	Push-Pull, active low	3-Pin, SOT23	3K units in T&R
ILC5062AM24X	C4AY	2.4 ± 1 %	Push-Pull, active low	3-Pin, SOT23	3K units in T&R
ILC5062AM25X	C5AY	2.5 ± 1 %	Push-Pull, active low	3-Pin, SOT23	3K units in T&R
ILC5062AM26X	C6AY	2.6 ± 1 %	Push-Pull, active low	3-Pin, SOT23	3K units in T&R
ILC5062AM27X	C7AY	2.7 ± 1 %	Push-Pull, active low	3-Pin, SOT23	3K units in T&R
ILC5062AM28X	C8AY	2.8 ± 1 %	Push-Pull, active low	3-Pin, SOT23	3K units in T&R
ILC5062AM29X	C9AY	2.9 ± 1 %	Push-Pull, active low	3-Pin, SOT23	3K units in T&R
ILC5062AM30X	D0AY	3.0 ± 1 %	Push-Pull, active low	3-Pin, SOT23	3K units in T&R
ILC5062AM31X	D1AY	3.1 ± 1 %	Push-Pull, active low	3-Pin, SOT23	3K units in T&R
ILC5062AM37X	D7AY	3.7 ± 1 %	Push-Pull, active low	3-Pin, SOT23	3K units in T&R
ILC5062AM44X	E4AY	4.4 ± 1 %	Push-Pull, active low	3-Pin, SOT23	3K units in T&R
ILC5062AM46X	E6AY	4.6 ± 1 %	Push-Pull, active low	3-Pin, SOT23	3K units in T&R
ILC5062M23X	C3Y	2.3 ± 2 %	Push-Pull, active low	3-Pin, SOT23	3K units in T&R
ILC5062M24X	C4Y	2.4 ± 2 %	Push-Pull, active low	3-Pin, SOT23	3K units in T&R
ILC5062M25X	C5Y	2.5 ± 2 %	Push-Pull, active low	3-Pin, SOT23	3K units in T&R
ILC5062M26X	C6Y	2.6 ± 2 %	Push-Pull, active low	3-Pin, SOT23	3K units in T&R
ILC5062M27X	C7Y	2.7 ± 2 %	Push-Pull, active low	3-Pin, SOT23	3K units in T&R
ILC5062M28X	C8Y	2.8 ± 2 %	Push-Pull, active low	3-Pin, SOT23	3K units in T&R
ILC5062M29X	C9Y	2.9 ± 2 %	Push-Pull, active low	3-Pin, SOT23	3K units in T&R
ILC5062M30X	D0Y	3.0 ± 2 %	Push-Pull, active low	3-Pin, SOT23	3K units in T&R
ILC5062M31X	D1Y	3.1 ± 2 %	Push-Pull, active low	3-Pin, SOT23	3K units in T&R
ILC5062M37X	D7Y	3.7 ± 2 %	Push-Pull, active low	3-Pin, SOT23	3K units in T&R
ILC5062M44X	E4Y	4.4 ± 2 %	Push-Pull, active low	3-Pin, SOT23	3K units in T&R
ILC5062M46X	E6Y	4.6 ± 2 %	Push-Pull, active low	3-Pin, SOT23	3K units in T&R

Note 1: Last digit in the "Top Marking" information (represented by "Y" in the above table) represents internal assembly lot number

Note 2: Orientation of Tape & Reeled devices is Right.

Ordering Information

PART NUMBER	TOP MARKING	RESET THRESHOLD (V)	OUTPUT TYPE	PACKAGE	PACKING METHOD
ILC5062AIC23X	C3AY	2.3 ± 1 %	Push-Pull, active low	3-Pin, SC70	3K units in T&R
ILC5062AIC24X	C4AY	2.4 ± 1 %	Push-Pull, active low	3-Pin, SC70	3K units in T&R
ILC5062AIC25X	C5AY	2.5 ± 1 %	Push-Pull, active low	3-Pin, SC70	3K units in T&R
ILC5062AIC26X	C6AY	2.6 ± 1 %	Push-Pull, active low	3-Pin, SC70	3K units in T&R
ILC5062AIC27X	C7AY	2.7 ± 1 %	Push-Pull, active low	3-Pin, SC70	3K units in T&R
ILC5062AIC28X	C8AY	2.8 ± 1 %	Push-Pull, active low	3-Pin, SC70	3K units in T&R
ILC5062AIC29X	C9AY	2.9 ± 1 %	Push-Pull, active low	3-Pin, SC70	3K units in T&R
ILC5062AIC30X	D0AY	3.0 ± 1 %	Push-Pull, active low	3-Pin, SC70	3K units in T&R
ILC5062AIC31X	D1AY	3.1 ± 1 %	Push-Pull, active low	3-Pin, SC70	3K units in T&R
ILC5062AIC37X	D7AY	3.7 ± 1 %	Push-Pull, active low	3-Pin, SC70	3K units in T&R
ILC5062AIC44X	E4AY	4.4 ± 1 %	Push-Pull, active low	3-Pin, SC70	3K units in T&R
ILC5062AIC46X	E6AY	4.6 ± 1 %	Push-Pull, active low	3-Pin, SC70	3K units in T&R
ILC5062IC23X	C3Y	2.3 ± 2 %	Push-Pull, active low	3-Pin, SC70	3K units in T&R
ILC5062IC24X	C4Y	2.4 ± 2 %	Push-Pull, active low	3-Pin, SC70	3K units in T&R
ILC5062IC25X	C5Y	2.5 ± 2 %	Push-Pull, active low	3-Pin, SC70	3K units in T&R
ILC5062IC26X	C6Y	2.6 ± 2 %	Push-Pull, active low	3-Pin, SC70	3K units in T&R
ILC5062IC27X	C7Y	2.7 ± 2 %	Push-Pull, active low	3-Pin, SC70	3K units in T&R
ILC5062IC28X	C8Y	2.8 ± 2 %	Push-Pull, active low	3-Pin, SC70	3K units in T&R
ILC5062IC29X	C9Y	2.9 ± 2 %	Push-Pull, active low	3-Pin, SC70	3K units in T&R
ILC5062IC30X	D0Y	3.0 ± 2 %	Push-Pull, active low	3-Pin, SC70	3K units in T&R
ILC5062IC31X	D1Y	3.1 ± 2 %	Push-Pull, active low	3-Pin, SC70	3K units in T&R
ILC5062IC37X	D7Y	3.7 ± 2 %	Push-Pull, active low	3-Pin, SC70	3K units in T&R
ILC5062IC44X	E4Y	4.4 ± 2 %	Push-Pull, active low	3-Pin, SC70	3K units in T&R
ILC5062IC46X	E6Y	4.6 ± 2 %	Push-Pull, active low	3-Pin, SC70	3K units in T&R

Note 1: Last digit in the "Top Marking" information (represented by "Y" in the above table) represents internal assembly lot number

Note 2: Orientation of Tape & Reeled devices is Right.

DISCLAIMER

FAIRCHILD SEMICONDUCTOR RESERVES THE RIGHT TO MAKE CHANGES WITHOUT FURTHER NOTICE TO ANY PRODUCTS HEREIN TO IMPROVE RELIABILITY, FUNCTION OR DESIGN. FAIRCHILD DOES NOT ASSUME ANY LIABILITY ARISING OUT OF THE APPLICATION OR USE OF ANY PRODUCT OR CIRCUIT DESCRIBED HEREIN; NEITHER DOES IT CONVEY ANY LICENSE UNDER ITS PATENT RIGHTS, NOR THE RIGHTS OF OTHERS.

LIFE SUPPORT POLICY

FAIRCHILD'S PRODUCTS ARE NOT AUTHORIZED FOR USE AS CRITICAL COMPONENTS IN LIFE SUPPORT DEVICES OR SYSTEMS WITHOUT THE EXPRESS WRITTEN APPROVAL OF THE PRESIDENT OF FAIRCHILD SEMICONDUCTOR CORPORATION. As used herein:

1. Life support devices or systems are devices or systems which, (a) are intended for surgical implant into the body, or (b) support or sustain life, and (c) whose failure to perform when properly used in accordance with instructions for use provided in the labeling, can be reasonably expected to result in a significant injury of the user.
2. A critical component in any component of a life support device or system whose failure to perform can be reasonably expected to cause the failure of the life support device or system, or to affect its safety or effectiveness.