

High Bandwidth Triple Video Filters with Buffered Outputs for RGB or YUV

GENERAL DESCRIPTION

The ML6426 are a family of triple video filters with buffered outputs. There are several versions of the ML6426, each with different passband cut-off frequencies of 6.7MHz, 12MHz, 15MHz, 24MHz, 30MHz, 36MHz, and 48MHz. Each channel contains a 4th-order Butterworth lowpass reconstruction video filter. The filter is optimized for minimum overshoot and flat group delay and guaranteed differential gain and phase at the outputs of the integrated cable drivers.

All input signals from DACs are AC coupled into the ML6426. All channels have DC restore circuitry to clamp the DC input levels during video H-sync, using an output feedback clamp. An external H-sync signal is required for this purpose.

All outputs must be AC coupled into their loads. Each output can drive 2V_{p,p} into a 150Ω load. All channels have a gain of 2 (6dB) at 1V_{p,p} input levels.

FEATURES

- 5V ±10% operation
- RGB/YUV filters for ATSC Digital Television VESA Standard
- 2:1 Mux Inputs for multiple RGB/YUV inputs
- Triple Reconstruction Filter options for 6.7, 12, 15, 24, 30, 36, and 48MHz to handle various line rates
- Multiple ML6426 outputs can be paralleled to drive RGB/YUV outputs at different frequencies for various line rates by means of Disable/Enable pin.
- 6dB drivers and sync tip clamps for DC restore
- DC restore with minimal tilt
- 0.4% differential gain on all channels
0.4° differential phase on all channels
0.8% total harmonic distortion on all channels
- 2kV ESD protection

BLOCK DIAGRAM

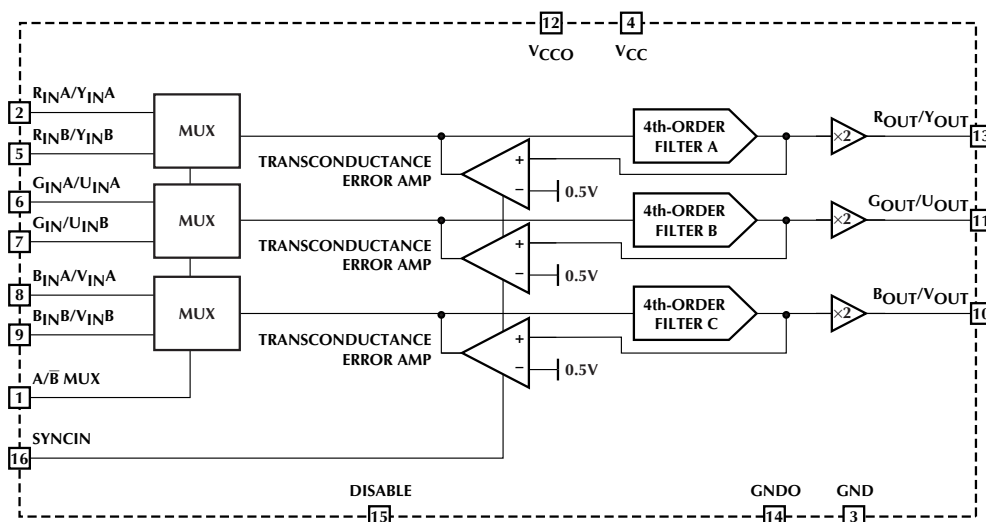

	ML6426-1	ML6426-2	ML6426-3	ML6426-4	ML6426-5	ML6426-6	ML6426-15
Filter A	6.7MHz	12MHz	24MHz	30MHz	36MHz	48MHz	15MHz
Filter B	6.7MHz	12MHz	24MHz	30MHz	36MHz	48MHz	15MHz
Filter C	6.7MHz	12MHz	24MHz	30MHz	36MHz	48MHz	15MHz

ML6426

PIN CONFIGURATION

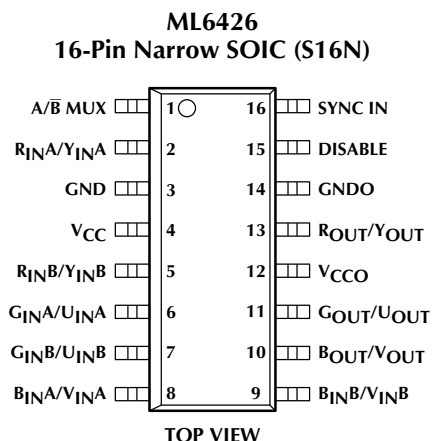

PIN DESCRIPTION

PIN	NAME	FUNCTION	PIN	NAME	FUNCTION
1	A/ \bar{B} MUX	Logic input pin to select between Bank <A> and Bank video inputs. This pin is internally pulled high.	8	B _{IN} A/V _{IN} A	Unfiltered analog B- or V-channel input for Bank <A>. Sync must be provided at SYNC IN pin.
2	R _{IN} A/Y _{IN} A	Unfiltered analog R- or Y-channel input for Bank <A>. Sync must be provided at SYNC IN pin.	9	B _{IN} B/V _{IN} B	Unfiltered analog B- or V-channel input for Bank . Sync must be provided at SYNC IN pin.
3	GND	Analog ground	10	B _{OUT}	Analog B or V-channel output
4	V _{CC}	Analog 5V supply	11	G _{OUT}	Analog G or U-channel output
5	R _{IN} B/Y _{IN} B	Unfiltered analog R- or Y-channel input for Bank . Sync must be provided at SYNC IN pin.	12	V _{CCO}	5V power supply for output buffers
6	G _{IN} A/U _{IN} A	Unfiltered analog G- or U-channel input for Bank <A>. Sync must be provided at SYNC IN pin.	13	R _{OUT}	Analog R or Y-channel output
7	G _{IN} B/U _{IN} B	Unfiltered analog G- or U-channel input for Bank . Sync must be provided at SYNC IN pin.	14	GNDO	Analog ground
			15	DISABLE	Disable/Enable pin. Turns the chip off when logic high. Internally pulled low.
			16	SYNC IN	Input for an external H-sync logic signal for filter channels. CMOS level input. Active High.

ABSOLUTE MAXIMUM RATINGS

Absolute maximum ratings are those values beyond which the device could be permanently damaged. Absolute maximum ratings are stress ratings only and functional device operation is not implied.

V_{CC} -0.3V to 7V
 Junction Temperature 150°C
 ESD >2000V
 Analog and Digital I/O GND -0.3V to $V_{CC} + 0.3V$

Storage Temperature Range -65°C to 150°C
 Lead Temperature (Soldering, 10 sec) 260°C
 Thermal Resistance (θ_{JA}) 100°C/W

OPERATING CONDITIONS

Temperature Range 0°C to 70°C
 V_{CC} Range 4.5V to 5.5V

ELECTRICAL CHARACTERISTICS

Unless otherwise specified, $V_{CC} = 5V \pm 10\%$, $T_A =$ Operating Temperature Range (Note 1)

SYMBOL	PARAMETER	CONDITIONS	MIN	TYP	MAX	UNITS
GENERAL						
I_{CC}	Supply Current	No Load ($V_{CC}=5.5V$)		52	80	mA
A_V	Low Frequency Gain (R, G, B)	$V_{IN} = 100mV_{P-P}$ at 100KHz	5.34	6.0	6.65	dB
V_{OUT}	Output Level during Sync (R, G, B,)	DURING SYNC	0.7	0.9	1.1	V
	Output Capability	RL = 150W, AC-coupled@1MHz	2			VP-P
t_{CLAMP}	Clamp Response Time	Settled to Within 10mV, $C_{IN} = 0.1\mu F$		10		ms
V_I	Input Signal Dynamic Range (R, G, B,)	AC Coupled		1.4		V_{P-P}
OS	Peak Overshoot (R, G, B,)	$2V_{P-P}$ Output Pulse		4.3		%
C_L	Output Load Capacitance (R, G, B,)	All Outputs			35	pF
	Output Load Drive Capability, per Pin (YUV or RGB Outputs)	One Load is 150Ω		2		loads
dG	Differential Gain (R, G, B,)	All Outputs at $f_C/2$		0.4		%
dφ	Differential Phase (R, G, B,)	All Outputs at $f_C/2$		0.4		°
T_{HD}	Output Distortion (R, G, B,)	$V_{OUT} = 2V_{P-P}$ at 1 MHz		0.8		%
PSRR	PSRR (R, G, B,)	$0.5V_{P-P}$ (100kHz) at V_{CC}		35		dB
I_{SC}	Output Short Circuit Current (R, G, B,)	Note 2		120		mA
V_{IH}	Input Voltage Logic High	DISABLE, SYNCIN	2.5			V
V_{IL}	Input Voltage Logic Low	DISABLE, SYNCIN			1.0	V
T_{MUX}	Input Mux Data Valid Time	A/\bar{B} Mux Pin Valid High or Low		2		μs

6.7MHz FILTER: ML6426-1

f_{1dB}	-1dB Bandwidth Flatness (R, G, B,)	25°C	4.0	4.8		MHz
f_c	-3dB Bandwidth Flatness (R, G, B,)	25°C	6.0	6.7	7.3	MHz
$f_{0.8fc}$	0.8 x f_C Attenuation			1.5		dB
f_{SB}	StopBand Rejection (All Channels $\geq 4 f_C$)	$f_{IN} \geq 4 f_C$, Note 3	-38	-42		dB
NOISE	Output Noise (R, G, B,)	Fullband		1.0		mV _{RMS}
X_{TALK}	Crosstalk	Input of $0.5V_{P-P}$ at 1 MHz Between any two Channels		-55		dB
X_{TALK}	A/\bar{B} MUX Crosstalk	Input of $0.5V_{P-P}$ at 3.58/4.43MHz		-54		dB

ML6426

ELECTRICAL CHARACTERISTICS (Continued)

SYMBOL	PARAMETER	CONDITIONS	MIN	TYP	MAX	UNITS
6.7MHZ FILTER: ML6426-1 (continued)						
T_{PD}	Group Delay (R, G, B,)	100kHz		70		ns
ΔT_{PD}	Group Delay Deviation from Flatness (R, G, B,)	to 3.58MHz		4.0		ns
		to 4.43MHz		8.0		ns
		to 10MHz		9		ns
2MHz FILTER: ML6426-2						
f_{1dB}	-1dB Bandwidth Flatness (R, G, B,)	25°C	7.8	9.2		MHz
f_c	-3dB Bandwidth Flatness (R, G, B,)	25°C	10.8	12	13.2	MHz
$f_{0.8fc}$	0.8 x f_c Attenuation			1.2		dB
f_{SB}	StopBand Rejection (All Channels $\geq 4 f_c$)	$f_{IN} \geq 4 f_c$, Note 3		-40		dB
NOISE	Output Noise (R, G, B,)	Fullband		1		mV _{RMS}
X_{TALK}	Crosstalk	Input of 0.5V _{p-p} at 1 MHz Between any two Channels		-55		dB
X_{TALK}	A/ \bar{B} MUX Crosstalk	Input of 0.5V _{p-p} at 3.58/4.43MHz		-54		dB
T_{PD}	Group Delay (R, G, B,)	100kHz		40		ns
ΔT_{PD}	Group Delay Deviation from Flatness (R, G, B,)	to 3.58MHz		1		ns
		to 4.43MHz		1		ns
		to 10MHz		7		ns
24MHz FILTER: ML6426-3						
f_{1dB}	-1dB Bandwidth Flatness (R, G, B,)	25°C	13.6	16		MHz
f_c	-3dB Bandwidth Flatness (R, G, B,)	25°C	21.6	24	26.4	MHz
$f_{0.8fc}$	0.8 x f_c Attenuation			1.7		dB
f_{SB}	StopBand Rejection (All Channels $\geq 4 f_c$)	$f_{IN} \geq 4 f_c$, Note 3		-40		dB
NOISE	Output Noise (R, G, B,)	Fullband		1.0		mV _{RMS}
X_{TALK}	Crosstalk	Input of 0.5V _{p-p} at 1 MHz Between any two Channels		-55		dB
X_{TALK}	A/ \bar{B} MUX Crosstalk	Input of 0.5V _{p-p} at 3.58/4.43MHz		-54		dB
T_{PD}	Group Delay (R, G, B,)	100kHz		22		ns
ΔT_{PD}	Group Delay Deviation from Flatness (R, G, B,)	to 3.58MHz		1		ns
		to 4.43MHz		1		ns
		to 10MHz		2		ns
30MHz FILTER: ML6426-4						
f_{1dB}	-1dB Bandwidth Flatness (R, G, B,)	25°C	15.3	18		MHz
f_c	-3dB Bandwidth Flatness (R, G, B,)	25°C	27	30	33	MHz
$f_{0.8fc}$	0.8 x f_c Attenuation			1.7		dB
f_{SB}	StopBand Rejection (All Channels $\geq 4 f_c$)	$f_{IN} \geq 4 f_c$, Note 3		-40		dB
NOISE	Output Noise (R, G, B,)	Fullband		1.0		mV _{RMS}

ELECTRICAL CHARACTERISTICS (Continued)

SYMBOL	PARAMETER	CONDITIONS	MIN	TYP	MAX	UNITS
30MHz FILTER: ML6426-4 (Continued)						
X _{TALK}	Crosstalk	Input of 0.5V _{p,p} at 1 MHz Between any two Channels		-55		dB
X _{TALK}	A \bar{B} MUX Crosstalk	Input of 0.5V _{p,p} at 3.58/4.43MHz		-54		dB
T _{PD}	Group Delay (R, G, B _r)	100kHz		18		ns
Δ T _{PD}	Group Delay Deviation from Flatness (R, G, B _r)	to 10MHz		0.5		ns
		to 27MHz		2		ns
36MHz FILTER: ML6426-5						
f _{1dB}	-1dB Bandwidth Flatness (R, G, B _r)	25°C	17	20		MHz
f _c	-3dB Bandwidth Flatness (R, G, B _r)	25°C	32.4	36	39.6	MHz
f _{0.8fc}	0.8 x f _c Attenuation			2		dB
f _{SB}	StopBand Rejection (All Channels \geq 4 f _c)	f _{IN} \geq 4 f _c , Note 3		-40		dB
NOISE	Output Noise (R, G, B _r)	Fullband		1.0		mV _{RMS}
X _{TALK}	Crosstalk	Input of 0.5V _{p,p} at 1 MHz Between any two Channels		-55		dB
X _{TALK}	A \bar{B} MUX Crosstalk	Input of 0.5V _{p,p} at 3.58/4.43MHz		-54		dB
T _{PD}	Group Delay (R, G, B _r)	100kHz		17		ns
Δ T _{PD}	Group Delay Deviation from Flatness (R, G, B _r)	to 10MHz		0.5		ns
		to 30MHz		4		ns
48MHz FILTER: ML6426-6						
f _{1dB}	-1dB Bandwidth Flatness (R, G, B _r)	25°C	25.5	30		MHz
f _c	-3dB Bandwidth Flatness (R, G, B _r)	25°C	43.2	48	52.8	MHz
f _{0.8fc}	0.8 x f _c Attenuation			1.2		dB
f _{SB}	StopBand Rejection (All Channels \geq 4 f _c)	f _{IN} \geq 4 f _c , Note 3		-40		dB
NOISE	Output Noise (R, G, B _r)	Fullband		1.0		mV _{RMS}
X _{TALK}	Crosstalk	Input of 0.5V _{p,p} at 1 MHz Between any two Channels		-55		dB
X _{TALK}	A \bar{B} MUX Crosstalk	Input of 0.5V _{p,p} at 3.58/4.43MHz		-54		dB
T _{PD}	Group Delay (R, G, B _r)	100kHz		16		ns
Δ T _{PD}	Group Delay Deviation from Flatness (R, G, B _r)	to 10MHz		0.5		ns
		to 40MHz		2		ns

Note 1. Limits are guaranteed by 100% testing, sampling, or correlation with worst case test conditions.

Note 2. Sustained short circuit protection limited to 10 seconds.

Note 3. 38dB is based on tester noise limits.

ML6426

FUNCTIONAL DESCRIPTION

The ML6426 is a triple monolithic continuous time video filter designed for reconstructing video signals from an YUV/RGB video D/A source. The ML6426 is intended for use in AC coupled input and output applications.

The filters approximate a 4th-order Butterworth characteristic with an optimization toward low overshoot and flat group delay. All outputs are capable of driving $2V_{p-p}$ into AC coupled 150Ω video loads, with up to $35pF$ of load capacitance. All outputs are capable of driving a 75Ω load at $1V_{p-p}$.

All channels are clamped during sync to establish the appropriate output voltage swing range (DC restore). Thus the input coupling capacitors do not behave according to the conventional RC time constant. In most applications, the ML6426's input coupling capacitors are only $0.1\mu F$.

An external CMOS compatible H_{SYNC} pulse is required which is Active High on the SYNC IN Pin. See Figure 2.

During sync, the feedback clamp sources/sinks current to restore the DC level. The net result is that the average input current is zero. Any change in the input coupling capacitors' value will linearly affect the clamp response times.

Each channel is essentially tilt-free. Each input is clamped by a feedback amp which responds to the output during sync.

The ML6426 is robust and stable under all stated load and input conditions. Bypassing both V_{CC} pins directly to ground ensures this performance.

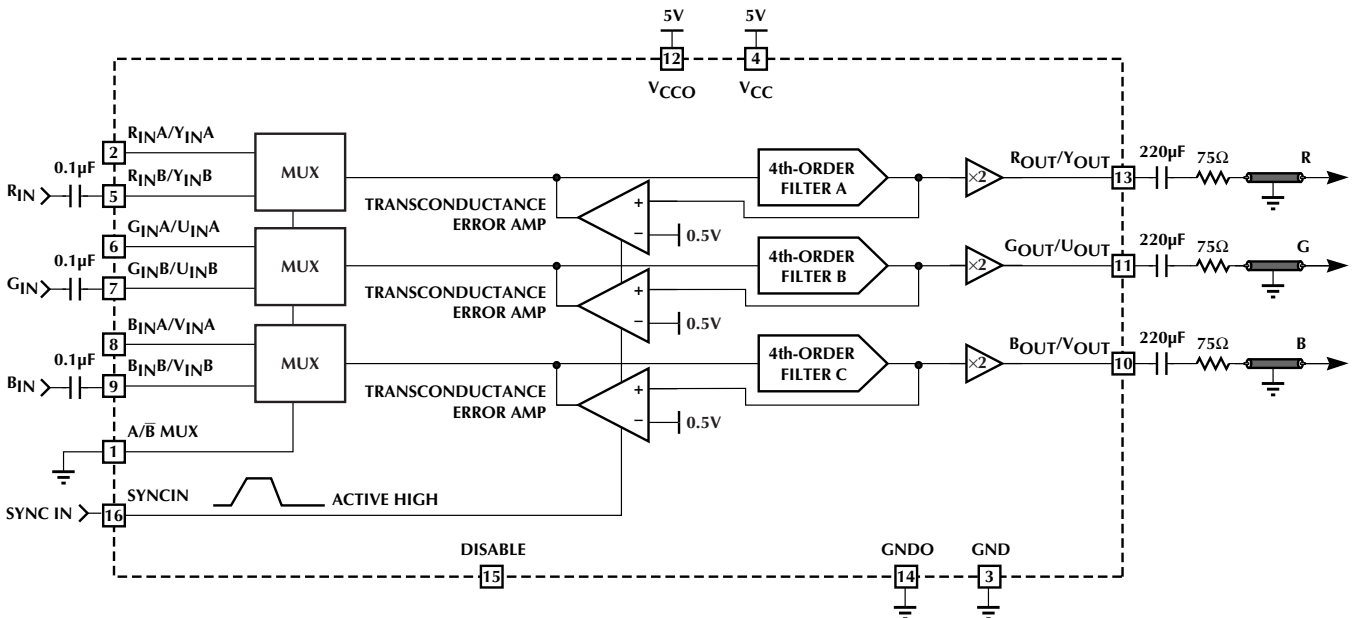

Figure 1. Typical Application Schematic

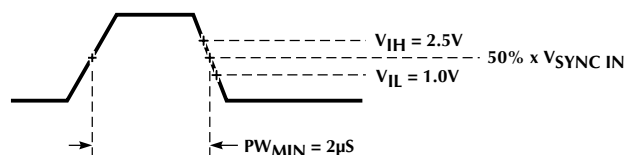

Figure 2. SYNC IN Pulse Width

TYPICAL APPLICATIONS

RECONSTRUCTION FILTER SELECTION FOR HDTV AND VGA SIGNAL FILTERING

The filtering requirements for HDTV and VGA standards vary depending on the resolution of the image to be displayed, and its refresh rate. The actual refresh rate of the display is not necessarily the same as the transmission rate of the frames of images. Some formats use a frame rate of 30Hz, but the display of those formats cannot be scanned onto the CRT at 30Hz. Excessive large area

flicker would result. Such kinds of flicker can be seen on a PAL display with its brightness set high. To avoid this, the video will need to be stored in a frame buffer. This buffer already exists in the MPEG decoder of HDTV systems, so there is no cost penalty. The buffer is read out at twice the rate as the frame rate for 30Hz systems, thus getting us a refresh rate of 60Hz. Similar things are done for the 24Hz frame rate formats to boost them to a 60Hz refresh rate.

PIXELS	VERTICAL LINES	ASPECT RATIO	PICTURE TRANSMISSION RATE
1920	1080	16:9	60I, 30P, 24P
1280	720	16:9	60P, 30P, 24P
704	480	16:9 and 4:3	60P, 60I, 30P,24P
640	480	4:3	60P, 60I, 30P,24P

P=progressive scan, I=interlaced scan

Table 1: HDTV / Advanced TV Applications: (From Table 10.3 from ATSC document A54)

STANDARD	PIXELS	VERTICAL LINES	PICTURE TRANSMISSION RATE (Note 2)	DISPLAY REFRESH RATE (Note 2)	APPROXIMATE HORIZONTAL RATE	APPROXIMATE SAMPLE CLOCK	APPROXIMATE RECONSTRUCTION FILTER CUTOFF	MICRO LINEAR FILTER TO USE (Note 3)
SMPTE 274M	1920	1080	60I	60Hz	35.3KHz	81MHz	40.5MHz	ML6426-6
	1920	1080	30P, 24P	60Hz	70.6KHz	162MHz	81MHz	N/A
SMPTE	1280	720	60P, 30P, 24P	60Hz	47.1KHz	60MHz	30MHz	ML6426-5 ML6426-4
	704	480 (Note 1)	60I	60Hz	15.7KHz	13.5MHz	6.75MHz	ML6426-1
	704	480	60P, 30P, 24P	60Hz	31KHz	27MHz	13.5MHz	ML6426-2 ML6426-4
	640	480 (Note 1)	60I	60Hz	15.7KHz	24.5MHz	12MHz	ML6426-2
	640	480	60P, 30P, 24P	60Hz	31KHz	12.27MHz	6MHz	ML6426-1

P=progressive scan, I=interlaced scan, na = not available

Note 1: NTSC display rates, can be fed directly into NTSC encoder (set top box)

Note 2: 60 Hz also includes 59.94Hz

Note 3: custom frequencies ranging ± 3 to 6MHz can be special cut to order

Table 2: Choosing the Correct Reconstruction Filter and Video Amplifier for TV Applications, ML6426 options

ML6426

TYPICAL APPLICATIONS (Continued)

Pixel clock rates for the output D/A converters can be roughly determined from the Table 1. Don't forget that the deflection system of a CRT display needs retrace time for the vertical and horizontal.

This retrace time can vary from one design of an HDTV set to another, as it only involves tradeoffs between the frame buffer in the MPEG decoder and the CRT deflection system. Allowing for 10% retrace time for the vertical and 20% for the horizontal, the appropriate Reconstruction Filter is summarized in Table 2.

For VGA or RGB monitors, the following resolutions can use the corresponding Reconstruction Filter and Video Amplifier as shown in Table 3.

Figures 4, 5, and 6 show system diagrams when the ML6426 provides a good solution. Figure 7 provides a more detailed description for advanced TV applications using various resolutions for legacy video, SDTV, and HDTV.

USING THE ML6426 IN MULTIPLE RESOLUTIONS

Several ML6426 devices can be used in parallel to construct a selectable filter selection block ranging from frequencies between 6.7 MHz to 50MHz. Each ML6426 can be individually controlled via the disable pin. In a parallel configuration, as shown in Figure 3 and 7, several ML6426 devices can be used and selected via general purpose I/O or other logic to perform the proper reconstruction filtering for the resolution of choice. This configuration allows for a minimum of bill of materials and reduces cost. Micro Linears ML6426 EVAL Kit demonstrates multi-resolution designs. Furthermore, since the ML6426 pin-out is identical for all the options, the filters can be interchanged. This allows for ease of product migration to integrate newer resolutions to filter and drive various DAC outputs at different sampling frequencies.

PIXELS	VERTICAL LINES	NAME	REFRESH RATE (prog except noted)	HORIZONTAL RATE	SAMPLE CLOCK	RECONSTRUCTION FILTER CUTOFF	MICRO LINEAR FILTER TO USE
640	480	VGA	60Hz	31.5kHz	25.175MHz	12.5MHz	ML6426-2
		VGA	72Hz	37.9kHz	31.5MHz	15.5MHz	ML6426-3
		VGA	75Hz	37.5kHz	31.5MHz	15.5MHz	ML6426-3
800	600	SVGA	56Hz	35.1kHz	36MHz	18MHz	ML6426-3
		SVGA	60Hz	37.9kHz	40MHz	20MHz	ML6426-3
		SVGA	72Hz	48.1kHz	50MHz	25MHz	ML6426-3
		SVGA	75Hz	46.9kHz	49.5MHz	25MHz	ML6426-3
1024	768	XGA	43Hz Interlaced	35.5kHz	44.9MHz	23MHz	ML6426-3
		XGA	60Hz	37.9kHz	65MHz	33MHz	ML6426-5
		XGA	70Hz	56.5kHz	75MHz	37.5MHz	ML6426-5
		XGA	75Hz	60kHz	78.75MHz	39.4MHz	ML6426-6
1280	1024	SXGA	75Hz	80kHz	135MHz	68MHz	na
		SXGA	60Hz		113MHz	57MHz	na
1600	1200	UXGA	60Hz		166MHz	83MHz	na

N/A = not available

Table 3: Choosing the Correct Reconstruction Filter and Video Amplifier for TV Applications, ML6426 options

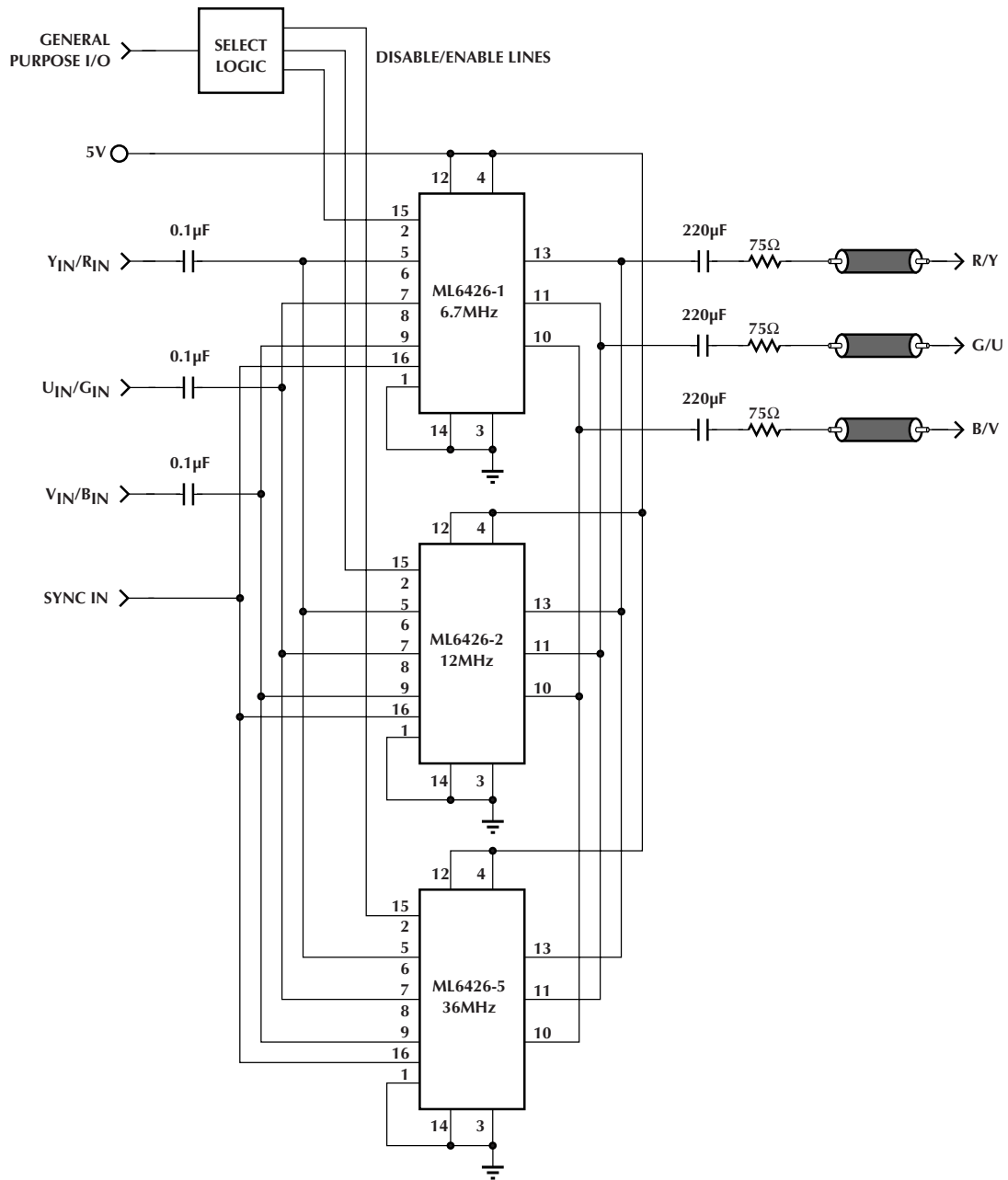

Figure 3. ATSC Digital Television Application

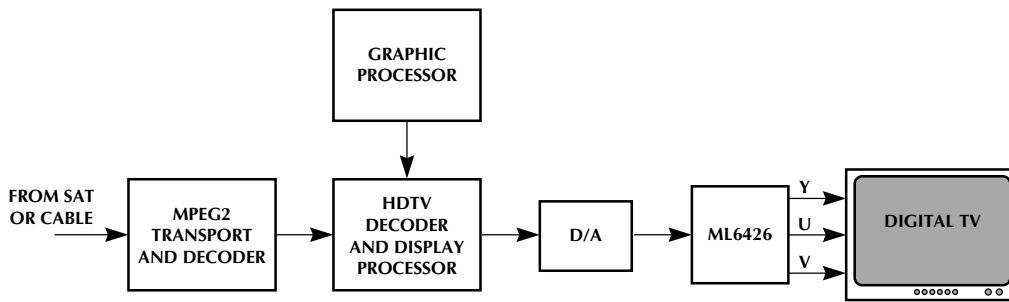

Figure 4. Digital TV Receiver or HDTV Decoder Box

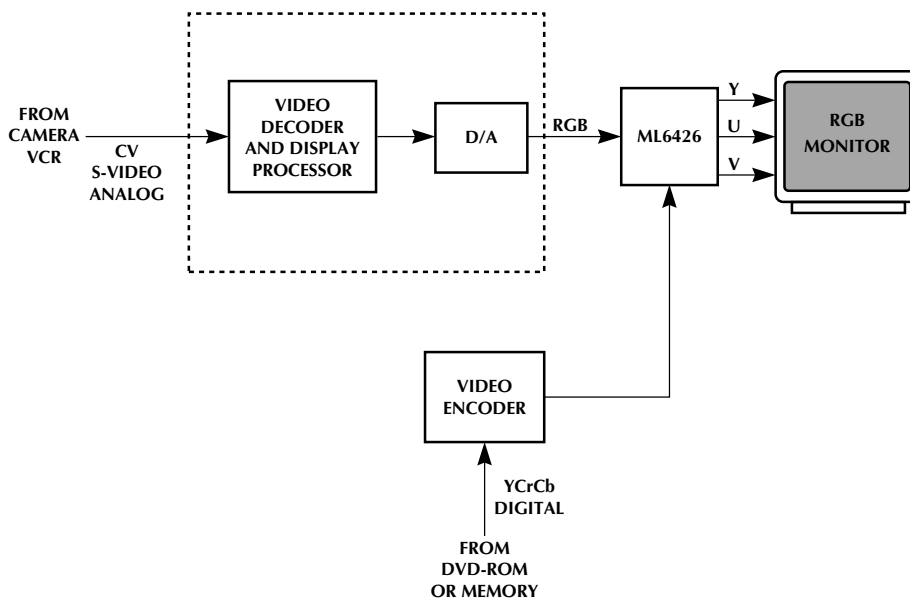

Figure 5. PC Graphics/Frame Grabber Editing Card

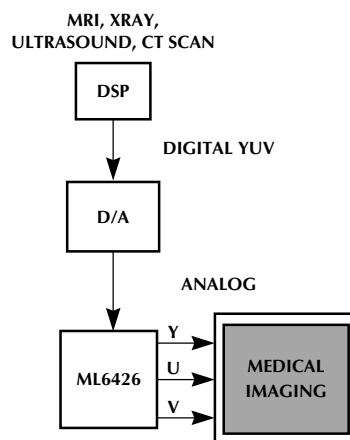

Figure 6. PC MRI, XRAY, Ultrasound, CT Scan

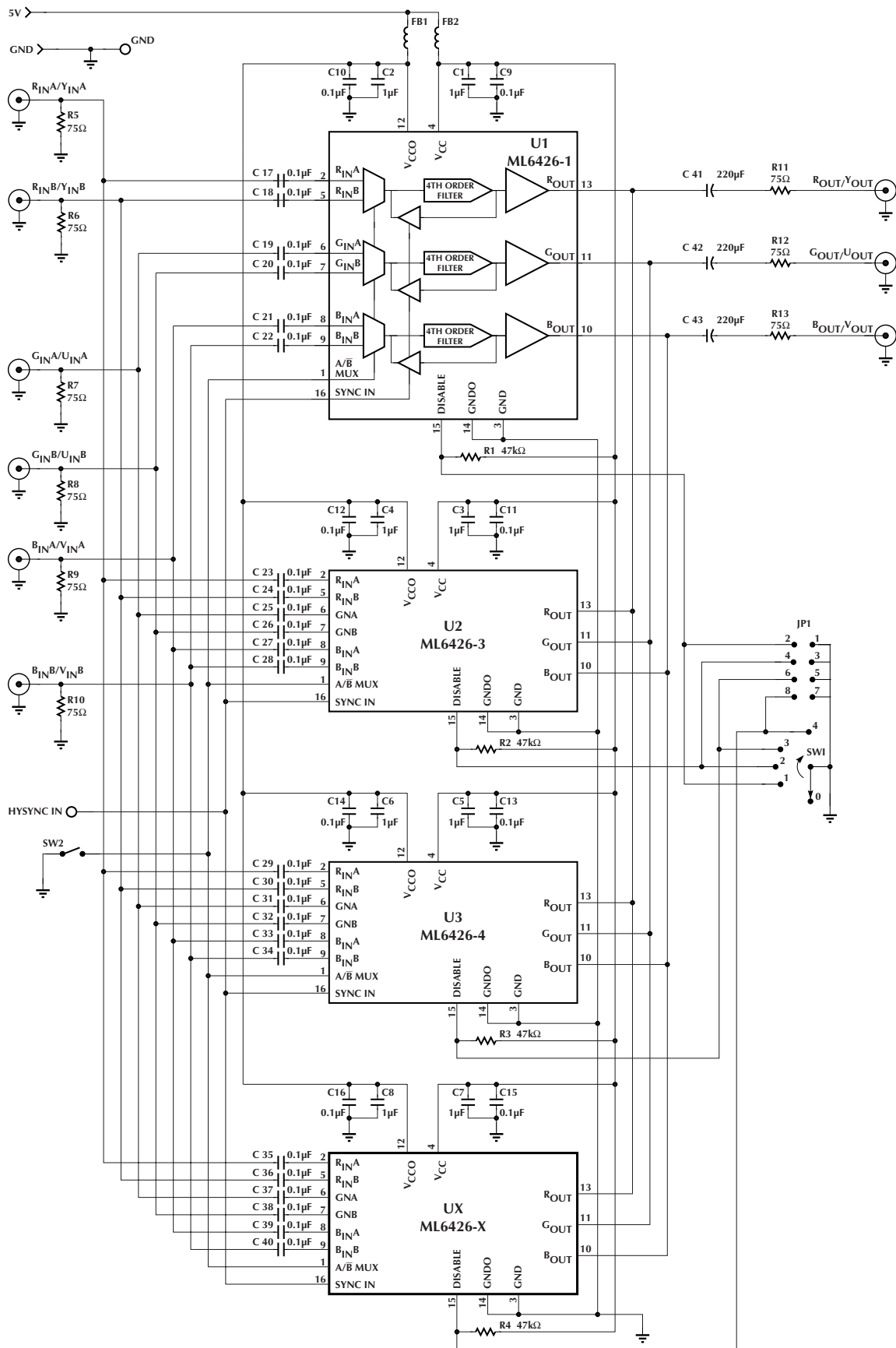

Figure 7. Typical Applications Schematic

ML6426

PERFORMANCE DATA

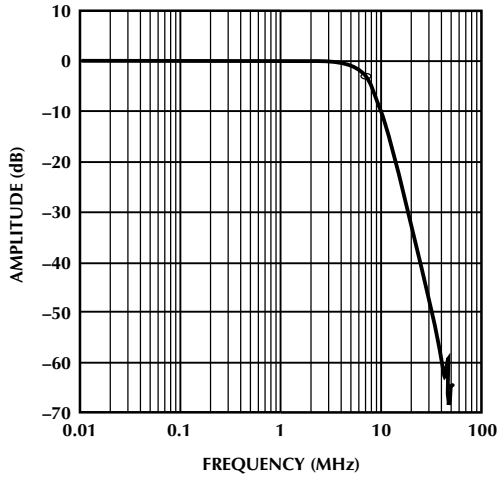

Figure 8. Passband Flatness all Outputs (Normalized) 6.7 MHz, ML6426CS-1

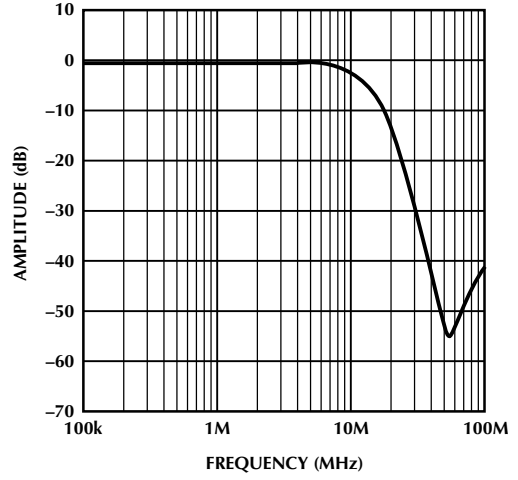

Figure 9. Passband Flatness all Outputs (Normalized) 12MHz, ML6426CS-2

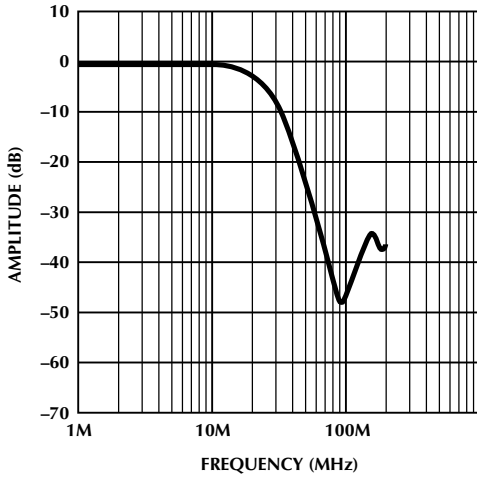

Figure 10. Passband Flatness all Outputs (Normalized) 24 MHz, ML6426CS-3

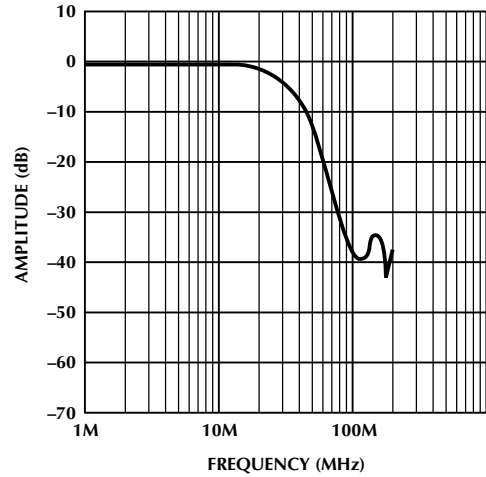

Figure 11. Passband Flatness all Outputs (Normalized) 30 MHz, ML6426CS-4

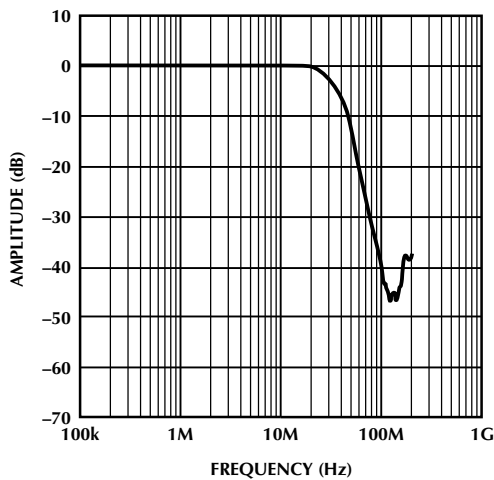

Figure 12. Passband Flatness all Outputs (Normalized) 36MHz, ML6426CS-5

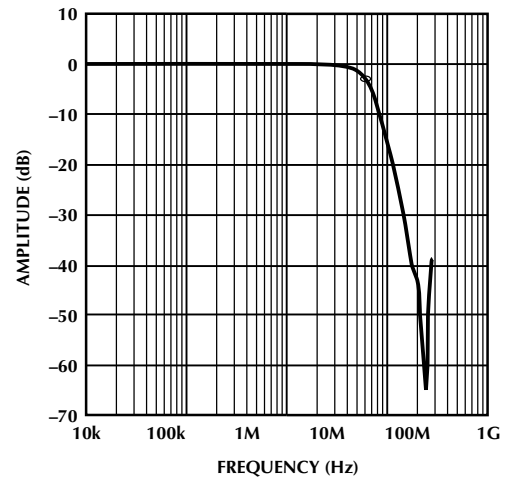

Figure 13. Passband Flatness all Outputs (Normalized) 48MHz, ML6426CS-6

PERFORMANCE DATA (Continued)

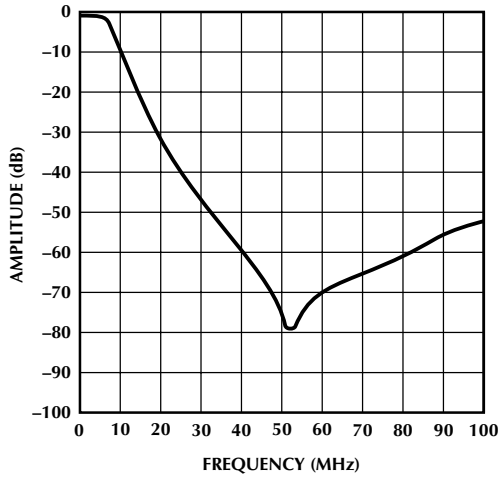

Figure 14. Frequency Response All Outputs ML6426-CS-1

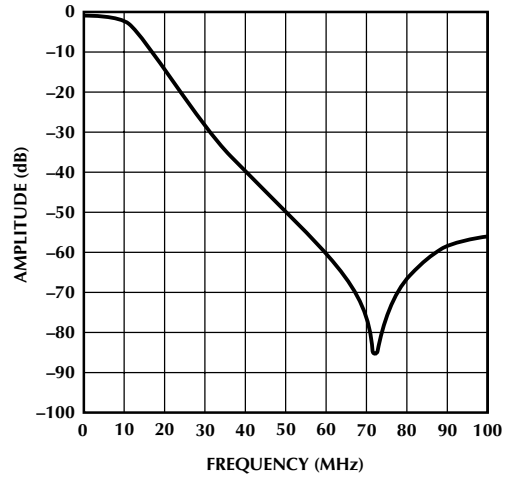

Figure 17. Frequency Response All Outputs ML6426CS-2

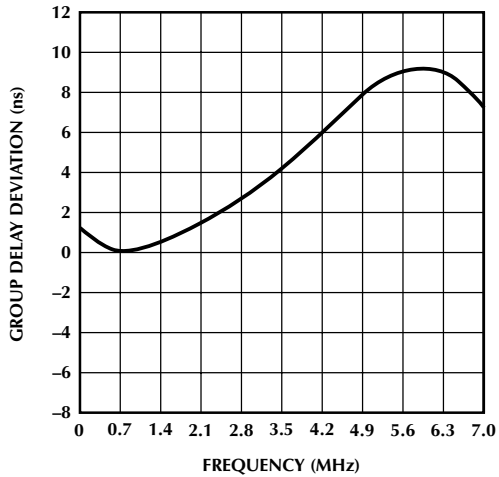

Figure 15. Group Delay Deviation of Passband, All Outputs ML6426CS-1

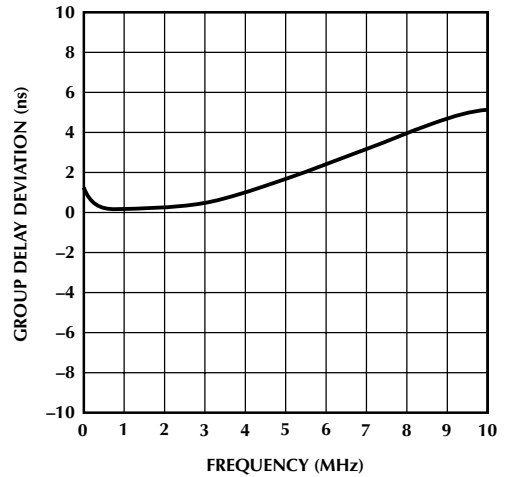

Figure 18. Group Delay Deviation of Passband, All Outputs ML6426CS-2

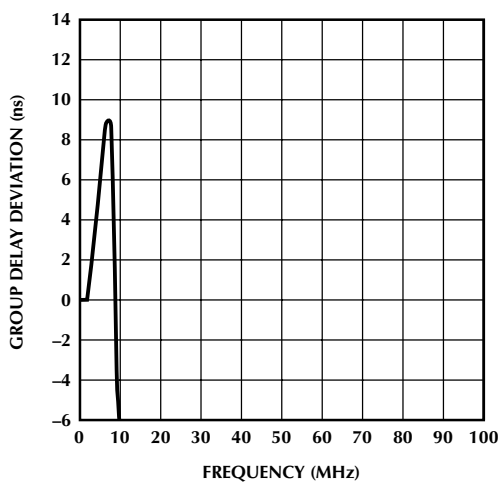

Figure 16. Group Delay Deviation All band, All Outputs ML6426CS-1

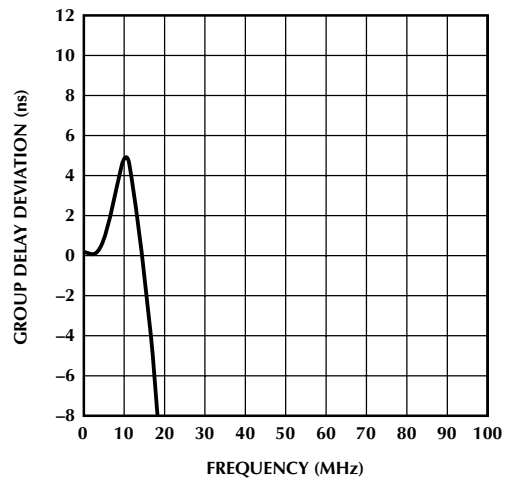

Figure 19. Group Delay Deviation All Band, All Outputs ML6426CS-2

ML6426

PERFORMANCE DATA (Continued)

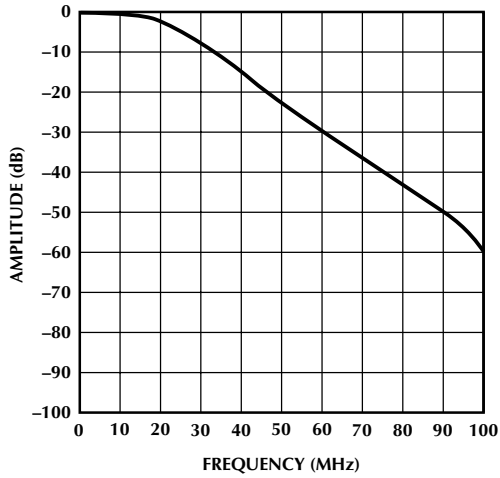

Figure 20. Frequency Response All Outputs ML6426CS-3

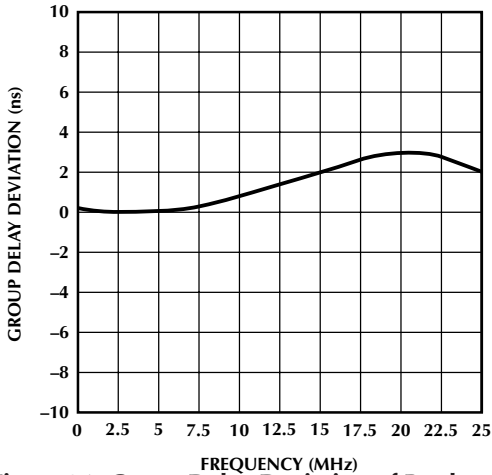

Figure 21. Group Delay Deviation of Passband, All Outputs ML6426CS-3

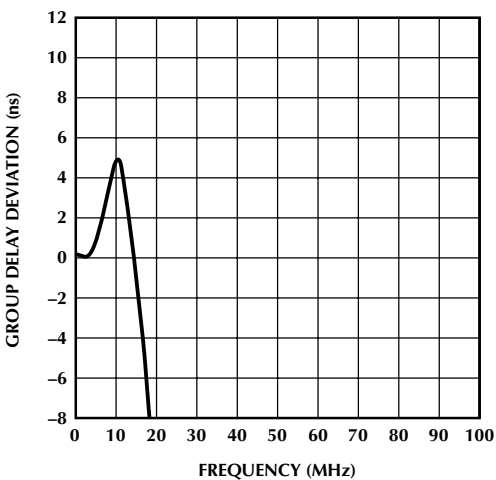

Figure 22. Group Delay Deviation All Band, All Outputs ML6426CS-3

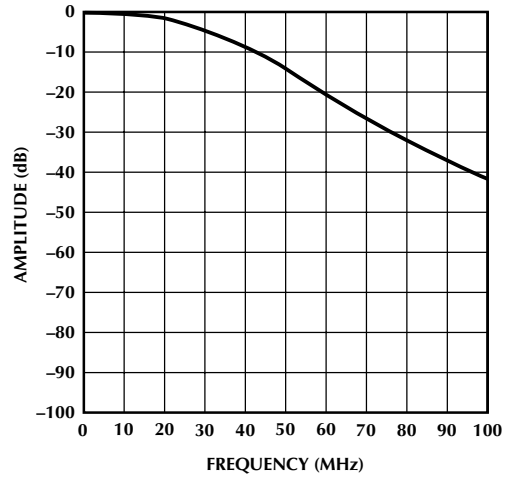

Figure 23. Frequency Response All Outputs ML6426CS-4

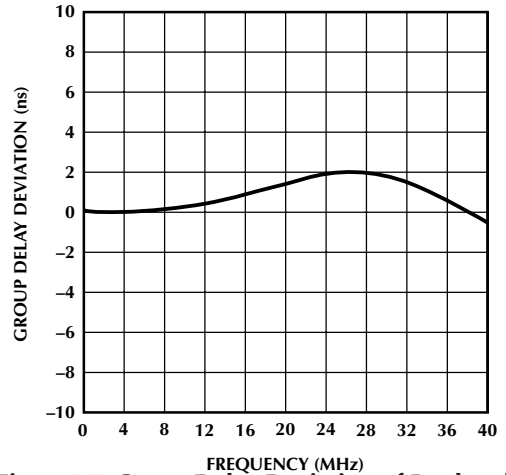

Figure 24. Group Delay Deviation of Passband, All Outputs ML6426CS-4

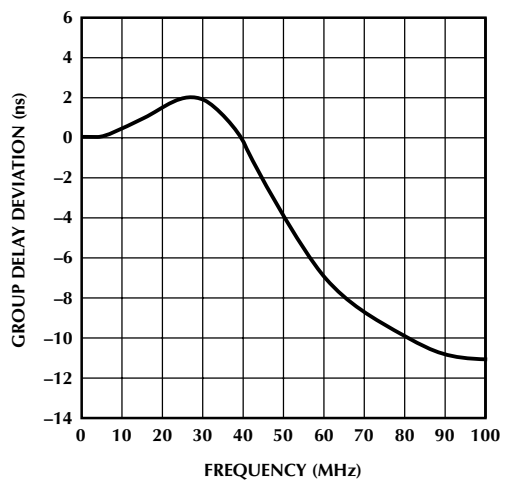

Figure 25. Group Delay Deviation All Band, All Outputs ML6426CS-4

PERFORMANCE DATA (Continued)

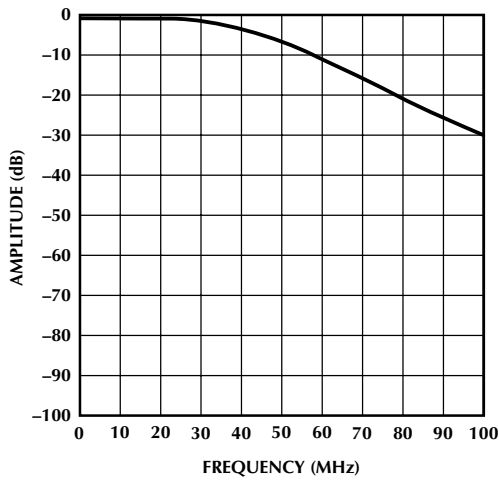

Figure 26. Frequency Response All Outputs ML6426-CS-5

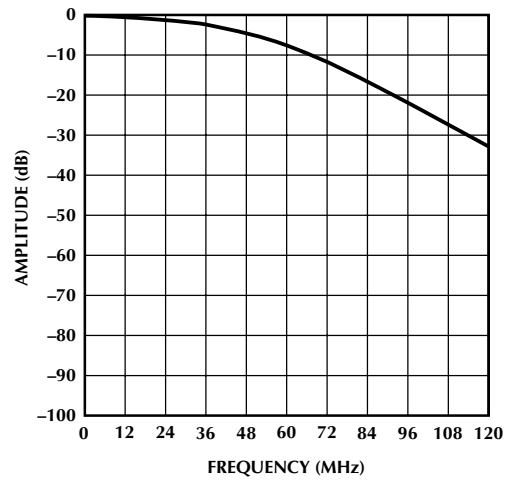

Figure 29. Frequency Response All Outputs ML6426CS-6

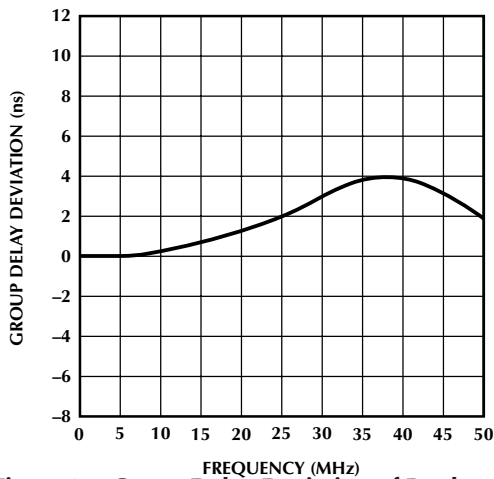

Figure 27. Group Delay Deviation of Passband, All Outputs ML6426CS-5

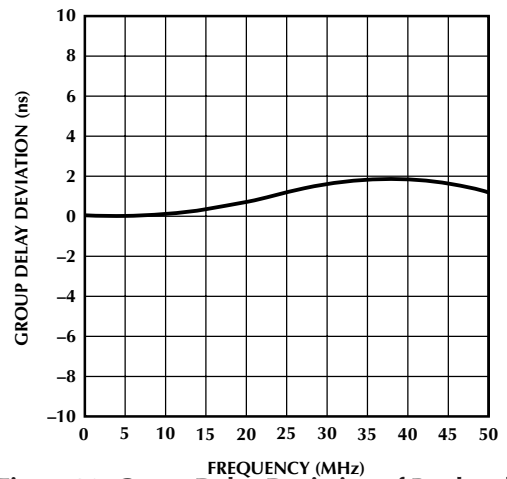

Figure 30. Group Delay Deviation of Passband, All Outputs ML6426CS-6

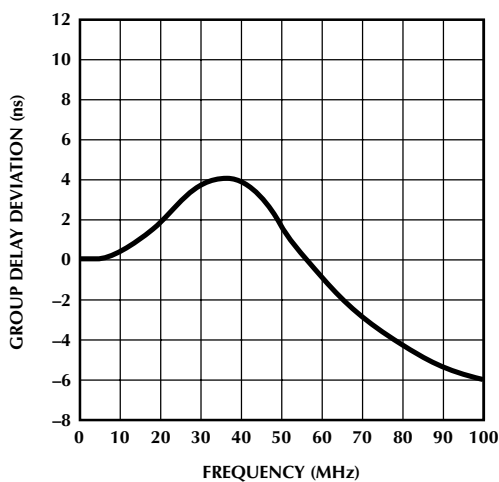

Figure 28. Group Delay Deviation All band, All Outputs ML6426CS-5

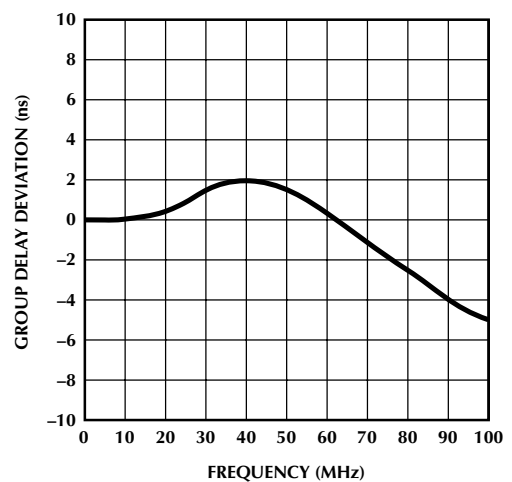
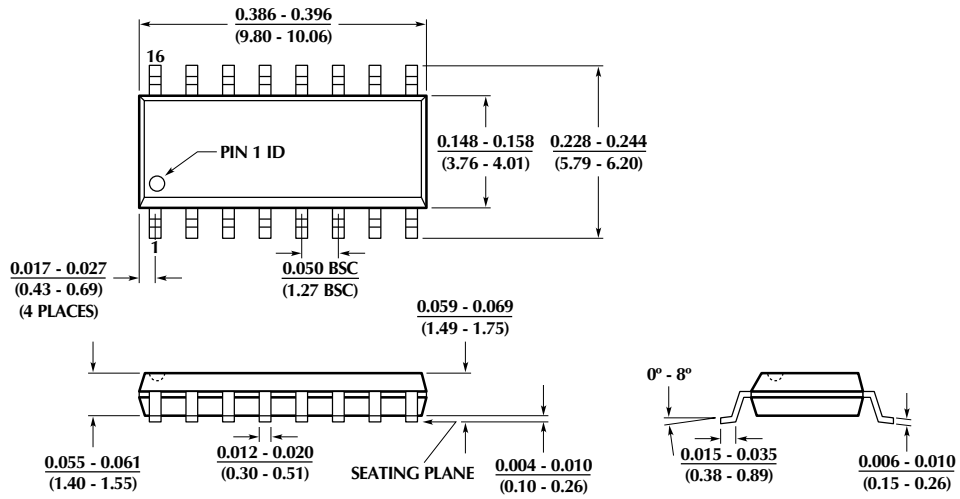

Figure 31. Group Delay Deviation All Band, All Outputs ML6426CS-6

ML6426

PHYSICAL DIMENSIONS

Package: S16N
16-Pin Narrow SOIC



ORDERING INFORMATION

PART NUMBER	CUT-OFF FREQUENCY	TEMPERATURE RANGE	PACKAGE
ML6426CS-1	6.7MHz	0°C to 70°C	16-Pin Narrow SOIC (S16N)
ML6426CS-2	12MHz	0°C to 70°C	16-Pin Narrow SOIC (S16N)
ML6426CS-3	24MHz	0°C to 70°C	16-Pin Narrow SOIC (S16N)
ML6426CS-4	30MHz	0°C to 70°C	16-Pin Narrow SOIC (S16N)
ML6426CS-5	36MHz	0°C to 70°C	16-Pin Narrow SOIC (S16N)
ML6426CS-6	48MHz	0°C to 70°C	16-Pin Narrow SOIC (S16N)
ML6426CS-15	15MHz	0°C to 70°C	16-Pin Narrow SOIC (S16N)

DISCLAIMER

FAIRCHILD SEMICONDUCTOR RESERVES THE RIGHT TO MAKE CHANGES WITHOUT FURTHER NOTICE TO ANY PRODUCTS HEREIN TO IMPROVE RELIABILITY, FUNCTION OR DESIGN. FAIRCHILD DOES NOT ASSUME ANY LIABILITY ARISING OUT OF THE APPLICATION OR USE OF ANY PRODUCT OR CIRCUIT DESCRIBED HEREIN; NEITHER DOES IT CONVEY ANY LICENSE UNDER ITS PATENT RIGHTS, NOR THE RIGHTS OF OTHERS.

LIFE SUPPORT POLICY

FAIRCHILD'S PRODUCTS ARE NOT AUTHORIZED FOR USE AS CRITICAL COMPONENTS IN LIFE SUPPORT DEVICES OR SYSTEMS WITHOUT THE EXPRESS WRITTEN APPROVAL OF THE PRESIDENT OF FAIRCHILD SEMICONDUCTOR CORPORATION. As used herein:

1. Life support devices or systems are devices or systems which, (a) are intended for surgical implant into the body, or (b) support or sustain life, and (c) whose failure to perform when properly used in accordance with instructions for use provided in the labeling, can be reasonably expected to result in a significant injury of the user.
2. A critical component in any component of a life support device or system whose failure to perform can be reasonably expected to cause the failure of the life support device or system, or to affect its safety or effectiveness.