

# NC7WZ126

## TinyLogic® UHS Dual Buffer with 3-STATE Outputs

### General Description

The NC7WZ126 is a Dual Non-Inverting Buffer with independent active HIGH enables for the 3-STATE outputs. The Ultra High Speed device is fabricated with advanced CMOS technology to achieve superior switching performance with high output drive while maintaining low static power dissipation over a broad  $V_{CC}$  operating range. The device is specified to operate over the 1.65V to 5.5V  $V_{CC}$  operating range. The inputs and outputs are high impedance when  $V_{CC}$  is 0V. Inputs tolerate voltages up to 5.5V independent of  $V_{CC}$  operating range. Outputs tolerate voltages above  $V_{CC}$  when in the 3-STATE condition.

### Features

- Space saving US8 surface mount package
- MicroPak™ leadless package
- Ultra High Speed;  $t_{PD}$  2.6 ns Typ into 50 pF at 5V  $V_{CC}$
- High Output Drive;  $\pm 24$  mA at 3V  $V_{CC}$
- Broad  $V_{CC}$  Operating Range: 1.65V to 5.5V
- Matches the performance of LCX when operated at 3.3V  $V_{CC}$
- Power down high impedance inputs/outputs
- Overvoltage tolerant inputs facilitate 5V to 3V translation
- Outputs are overvoltage tolerant in 3-STATE mode
- Patented noise/EMI reduction circuitry implemented

### Ordering Code:

Order Number	Package Number	Product Code Top Mark	Package Description	Supplied As
NC7WZ126K8X	MAB08A	WZ26	8-Lead US8, JEDEC MO-187, Variation CA 3.1mm Wide	3k Units on Tape and Reel
NC7WZ126L8X	MAC08A	T6	8-Lead MicroPak, 1.6 mm Wide	5k Units on Tape and Reel

### Logic Symbol

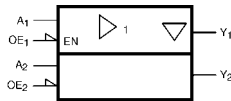

### Pin Descriptions

Pin Names	Description
$OE_n$	Enable Inputs for 3-STATE Outputs
$A_n$	Inputs
$Y_n$	3-STATE Outputs

### Function Table

Inputs		Output
OE	$A_n$	$Y_n$
H	L	L
H	H	H
L	L	Z
L	H	Z

H = HIGH Logic Level    L = LOW Logic Level    Z = 3-STATE

TinyLogic® is a registered trademark of Fairchild Semiconductor Corporation.  
MicroPak™ is a trademark of Fairchild Semiconductor Corporation.

### Connection Diagrams

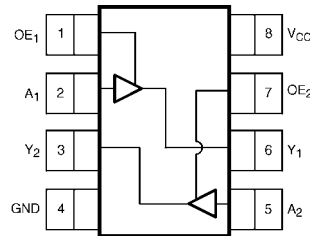

(Top View)

### Pad Assignments for MicroPak

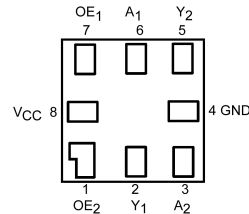

(Top Thru View)

### Absolute Maximum Ratings (Note 1)

Supply Voltage ( $V_{CC}$ )	-0.5V to +7.0V
DC Input Voltage ( $V_{IN}$ ) (Note 2)	-0.5V to +7.0V
DC Output Voltage ( $V_{OUT}$ )	-0.5V to +7.0V
DC Input Diode Current ( $I_{IK}$ ) @ $V_{IN} < 0V$	-50 mA
DC Output Diode Current ( $I_{OK}$ ) @ $V_{OUT} < 0V$	-50 mA
DC Output Source/Sink Current ( $I_{OUT}$ )	$\pm 50$ mA
DC $V_{CC}/GND$ Current ( $I_{CC}/I_{GND}$ )	$\pm 100$ mA
Storage Temperature Range ( $T_{STG}$ )	-65°C to +150°C
Junction Temperature under Bias ( $T_J$ )	+150°C
Junction Lead Temperature ( $T_L$ ) (Soldering, 10 seconds)	+260°C
Power Dissipation ( $P_D$ ) @ +85°C	250 mW

### Recommended Operating Conditions (Note 3)

Supply Voltage Operating ( $V_{CC}$ )	1.65V to 5.5V
Supply Voltage Data Retention ( $V_{CC}$ )	1.5V to 5.5V
Input Voltage ( $V_{IN}$ )	0V to 5.5V
Output Voltage ( $V_{OUT}$ )	
Active State	0V to $V_{CC}$
3-State	0V to 5.5V
Operating Temperature ( $T_A$ )	-40°C to +85°C
Input Rise and Fall Time ( $t_r, t_f$ )	
$V_{CC} = 1.8V, 0.15V, 2.5V \pm 0.2V$	0 ns/V to 20 ns/V
$V_{CC} = 3.8V \pm 0.3V$	0 ns/V to 10 ns/V
$V_{CC} = 5.0V \pm 0.5V$	0 ns/V to 5 ns/V
Thermal Resistance ( $\theta_{JA}$ )	250°C/W

**Note 1:** Absolute maximum ratings are DC values beyond which the device may be damaged or have its useful life impaired. The datasheet specifications should be met, without exception, to ensure that the system design is reliable over its power supply, temperature, and output/input loading variables. Fairchild does not recommend operation outside datasheet specifications.

**Note 2:** The input and output negative voltage ratings may be exceeded if the input and output diode current ratings are observed.

**Note 3:** Unused inputs must be held HIGH or LOW. They may not float.

### DC Electrical Characteristics

Symbol	Parameter	$V_{CC}$ (V)	$T_A = +25^\circ\text{C}$			$T_A = -40^\circ\text{C to } +85^\circ\text{C}$		Unit	Conditions	
			Min	Typ	Max	Min	Max			
$V_{IH}$	HIGH Level Input Voltage	1.65 to 1.95 2.3 to 5.5	0.75 $V_{CC}$ 0.7 $V_{CC}$			0.75 $V_{CC}$ 0.7 $V_{CC}$		V		
$V_{IL}$	LOW Level Input Voltage	1.65 to 1.95 2.3 to 5.5	0.25 $V_{CC}$ 0.3 $V_{CC}$			0.25 $V_{CC}$ 0.3 $V_{CC}$		V		
$V_{OH}$	HIGH Level Output Voltage	1.65 2.3 3.0 4.5	1.55 2.2 2.9 4.4	1.65 2.3 3.0 4.5	1.55 2.2 2.9 4.4		V	$V_{IN} = V_{IH}$ or $V_{IL}$	$I_{OH} = -100 \mu\text{A}$	
		1.65 2.3 3.0 4.5	1.29 1.9 2.4 3.8	1.52 2.15 2.80 4.20	1.29 1.9 2.4 3.8		V	$V_{IN} = V_{IH}$ or $V_{IL}$	$I_{OH} = -4 \text{ mA}$ $I_{OH} = -8 \text{ mA}$ $I_{OH} = -16 \text{ mA}$ $I_{OH} = -24 \text{ mA}$ $I_{OH} = -32 \text{ mA}$	
$V_{OL}$	LOW Level Output Voltage	1.65 2.3 3.0 4.5	0.0 0.0 0.0 0.0			0.10 0.10 0.10 0.10		V	$V_{IN} = V_{IH}$ or $V_{IL}$	$I_{OL} = 100 \mu\text{A}$
		1.65 2.3 3.0 4.5	0.08 0.10 0.15 0.22	0.24 0.3 0.4 0.55	0.24 0.3 0.4 0.55		V	$V_{IN} = V_{IH}$ or $V_{IL}$	$I_{OL} = 4 \text{ mA}$ $I_{OL} = 8 \text{ mA}$ $I_{OL} = 16 \text{ mA}$ $I_{OL} = 24 \text{ mA}$ $I_{OL} = 32 \text{ mA}$	
$I_{IN}$	Input Leakage Current	0 to 5.5	$\pm 0.1$			$\pm 1$		$\mu\text{A}$	$V_{IN} = 5.5V, GND$	
$I_{OZ}$	3-STATE Output Leakage	1.65 to 5.5	$\pm 0.5$			$\pm 5$		$\mu\text{A}$	$V_{IN} = V_{IH}$ or $V_{IL}$ $0 \leq V_{OUT} \leq 5.5V$	
$I_{OFF}$	Power Off Leakage Current	0.0	1			10		$\mu\text{A}$	$V_{IN}$ or $V_{OUT} = 5.5V$	
$I_{CC}$	Quiescent Supply Current	1.65 to 5.5	1			10		$\mu\text{A}$	$V_{IN} = 5.5V, GND$	

Noise Characteristics										
Symbol	Parameter	V <sub>CC</sub> (V)	T <sub>A</sub> = +25°C		Units	Conditions				
			Typ	Max						
V <sub>OLP</sub> (Note 4)	Quiet Output Maximum Dynamic V <sub>OL</sub>	5.0		1.0	V	C <sub>L</sub> = 50 pF				
V <sub>OLV</sub> (Note 4)	Quiet Output Minimum Dynamic V <sub>OL</sub>	5.0		1.0	V	C <sub>L</sub> = 50 pF				
V <sub>OHV</sub> (Note 4)	Quiet Output Minimum Dynamic V <sub>OH</sub>	5.0		4.0	V	C <sub>L</sub> = 50 pF				
V <sub>IHD</sub> (Note 4)	Minimum HIGH Level Dynamic Input Voltage	5.0		3.5	V	C <sub>L</sub> = 50 pF				
V <sub>ILD</sub> (Note 4)	Maximum LOW Level Dynamic Input Voltage	5.0		1.5	V	C <sub>L</sub> = 50 pF				
<b>Note 4:</b> Parameter guaranteed by design.										
AC Electrical Characteristics										
Symbol	Parameter	V <sub>CC</sub> (V)	T <sub>A</sub> = +25°C			T <sub>A</sub> = -40°C to +85°C		Units	Conditions	Figure Number
			Min	Typ	Max	Min	Max			
t <sub>PLH</sub>	Propagation Delay A <sub>n</sub> to Y <sub>n</sub>	1.8 ± 0.15	2.0		12.0	2.0	13.0	ns	C <sub>L</sub> = 15 pF RD = 1 MΩ S <sub>1</sub> = OPEN	Figures 1, 3
t <sub>PHL</sub>		2.5 ± 0.2	1.0		7.5	1.0	8.0			
		3.3 ± 0.3	0.8		5.2	0.8	5.5			
		5.0 ± 0.5	0.5		4.5	0.5	4.8			
t <sub>PLH</sub>	Propagation Delay A <sub>n</sub> to Y <sub>n</sub>	3.3 ± 0.3	1.2		5.7	1.2	6.0	ns	C <sub>L</sub> = 50 pF RD = 500Ω S <sub>1</sub> = OPEN	Figures 1, 3
t <sub>PHL</sub>		5.0 ± 0.5	0.8		5.0	0.8	5.3			
t <sub>OSLH</sub>	Output to Output Skew (Note 5)	3.3 ± 0.3			1.0		1.0	ns	C <sub>L</sub> = 50 pF RD = 500Ω S <sub>1</sub> = OPEN	Figures 1, 3
t <sub>OSHL</sub>		5.0 ± 0.5			0.8		0.8			
t <sub>PZL</sub>	Output Enable Time	1.8 ± 0.15	3.0		14.0	3.0	15.0	ns	C <sub>L</sub> = 50 pF RD, RU = 500Ω S <sub>1</sub> = GND for t <sub>PZH</sub> S <sub>1</sub> = V <sub>I</sub> for t <sub>PZL</sub> V <sub>I</sub> = 2 × V <sub>CC</sub>	Figures 1, 3
t <sub>PZH</sub>		2.5 ± 0.2	1.8		8.5	1.8	9.0			
		3.3 ± 0.3	1.2		6.2	1.2	6.5			
		5.0 ± 0.5	0.8		5.5	0.8	5.8			
t <sub>PLZ</sub>	Output Disable Time	1.8 ± 0.15	2.5		12.0	2.5	13.0	ns	C <sub>L</sub> = 50 pF RD, RU = 500Ω S <sub>1</sub> = GND for t <sub>PHZ</sub> S <sub>1</sub> = V <sub>I</sub> for t <sub>PLZ</sub> V <sub>I</sub> = 2 × V <sub>CC</sub>	Figures 1, 3
t <sub>PHZ</sub>		2.5 ± 0.2	1.5		8.0	1.5	8.5			
		3.3 ± 0.3	0.8		5.7	0.8	6.0			
		5.0 ± 0.5	0.3		4.7	0.3	5.0			
C <sub>IN</sub>	Input Capacitance	0		2.5				pF		
C <sub>OUT</sub>	Output Capacitance	5.0		4						
C <sub>PD</sub>	Power Dissipation Capacitance	3.3		10				pF	(Note 6)	Figure 2
		5.0		12						
<b>Note 5:</b> Parameter guaranteed by design. t <sub>OSLH</sub> =  t <sub>PLHmax</sub> - t <sub>PLHmin</sub>  ; t <sub>OSHL</sub> =  t <sub>PHLmax</sub> - t <sub>PHLmin</sub>  .										
<b>Note 6:</b> C <sub>PD</sub> is defined as the value of the internal equivalent capacitance which is derived from dynamic operating current consumption (I <sub>CCD</sub> ) at no output loading and operating at 50% duty cycle. (See Figure 2.) C <sub>PD</sub> is related to I <sub>CCD</sub> dynamic operating current by the expression: I <sub>CCD</sub> = (CPD) (V <sub>CC</sub> ) (f <sub>N</sub> ) + (I <sub>CC</sub> static).										

## AC Loading and Waveforms

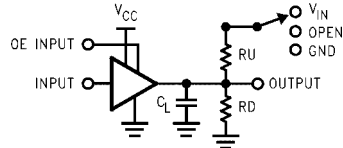

$C_L$  includes load and stray capacitance  
 Input PRR = 1.0 MHz,  $t_w = 500$  ns

**FIGURE 1. AC Test Circuit**

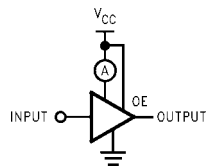

Input = AC Waveform;  $t_r = t_f = 1.8$  ns;  
 PRR = 10 MHz; Duty Cycle = 50%

**FIGURE 2.  $I_{CCD}$  Test Circuit**

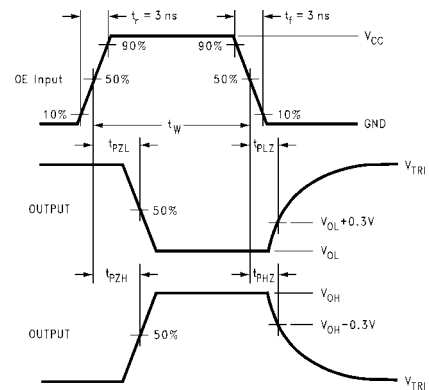
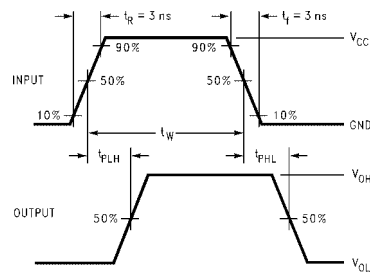

**FIGURE 3. AC Waveforms**

## Tape and Reel Specification

### TAPE FORMAT for US8

Package Designator	Tape Section	Number Cavities	Cavity Status	Cover Tape Status
K8X	Leader (Start End)	125 (typ)	Empty	Sealed
	Carrier	3000	Filled	Sealed
	Trailer (Hub End)	75 (typ)	Empty	Sealed

### TAPE DIMENSIONS inches (millimeters)

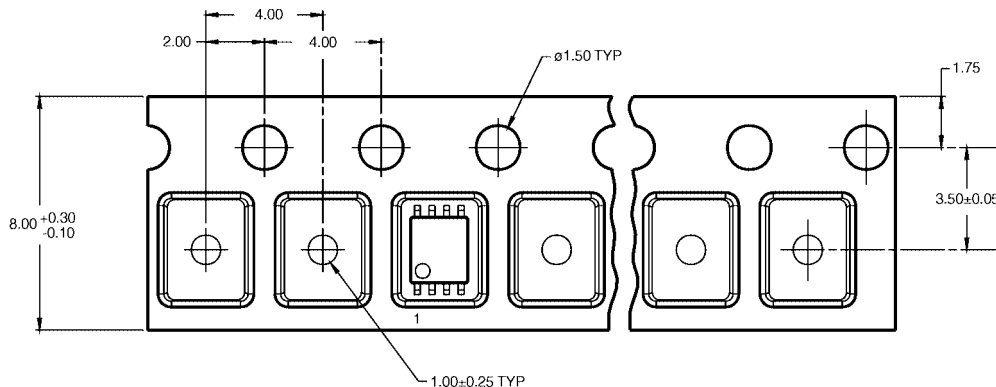

### TAPE FORMAT for MicroPak

Package Designator	Tape Section	Number Cavities	Cavity Status	Cover Tape Status
L8X	Leader (Start End)	125 (typ)	Empty	Sealed
	Carrier	3000	Filled	Sealed
	Trailer (Hub End)	75 (typ)	Empty	Sealed

### TAPE DIMENSIONS inches (millimeters)

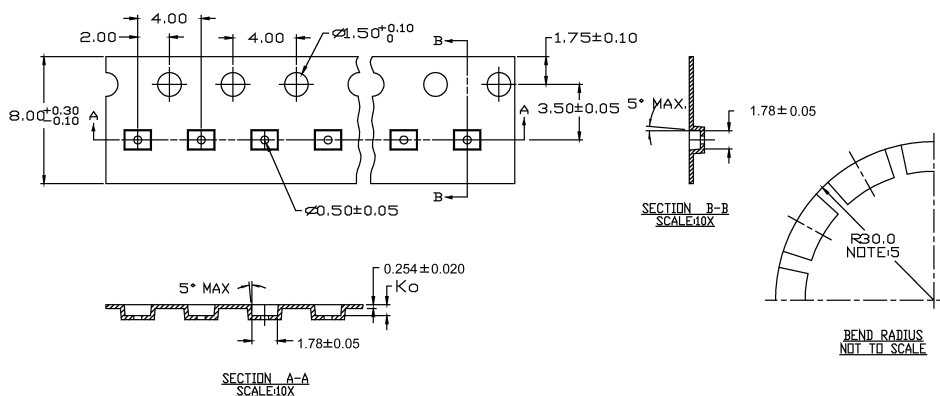

**Tape and Reel Specification** (Continued)

REEL DIMENSIONS inches (millimeters)

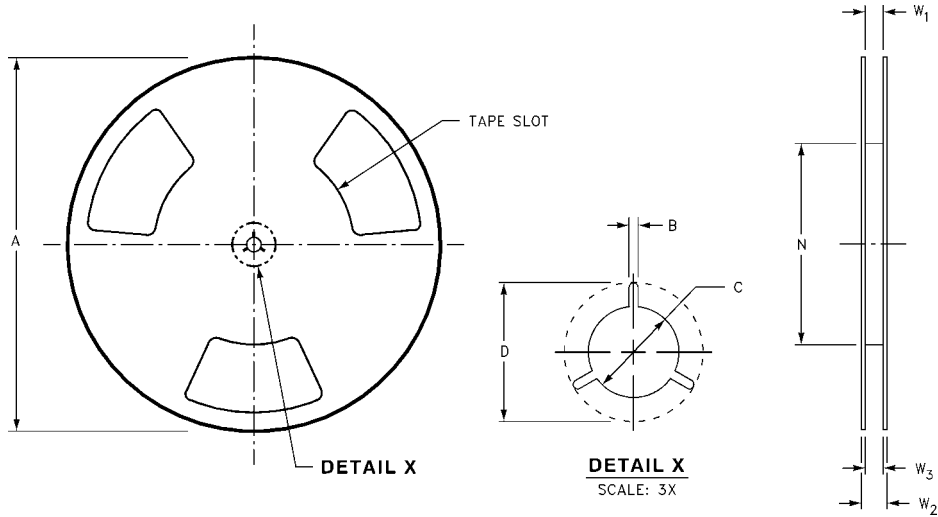

Tape Size	A	B	C	D	N	W1	W2	W3
8 mm	7.0 (177.8)	0.059 (1.50)	0.512 (13.00)	0.795 (20.20)	2.165 (55.00)	0.331 + 0.059/-0.000 (8.40 + 1.50/-0.00)	0.567 (14.40)	W1 + 0.078/-0.039 (W1 + 2.00/-1.00)

**Physical Dimensions** inches (millimeters) unless otherwise noted

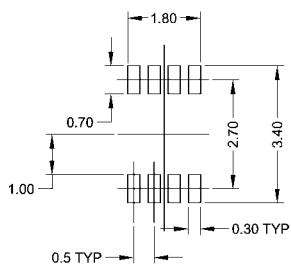
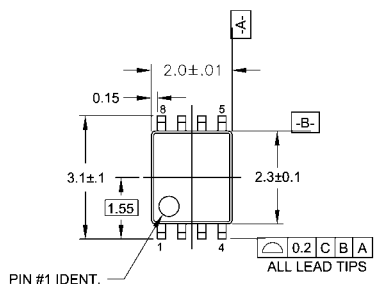

**LAND PATTERN RECOMMENDATION**

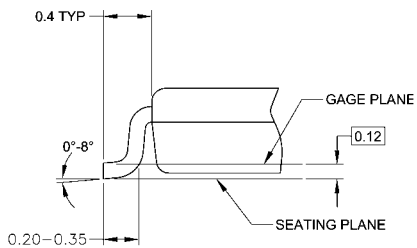
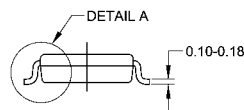
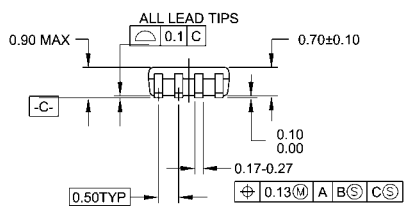

**DETAIL A**

**NOTES:**

- A. CONFORMS TO JEDEC REGISTRATION MO-187
- B. DIMENSIONS ARE IN MILLIMETERS.
- C. DIMENSIONS ARE EXCLUSIVE OF BURRS, MOLD FLASH, AND TIE BAR EXTRUSIONS.
- D. DIMENSIONS AND TOLERANCES PER ANSI Y14.5M, 1982.

MAB08AREVC

**8-Lead US8, JEDEC MO-187, Variation CA 3.1mm Wide  
Package Number MAB08A**

**Physical Dimensions** inches (millimeters) unless otherwise noted (Continued)

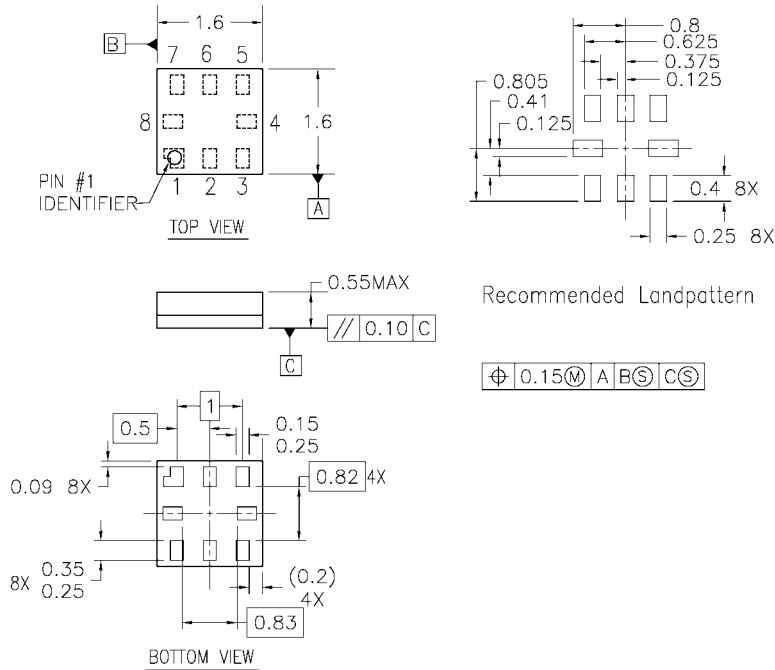

Notes:

1. PACKAGE REGISTRATION WITH JEDEC IS ANTICIPATED
2. DIMENSIONS ARE IN MILLIMETERS
3. DRAWING CONFORMS TO ASME Y.14M-1994

MAC08AREVB

**8-Lead MicroPak, 1.6 mm Wide  
Package Number MAC08A**

Fairchild does not assume any responsibility for use of any circuitry described, no circuit patent licenses are implied and Fairchild reserves the right at any time without notice to change said circuitry and specifications.

**LIFE SUPPORT POLICY**

FAIRCHILD'S PRODUCTS ARE NOT AUTHORIZED FOR USE AS CRITICAL COMPONENTS IN LIFE SUPPORT DEVICES OR SYSTEMS WITHOUT THE EXPRESS WRITTEN APPROVAL OF THE PRESIDENT OF FAIRCHILD SEMICONDUCTOR CORPORATION. As used herein:

1. Life support devices or systems are devices or systems which, (a) are intended for surgical implant into the body, or (b) support or sustain life, and (c) whose failure to perform when properly used in accordance with instructions for use provided in the labeling, can be reasonably expected to result in a significant injury to the user.
2. A critical component in any component of a life support device or system whose failure to perform can be reasonably expected to cause the failure of the life support device or system, or to affect its safety or effectiveness.

[www.fairchildsemi.com](http://www.fairchildsemi.com)