

PACKAGE DIMENSIONS

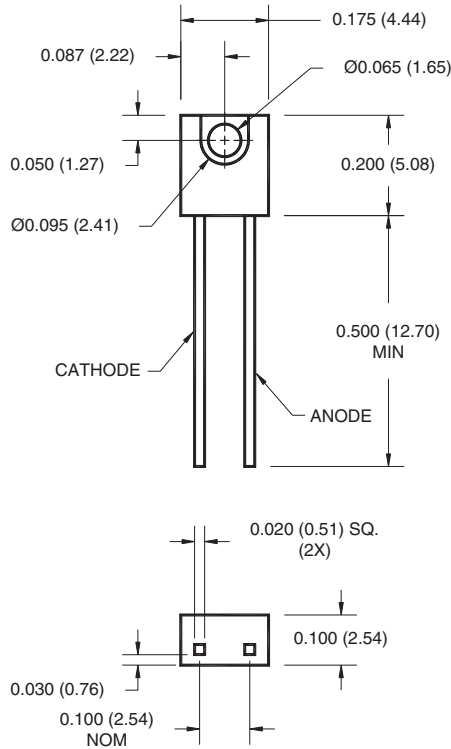

NOTES:

1. Dimensions for all drawings are in inches (mm).
2. Tolerance of $\pm .010$ (.25) on all non-nominal dimensions unless otherwise specified.

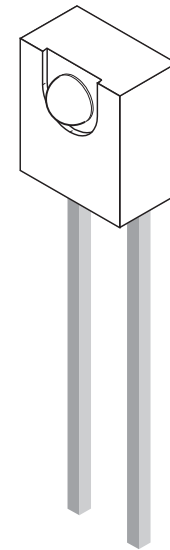

SCHEMATIC

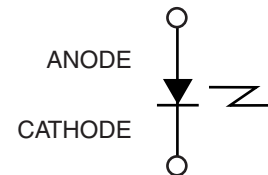

DESCRIPTION

The QEE12X is a 880 nm AlGaAs LED encapsulated in a medium wide angle, plastic sidelooker package.

FEATURES

- $\lambda = 880$ nm
- Package Type = Sidelooker
- Chip Material = AlGaAs
- Matched Photosensor: QSE113
- Medium Wide Emission Angle, 50°
- Package Material: Clear Epoxy
- High Output Power
- Orange stripe on the top side

ABSOLUTE MAXIMUM RATINGS ($T_A = 25^\circ\text{C}$ unless otherwise specified)

Parameter	Symbol	Rating	Unit
Operating Temperature	T_{OPR}	-40 to + 100	$^\circ\text{C}$
Storage Temperature	T_{STG}	-40 to + 100	$^\circ\text{C}$
Soldering Temperature (Iron) ^(2,3,4)	$T_{\text{SOL-I}}$	240 for 5 sec	$^\circ\text{C}$
Soldering Temperature (Flow) ^(2,3)	$T_{\text{SOL-F}}$	260 for 10 sec	$^\circ\text{C}$
Continuous Forward Current	I_F	50	mA
Reverse Voltage	V_R	5	V
Power Dissipation ⁽¹⁾	P_D	100	mW

NOTES:

1. Derate power dissipation linearly 1.33 mW/ $^\circ\text{C}$ above 25 $^\circ\text{C}$.
2. RMA flux is recommended.
3. Methanol or isopropyl alcohols are recommended as cleaning agents.
4. Soldering iron 1/16" (1.6 mm) minimum from housing

ELECTRICAL / OPTICAL CHARACTERISTICS ($T_A = 25^\circ\text{C}$)

Parameter	Test Conditions	Symbol	Min	Typ	Max	Units
Peak Emission Wavelength	$I_F = 100 \text{ mA}$	λ_{PE}	—	940	—	nm
Emission Angle	$I_F = 100 \text{ mA}$	$2\theta_{1/2}$	—	50	—	Deg.
Forward Voltage	$I_F = 100 \text{ mA}$, $t_p = 20 \text{ ms}$	V_F	—	—	1.7	V
Reverse Current	$V_R = 5 \text{ V}$	I_R	—	—	10	μA
Radiant Intensity QEE122	$I_F = 100 \text{ mA}$, $t_p = 20 \text{ ms}$	I_E	4	—	16	mW/sr
Radiant Intensity QEE123	$I_F = 100 \text{ mA}$, $t_p = 20 \text{ ms}$	I_E	8	—	—	mW/sr
Rise Time	$I_F = 100 \text{ mA}$	t_r	—	800	—	ns
Fall Time		t_f	—	800	—	ns

Fig.1 Normalized Radiant Intensity vs. Forward Current

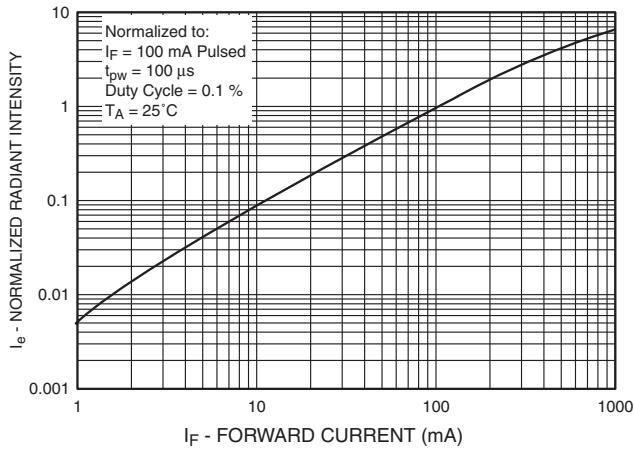

Fig.2 Coupling Characteristics of QEE123 And QSE113

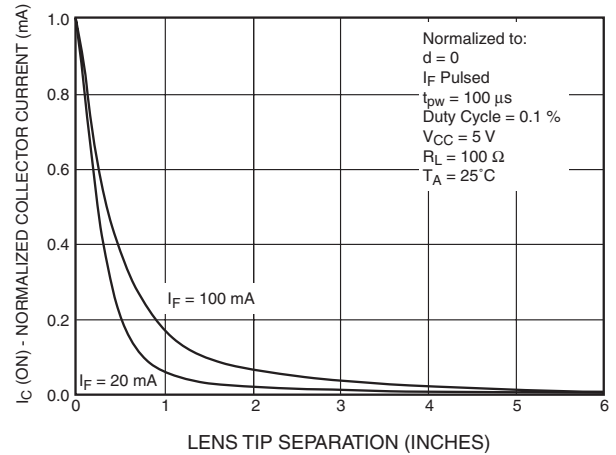

Fig.3 Forward Voltage vs. Ambient Temperature

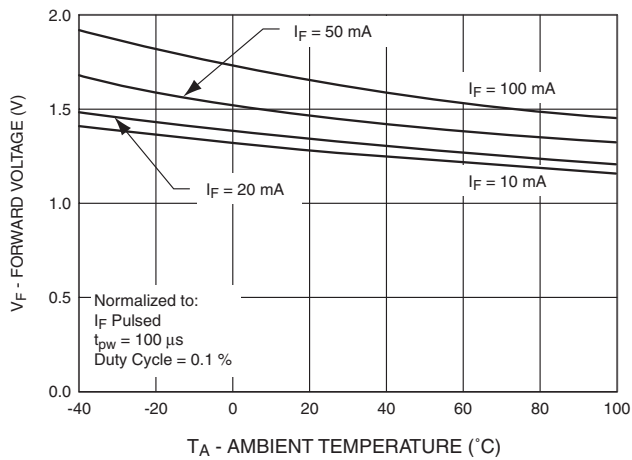

Fig. 4 Normalized Intensity vs. Wavelength

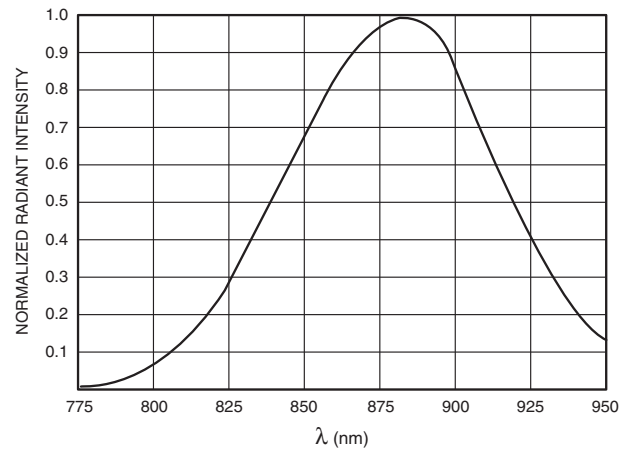
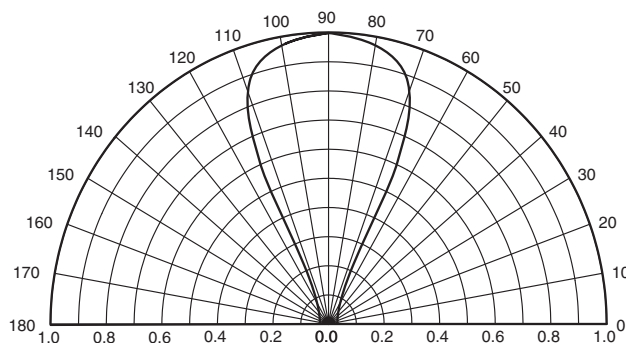

Fig. 5 Radiation Diagram



DISCLAIMER

FAIRCHILD SEMICONDUCTOR RESERVES THE RIGHT TO MAKE CHANGES WITHOUT FURTHER NOTICE TO ANY PRODUCTS HEREIN TO IMPROVE RELIABILITY, FUNCTION OR DESIGN. FAIRCHILD DOES NOT ASSUME ANY LIABILITY ARISING OUT OF THE APPLICATION OR USE OF ANY PRODUCT OR CIRCUIT DESCRIBED HEREIN; NEITHER DOES IT CONVEY ANY LICENSE UNDER ITS PATENT RIGHTS, NOR THE RIGHTS OF OTHERS.

LIFE SUPPORT POLICY

FAIRCHILD'S PRODUCTS ARE NOT AUTHORIZED FOR USE AS CRITICAL COMPONENTS IN LIFE SUPPORT DEVICES OR SYSTEMS WITHOUT THE EXPRESS WRITTEN APPROVAL OF THE PRESIDENT OF FAIRCHILD SEMICONDUCTOR CORPORATION. As used herein:

1. Life support devices or systems are devices or systems which, (a) are intended for surgical implant into the body, or (b) support or sustain life, and (c) whose failure to perform when properly used in accordance with instructions for use provided in the labeling, can be reasonably expected to result in a significant injury of the user.
2. A critical component in any component of a life support device or system whose failure to perform can be reasonably expected to cause the failure of the life support device or system, or to affect its safety or effectiveness.