

GBPC6005 THRU GBPC610

GLASS PASSIVATED SINGLE-PHASE BRIDGE RECTIFIER

Reverse Voltage - 50 to 1000 Volts Forward Current - 6.0 Amperes

Case Style GBPC

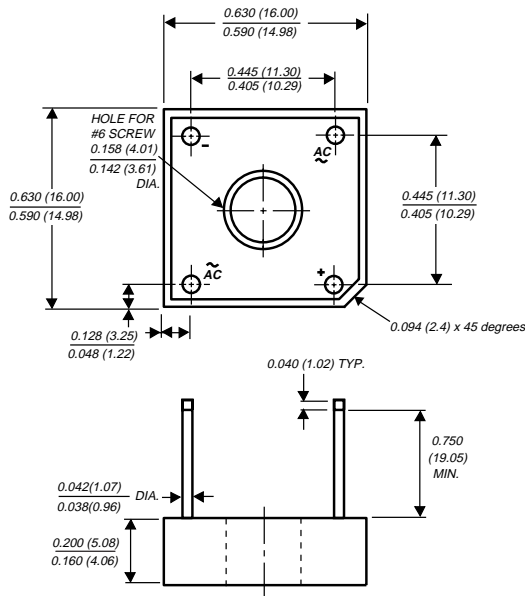

Polarity shown on side of case: Positive lead by beveled corner

Dimensions in inches and (millimeters)

FEATURES

- ◆ Plastic package has carries Underwriters Laboratory Flammability Classification 94V-0
- ◆ This series is UL listed under recognized under Component Index, file number E54214
- ◆ Glass passivated chip junctions
- ◆ High case dielectric strength of 1500 VRMS
- ◆ Typical I_R less than $0.5\mu A$
- ◆ High forward surge current capability
- ◆ Ideal for printed circuit boards
- ◆ High temperature soldering guaranteed: $260^\circ C/10$ seconds at 5lbs. (2.3 kg) tension

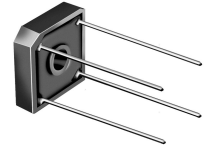

MECHANICAL DATA

Case: Molded plastic body over passivated junction

Terminals: Plated leads solderable per MIL-STD-750, Method 2026

Mounting Position: Any (NOTE 1)

Mounting Torque: 5.0 in. - lb. max.

Weight: 0.1 ounce, 2.8 grams

MAXIMUM RATINGS AND ELECTRICAL CHARACTERISTICS

Ratings at $25^\circ C$ ambient temperature unless otherwise specified.

	SYMBOLS	GBPC 6005	GBPC 601	GBPC 602	GBPC 604	GBPC 606	GBPC 608	GBPC 610	UNITS	
Maximum repetitive peak reverse voltage	V_{RRM}	50	100	200	400	600	800	1000	Volts	
Maximum RMS bridge input voltage	V_{RMS}	35	70	140	280	420	560	700	Volts	
Maximum DC blocking voltage	V_{DC}	50	100	200	400	600	800	1000	Volts	
Maximum average forward rectified output current at $T_C=50^\circ C$ (NOTE 1, 2) $T_A=40^\circ C$ (NOTE 3)	$I_{(AV)}$	6.0						3.0		Amps
Peak forward surge current single sine-wave superimposed on rated load (JEDEC Method)	I_{FSM}	175.0								Amps
Rating for fusing ($t < 8.3ms$)	I^2t	127.0								A^2sec
Maximum instantaneous forward voltage drop per leg at 3.0 Amperes	V_F	1.0								Volts
Maximum DC reverse current at rated DC blocking voltage per leg $T_A=25^\circ C$ $T_A=125^\circ C$	I_R	5.0						500.0		μA
Typical junction capacitance per leg (NOTE 4)	C_J	186.0				90.0			pF	
Typical thermal resistance per leg (NOTE 3) (NOTE 2)	$R_{\theta JA}$ $R_{\theta JC}$	22.0						7.3		$^\circ C/W$
Operating junction temperature range	T_J	-55 to +150								$^\circ C$
Storage temperature range	T_{STG}	-55 to +150								$^\circ C$

NOTES:

- (1) Bolt down on heat-sink with silicone thermal compound between bridge and mounting surface for maximum heat transfer with #6 screw
- (2) Unit mounted on $5.5 \times 6.0 \times 0.11"$ thick ($14 \times 15 \times 0.3cm$) Al. Plate
- (3) Unit mounted on P.C.B. at $0.375"$ (9.5mm) lead length with $0.5 \times 0.5"$ ($12 \times 12mm$) copper pads
- (4) Measured at 1 MHz and applied reverse voltage of 4.0 Volts

RATINGS AND CHARACTERISTICS CURVES GBPC6005 THRU GBPC610

FIG. 1 - DERATING CURVE OUTPUT RECTIFIED CURRENT

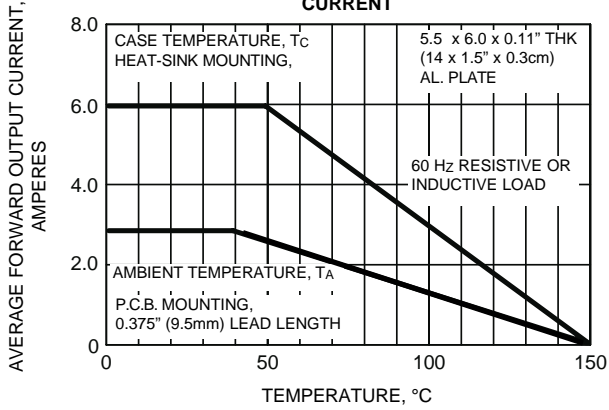

FIG. 2 - MAXIMUM NON-REPETITIVE PEAK FORWARD SURGE CURRENT PER LEG

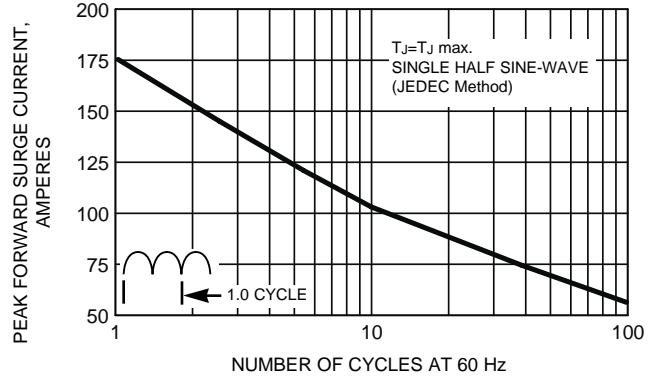

FIG. 4 - TYPICAL FORWARD CHARACTERISTICS PER LEG

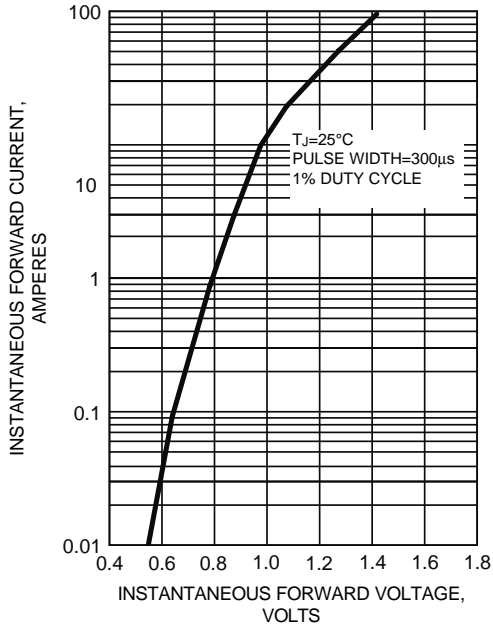

FIG. 3 - TYPICAL REVERSE LEAKAGE CHARACTERISTICS PER LEG

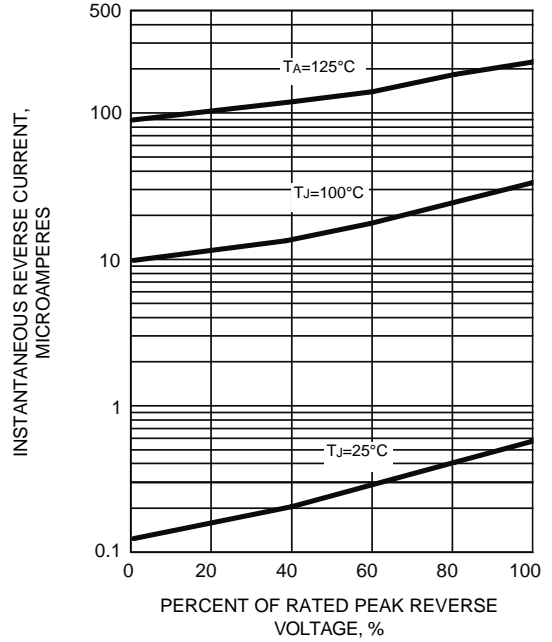

FIG. 5 - TYPICAL JUNCTION CAPACITANCE PER LEG

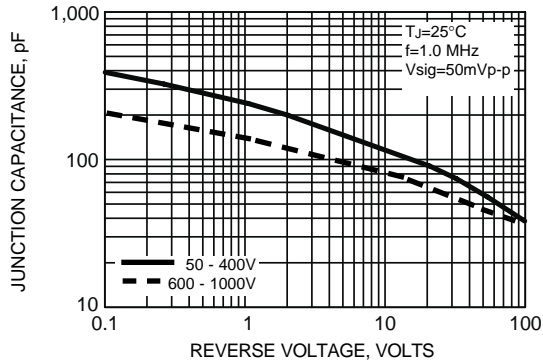

FIG. 6 - TYPICAL TRANSIENT THERMAL IMPEDANCE

