

Genesys Logic, Inc.

GL841 High Speed USB 2.0 Two-in-one Scanner Controller

SPECIFICATION Ver. 1.6

June 11, 2002

Genesys Logic, Inc.

10F, No.11, Ln. 155, Sec. 3, Peishen Rd., Shenkeng, Taipei, Taiwan

Tel: 886-2-2664-6655 Fax: 886-2-2664-5757

<http://www.genesyslogic.com>

INDEX

1	General Description.....	3
2	Feature.....	3
3	System Block Diagram	5
4	Function Block Diagram	6
5	Hardware description.....	7
6	Application Description	14
7	Command set descriptions	23
8	Package.....	48

1 GENERAL DESCRIPTION

Genesys Logic's single-chip GL841 (GeneScan™ series) is a high speed, high performance, low cost and rich scalability controller for scanner. It successfully integrates scanner function ASIC and USB 2.0 interface controller into one single-chip. With its high performance design architecture, GL841 is not only ready for supporting CIS or CCD image sensors (600dpi,1200dpi or 2400dpi resolution) that are used in flatbed or transparency scanners, but is able to co-work with uni-polar or bi-polar stepping motors. Advanced features of GL841 include five motor acceleration/ deceleration curve tables for high speed motor moving.

2 FEATURES

- Highly integrated scanner controller chip. (2-in-1; Scanner Controller and USB 2.0 Interface)
- USB 2.0 High Speed (480Mbit) compliance. (USB 2.0 High Speed logo certified)
- Design for sheetfed, flatbed and transparency scanner.
- 12 Mhz Low frequency clock input required for better EMI.
- Flexible 3.3V/5V power selection for pad I/O.
- Adjustable working speed for different usage.
- Fast operation speed. (0.3us/pixel, in 40MHz working clock)
- It costs only 12 seconds for 600dpi A4 size color scanning
- Available sensor types: 600, 1200 and 2400dpi color CIS or CCD.
- Support linear or stagger CCD , such as NEC , Toshiba or Sony CCD
- Support 48-Bits color (16-Bits gray level) scanning.
- Support color, fine Gray, fast gray and fast B/W scan for CCD.
- Support color,, gray, true gray and B/W scan for CIS.
- Support three scanning types :pixel by pixel(pixel rate), line by line(line rate) and RGB line by turns(line rate).
- 16 bits white/dark shading and 16-to-8 bits Gamma correction.
- Support digital average and hardware deletion pixel function for speeding up low resolution scan.

- Support hardware deletion type for DPI function (2400 to 1 DPI ,1 DPI decrement) .
- Programmable threshold level for B/W.
- Exposure time is adjustable (1 pixel time increment step).
- Scan width (scan area) control for horizontal line(1 pixel increment step).
- Support 256K*16, 256K*16*2 and 1M*16 bits EDO-DRAM.
- Support 5 acceleration/deceleration motor tables for detailed controllable high speed motor moving.
- Support controllable bipolar motor in full, half and quarter steps moving.
- Support controllable uni-polar motor in full and half steps moving.
- Build-in PWM control phase for uni-polar motor.
- Programmable dummy lines to resolve start/stop (discontinuous) problem.
- Watch dog protect for lamp, motor and ASIC.
- Lamp timeout (sleeping) control.
- Support 16 GPIO pins and 2 GPO pins.
- Output motor trigger signal under scanning for ADF.
- 2 Output ports for lamp(include flatbed and transparency with PWM) control.
- Input port for home sensor.
- Power on check status.
- Support LED Blinking.
- Support Back Scanning.

3 SYSTEM BLOCK DIAGRAM

A. USB 2.0 System Block Diagram

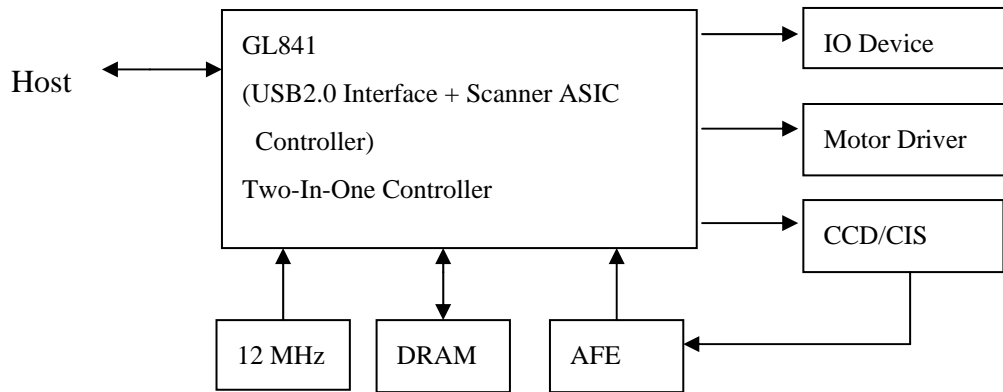

4 FUNCTION BLOCK DIAGRAM

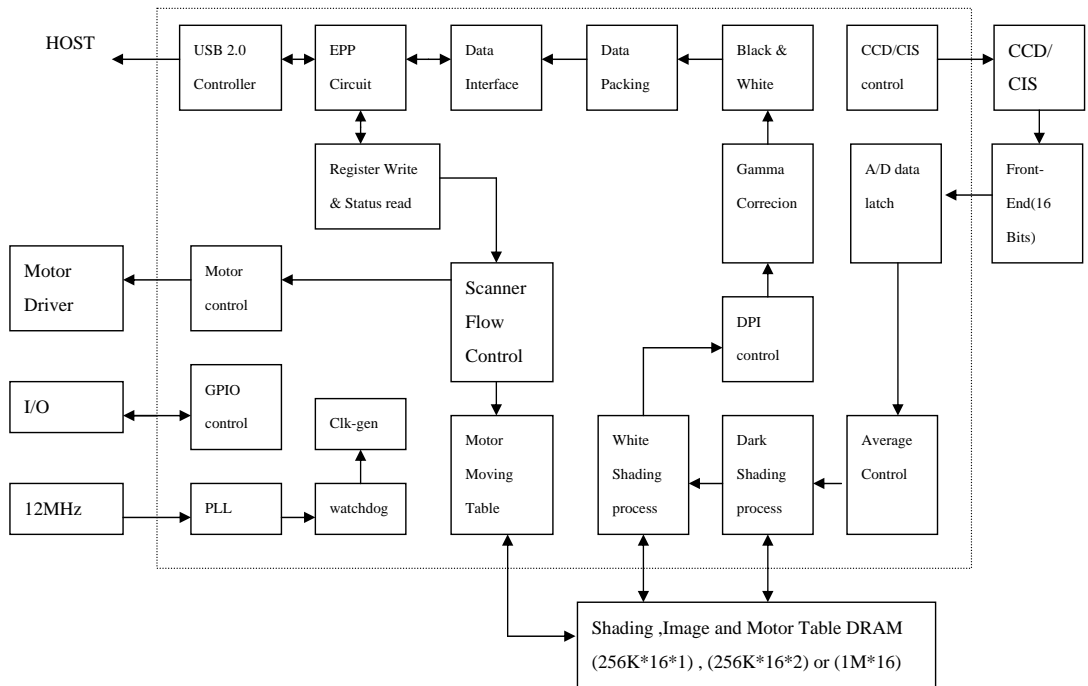

5 HARDWARE DESCRIPTION

5.1 Pins Assignment & Mode Definition:

	SC+USB2.0		ASIC I/O Cell
	TSTSEL[1:0]= 0		
1	AVCC1	P	
2	X2	I/O	
3	X1	I	
4	AGND1	P	
5	DVCC1	P	
6	DGND1	P	
7	GPIO1	I/O	hbd16rsc
8	GPIO2	I/O	hbd16rsc
9	GPIO3	I/O	hbd16rsc
10	GPIO4	I/O	hbd16rsc
11	GPIO5	I/O	hbd16rsc
12	GPIO6	I/O	hbd16rsc
13	GPIO7	I/O	hbd16rsc
14	GPIO8	I/O	hbd16rsc
15	GPIO9	I/O	hbd16rsc
16	GPIO10	I/O	hbd16rsc
17	GPIO11	I/O	hbd16rsc
18	GPIO12	I/O	hbd16rsc
19	GPIO13	I/O	hbd16rsc
20	GPIO14	I/O	hbd16rsc
21	VccCore1	P	
22	GndCore1	P	
23	GPIO15	I/O	hbd16rsc
24	GPIO16	I	hbd16rsc
25	Vccio1	P	
26	Gndio1	P	
27	MTR_SEL0	I	hbd16rsc
28	MTR_SEL1	I	hbd16rsc
29	LAMP_SW	O	hbd16rsc
30	XPA_SW	O	hbd16rsc
31	LED_B	O	hbd16rsc
32	MT_PH0	O	hbd16dhk
33	MT_PH1	O	hbd16dhk
34	MT_PH2	O	hbd16dhk
35	MT_PH3	O	hbd16dhk
36	MT_PH4	O	hbd16dhk
37	MT_PH5	I/O	hbd16rsc
38	MT_PH6	O	hbd16rsc
39	MT_PH7	O	hbd16rsc
40	OP0	I	hbd16dhk
41	OP1	I	hbd16dhk
42	OP2	I	hbd16dhk
43	OP3	I	hbd16dhk
44	OP4	I	hbd16dhk
45	OP5	I	hbd16dhk

46	OP6	I	hbd16dhk
47	OP7	I	hbd16dhk
48	Vccio2	P	
49	Gndio2	P	
50	SDO	I	hbd16dhk
51	SDI	O	hbd16dhk
52	VccCore2	P	
53	GndCore2	P	
54	SCLK	O	hbd16rsc
55	SEN	O	hbd16dhk
56	BSMP	O	hbd16rsc
57	VSMP	O	hbd16rsc
58	MCLK	O	hbd16rsc
59	CCD_TGX	O	hbd16rsc
60	CCD_CK1X	O	hbd16rsc
61	CCD_CK3X	O	hbd16rsc
62	CCD_CPX	O	hbd16rsc
63	Vccio3	P	
64	Gndio3	P	
65	CCD_RSX	O	hbd16rsc
66	HOME	I	hbd16uhk
67	CCD_CK2X	O	hbd16rsc
68	CCD_CK4X	O	hbd16rsc
69	CCD_TGG	O	hbd16rsc
70	CCD_TGB	O	hbd16rsc
71	CASY	O	hbd16rsc
72	RASY	O	hbd16rsc
73	NOEY	O	hbd16rsc
74	Vccio4	P	
75	Gndio4	P	
76	NWEY	O	hbd16rsc
77	CASX	O	hbd16rsc
78	RASX	O	hbd16rsc
79	NOEX	O	hbd16rsc
80	NWEX	O	hbd16rsc
81	ABUS0	O	hbd16rsc
82	VccCore3	P	
83	GndCore3	P	
84	ABUS1	O	hbd16rsc
85	ABUS2	O	hbd16rsc
86	ABUS3	O	hbd16rsc
87	ABUS4	O	hbd16rsc
88	ABUS5	O	hbd16rsc
89	ABUS6	O	hbd16rsc
90	Vccio5	P	
91	Gndio5	P	
92	ABUS7	O	hbd16rsc
93	ABUS8	O	hbd16rsc
94	ABUS9	O	hbd16rsc
95	DBUS0	I/O	hbd16dhk
96	DBUS1	I/O	hbd16dhk

97	DBUS2	I/O	hbd16dhk
98	DBUS3	I/O	hbd16dhk
99	DBUS4	I/O	hbd16dhk
100	DBUS5	I/O	hbd16dhk
101	DBUS6	I/O	hbd16dhk
102	DBUS7	I/O	hbd16dhk
103	Vccio6	P	
104	Gndio6	P	
105	DBUS8	I/O	hbd16dhk
106	DBUS9	I/O	hbd16dhk
107	DBUS10	I/O	hbd16dhk
108	DBUS11	I/O	hbd16dhk
109	DBUS12	I/O	hbd16dhk
110	DBUS13	I/O	hbd16dhk
111	DBUS14	I/O	hbd16dhk
112	DBUS15	I/O	hbd16dhk
113	VccCore4	P	
114	GndCore4	P	
115	TSTSEL0	I	hbd16dhk
116	TSTSEL1	I	hbd16dhk
117	EXTRST_	I	hbd8rteu
118	SUSPND	O	hbd8rted
119	DVCC0	P	
120	DGND0	P	
121	RPU	?	
122	AVDD	P	
123	DPF	I/O	
124	DPH	I/O	
125	DMF	I/O	
126	DMH	I/O	
127	AGND	P	
128	RREF	?	

Note: hbd16dhk is internal pulled down ; hbd16uhk is internal pulled up ; hbd16* is 16mA ; hbd8* is for 8mA

5.2 Pin Descriptions :

Support IO Ports		
GPIO1~16	B	General Purpose Input/ Output
MT_PH0~7	O	Bi-polar (3955): MT_PH7=PHASE_A MT_PH6=PHASE_B MT_PH5=D2A MT_PH4=D1A MT_PH3=D0A MT_PH2=D2B MT_PH1=D1B MT_PH0=D0B Bi-polar (2916 or 6219): MT_PH5=PHASE1 MT_PH4=PHASE2 MT_PH3=I11 MT_PH2=I01 MT_PH1=I12

GL841 USB 2.0 2-in-1 Scanner Controller

		MT_PH0=I02 Uni-polar(2003) : MT_PH3=PHASE A MT_PH2=PHASE B MT_PH1=PHASE /A MT_PH0=PHASE /B
MOTORTGO(GPIO13)	O	Output motor trigger for ADF scanning or GPIO13.
HOME	I	Sense carriage home position
CCD/CIS Control Signals		
CCD_CK1X	O	CCD Shift register clock1 or CIS clock output
CCD_CK2X	O	CCD Shift register clock2 or CIS clock output
CCD_CPX	O	CCD Clamp gate clock or CIS clock output
CCD_RSX	O	CCD Reset gate clock or CIS clock output
CCD_TGX	O	CCD Transfer gate clock for R channel or CIS Line start pulse
CCD_TGG	O	CCD Transfer gate clock for G channel
CCD_TGB	O	CCD Transfer gate clock for B channel
CCD_CK3X	O	CCD Shift register clock3
CCD_CK4X	O	CCD Shift register clock4
LAMP_SW	O	Flatbed lamp power control or CIS Red LED array control
XPA_SW	O	Transparency lamp power control or CIS Green LED array control
LED_B	O	CIS Blue LED array control
FRONT-END		
OP0~7	I	AFE digital data input.
SEN/SLOAD	O	Serial interface load pulse.
SCLK	O	Serial interface clock output.
SDI	O	Serial data output.
SDO	I	Serial data input.
BSMP/CDSCLK1	O	Wolfson type : Video sample synchronization pulse. Analog Device : CDS Reference level sampling clock.
VSMP/CDSCLK2	O	Wolfson type : Video sample synchronization pulse. Analog Device : CDS Data level sampling clock.
MCLK/ADCCLK	O	Wolfson type : Master clock. Analog Device : A/D Converter sampling clock.
DRAM		
DBUS0~15	B	DRAM data bus
ABUS0~9	O	DRAM address bus
RASX	O	DRAM RAS signal of first memory chip
CASX	O	DRAM CAS signal of first memory chip
NOEX	O	DRAM OE(output enable) signal of first memory chip
NWEX	O	DRAM WE signal of first memory chip
RASY	O	DRAM RAS signal of second memory chip
CASY	O	DRAM CAS signal of second memory chip
NOEY	O	DRAM OE(output enable) signal of second memory chip
NWEY	O	DRAM WE signal of second memory chip
Miscellaneous		

GL841 USB 2.0 2-in-1 Scanner Controller

TSTSEL0 TSTSEL1	I	To select mode: Normal mode = 00
MTR_SEL1 MTR_SEL0	I	MTR_SEL[1:0]=10 select Bi_polar 3955 MTR_SEL[1:0]=01 select Bi_polar 2916 OR 6219 MTR_SEL[1:0]=00 select Uni_polar 2003
IX1	I	Clock input for crystal (12MHz)
IOX2	O	Clock output for crystal
EXTRST_	I	Hardware reset input
POWER		
AVDD,AVCC1	P	Analog power input for USB2.0 transceiver 3.3V
AGND,AGND1	P	Analog ground input for USB2.0 transceiver
DVCC0,DVCC1	P	Digital power input for USB2.0 controller 3.3V
DGND0,DGND1	P	Digital ground input for USB2.0 controller.
VccCore1,VccCore2,VccCore3, VccCore4,DVCC1	P	Digital power input for scanner controller logic core 3.3V
GndCore1,GndCore2,GndCore3, GndCore4,DGND1,DGND0 GndIO1,GndIO2,GndIO3,GndIO4, GndIO5,GndIO6	P	Digital ground input for scanner controller.
VccIO1	P	for PIN7~PIN39 3.3V or 5V
VccIO2	P	For PIN40~PIN58 3.3V or 5V
VccIO3	P	for PIN59~PIN66 3.3V or 5V
VccIO4, VccIO5,VccIO6	P	for PIN67~116 3.3V or 5V
VCC0	P	for USB2.0 Pads 3.3V
USB Interface		
SUSPND	O	USB suspend indicator
RPU	-	3.3V Pull up control for DPF
DPF	B	Positive USB differential data (Full Speed)
DPH	B	Positive USB differential data (High Speed)
DMF	B	Negative USB Differential Data (Full Speed)
DMH	B	Negative USB Differential Data (High Speed)
RREF	-	510Ohm reference resistor input

5.3 Electrical Characteristics:

5.3.1 Absolute Maximum Ratings (Voltages referenced to GND)

SYMBOL	Description	MIN	MAX
DVCC0 DVCC1 AVDD AVCC1 VccCore1~4	DC supply voltage	-0.5V	+3.6V
VccIO1~6	DC supply voltage	-0.5V	+3.6V or +5.5V
V _I	DC input voltage	-0.5V	VCC+0.5V
V _{I/O}	DC input voltage range for I/O	-0.5V	VCC+0.5V
V _{AI/O}	DC input voltage for USB D+/D- pins	-0.5V	VCC+0.5V
V _{I/OZ}	DC voltage applied to outputs in High Z state	-0.5V	VCC+0.5V
V _{ESD}	static discharge voltage	4000V	

Note : VCC : VccCore,VccIO,DVCC,AVDD or AVCC1

5.3.2 DC Characteristics (Digital Pins) : 3.3 V Logic Core or Pads

SYMBOL	Description	MIN	TYP	MAX	UNIT
P _D	Power Dissipation				mA
DVCC0 DVCC1 AVDD AVCC1 VccCore1~4	Power Supply Voltage	3.1	3.3	3.6	V
VccIO1~6	Power Supply Voltage 3.3V	3	3.3	3.6	V
I _O	DC output sink current excluding D+/D-/VCC/GND	16 or 8			mA
V _{IL}	LOW level input voltage			0.9	V
V _{IH}	HIGH level input voltage	2.0			V
V _{TLH}	LOW to HIGH threshold voltage	1.3	1.43	1.56	V
V _{THL}	HIGH to LOW threshold voltage	1.3	1.43	1.56	V
V _{HYS}	Hysteresis voltage	-	0	-	V
V _{OL}	LOW level output voltage when I _{OL} =16mA			0.4	V
V _{OH}	HIGH level output voltage when I _{OH} =16mA	2.4			V
I _{OLK}	Leakage current for pads with internal pull up or pull down resistor			46	μA
R _{DN}	Pad internal pulldown resistor	72.8K	105.7K	167.4K	Ohms
R _{UP}	Pad internal pullup resistor	135.9K	167.8K	212.4K	Ohms

Note: hbd16dhk is internal pulled down ; hbd16uhk is internal pulled up ; hbd16* is 16mA ; hbd8* is for 8mA

5.3.2 DC Characteristics (Digital Pins) : 5.0 V Pads

SYMBOL	Description	MIN	TYP	MAX	UNIT
P _D	Power Dissipation				mA
VccIO1~6	Power Supply Voltage 5.0V	4.5	5.0	5.5	V
I _O	DC output sink current excluding D+/D-/VCC/GND	16			mA
V _{IL}	LOW level input voltage			0.9	V
V _{IH}	HIGH level input voltage	2.4			V
V _{TLH}	LOW to HIGH threshold voltage				V
V _{THL}	HIGH to LOW threshold voltage				V
V _{OL}	LOW level output voltage when I _{OL} =8mA			0.4	V
V _{OH}	HIGH level output voltage when I _{OH} =8mA	2.4			V
I _{OLK}	Leakage current for pads with internal pull up or pull down resistor			46	μA
R _{DN}	Pad internal pulldown resistor	104.6K	159.5K	206.6K	Ohms
R _{UP}	Pad internal pullup resistor	81.9K	103.2K	254.6K	Ohms

5.3.3 DC Characteristics (D+/D-)

SYMBOL	Description	MIN	TYP	MAX	UNIT
V _{OL}	D+/D- static output LOW(R _L of 1.5K to 3.6V)			0.3	V
V _{OH}	D+/D- static output HIGH (R _L of 15K to GND)	2.8		3.6	V
V _{DI}	Differential input sensitivity	0.2			V
V _{CM}	Differential common mode range	0.8		2.5	V
V _{SE}	Single-ended receiver threshold	0.2			V
C _{IN}	Transceiver capacitance			20	pF
I _{LO}	Hi-Z state data line leakage	-10		+10	μA
Z _{DRV}	Driver output resistance	28		43	Ohms

6 Application Description

6.1 System Clock

Internal PLL.

A. PLL : 12MHz input , 24,30,40 MHz output to internal system .

6.2 Pixel Clock

A. Normal mode

Scan mode 0:

(three-line-in or one-line-in)

- a. 12 system clock/pixel
- b. Chunky color(three line in),fine-gray or fine-line-art scan for CCD.
- c. Planar color scan (one line in) or Monochrome scan for CIS

B. Fast mode

Scan mode 4 (one line in) :

- a. 6 system clock/pixel.
- b. Planar color scan (one line in) or Monochrome scan.
- c. Fast-gray or fast-line-art scan for CCD.
- d. Planar color(one line in),gray, true gray or line-art scan for CIS.

C. Scan mode 5 (three line in):

- a. 15 system clock/pixel
- b. Chunky color(three line in),fine-gray or fine-line-art scan for CCD.
- c. Planar color scan (one line in) or Monochrome scan for CIS

D. Scan mode 6 (three line in):

- a. 18 system clock/pixel
- b. Chunky color(three line in),fine-gray or fine-line-art scan for CCD.
- c. Planar color scan (one line in) or Monochrome scan for CIS

Note : Chunky Color is R1G1B1,R2G2B2,R3G3B3,.....(three-line-in or pixel rate)

Planar Color is R1,R2,R3,.....;G1,G2,G3,.....;B1,B2,B3,.....(one-line-in or line rate)

CCD : Chunky color or planar color.

CIS : Planar color

6.3 Scan Speed

A. System clock = 30MHz :

a. Normal Mode : Chunky color, fine gray or fine line art scan.

(scan mode 0) $12 \times 33.333\text{ns/pixel} = 0.4\mu\text{s/pixel}$

(1). 600dpi : 2.160ms/line,15.163s/page.

(2). 1200dpi : 4.320ms/line,60.653s/page.

b. Fast Mode : Planar color , fast gray or fast line art scan.

(scan mode 4) $6 \times 33.333\text{ns/pixel} = 0.2\mu\text{s/pixel}$

(1). 600dpi : 1.08ms/line,7.582s/page for fast gray or fast line art.

(2). 1200dpi : 2.160ms/line,30.326s/page for fast gray or fast line art.

B. System clock = 40MHz :

a.Normal Mode : Chunky color,fine gray or fine line art scan.

$12 \times 25\text{ns/pixel} = 0.3\mu\text{s/pixel}$

(1). 600dpi : 1.620ms/line,11.372s/page.

(2). 1200dpi : 3.240ms/line,45.488s/page.

b.Fast Mode : Planar color , fast gray or fast line art scan.

$6 \times 25\text{ns/pixel} = 0.15\mu\text{s/pixel}$

(1). 600dpi : 0.81ms/line,5.616s/page for fast gray or fast line art.

(2). 1200dpi : 1.62ms/line,22.744s/page for fast gray or fast line art.

6.4 Fast scan for low DPI

Speed up CCD clocking rates allows speeding up scanning speed.

Such as Stagger CCD, you can speed up 2 times,4 times scanning time for low resolution as 600dpi scanner: if 75dpi speed up 4 times then $1.620\text{ms}/4=0.405\text{ms/line}$.

Scan speed is equal to 0.355s/page.

6.5 Scanning Type

Support three line in(parallel) for CCD, one line in for CIS two types.

A. CCD

a. Three line in :

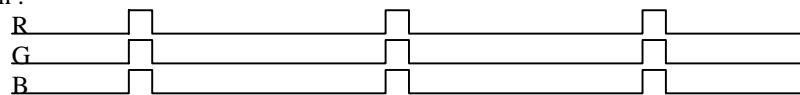

b.Line by line :

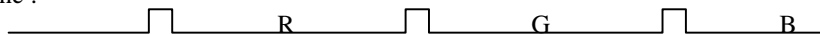

B. CIS

a. color scan :

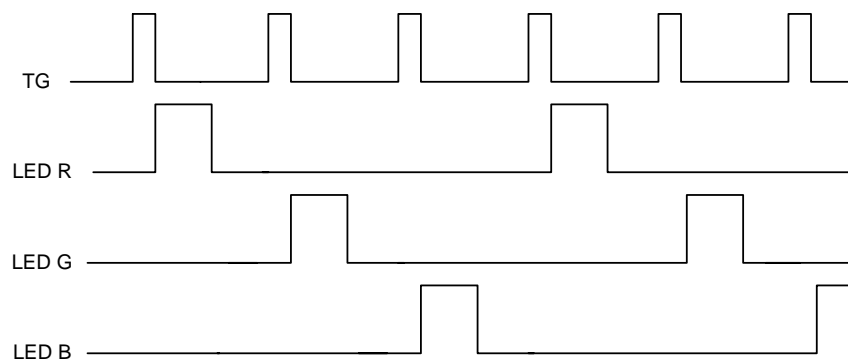

b. gray scan:

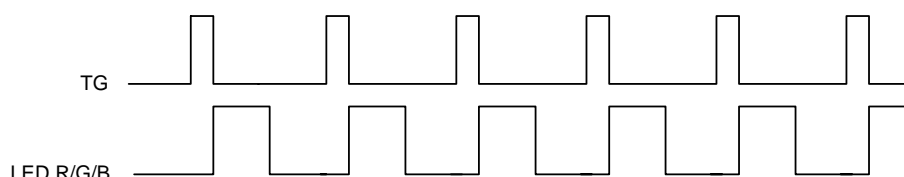

c. true gray scan:

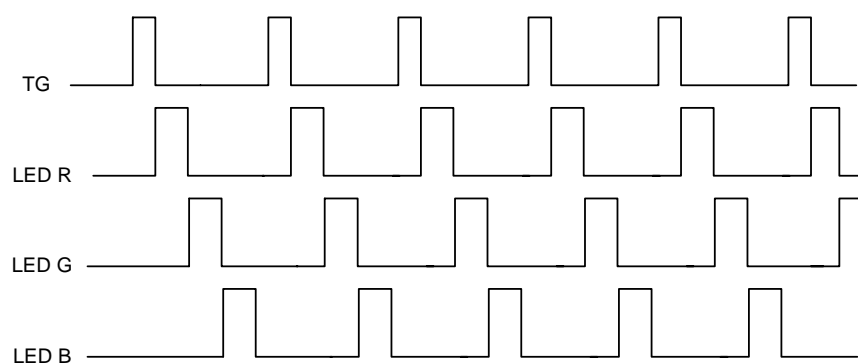

6.6 Image Sensor Timing

Can be programmed.

A. CCD : support 600,1200 or 2400 dpi CCD.

For example NEC, TOSHIBA, Sonyetc.

B. CIS : support 600,1200 or 2400 dpi CIS.

For example Toshiba , Canon.....etc.

6.7 Dummy Line

Support programmable dummy lines to resolve (overcome) Start/Stop problem.

You can insert dummy lines to reduce scanner stop and wait events (buffer full) or always non-stop.

A. Line base of dummy lines:

The range of dummy lines is 0 line ~ 15 lines.

B. Adjustable dummy line:

The range is CCD or CIS minimum shift out time to 2096k pixels time , which can be adjusted by 1 pixel time increment.

6.8 Analog Front End Timing

External 16 bits Front-End for Wolfson WM8192, WM8199.....etc.

6.9 Image Type

Support color, fine gray, fine line art, fast gray and fast line art scan.

Support color filters selection for gray and line art scans. The filters include Red, Green and Blue.

Note: The scan style of fine line art, fine gray or color are the same. So fine gray or fine line art scanning speed is slow.

The exposure time of fast line art or fast gray scan is shorter than fine line art or fine gray scan.

So, fast line art or fast gray scanning speed is high.

6.10 Bits Depth

16 x3 Bits true color , 16 bits gray level and one bit line art(Black & White).

Image data type : 16 bits , 8 bits and 1 bit data type.

6.11 Shading & Correction

a. White Shading & Dark Shading:

Internal white shading by pixel (16 bits resolution) and dark shading by pixel (16 bits resolution), can be enabled or disabled By S/W. The white shading curve is calculated by S/W.

Data arrangement: three line in mode: dark R1,white R1,dark G1,white G1,dark B1,white B1,
 dark R2,white R2,dark G2,white G2,dark B2,white B2,
 dark R3,white R3,dark G3,white G3,dark B3,white B3,.....

one line in mode:dark R1,white data R1,dark R2,white R2,dark R3, white R3...
 dark G1,white data G1,dark G2,white G2,dark G3,white G3...
 dark B1,white data B1,dark B2,white B2,dark B3,white B3...

White shading formula : $2000H \times \text{Target} / (W_n - D_n) = \text{White Gain data}$ ----- for 8 times system

White shading formula : $4000H \times \text{Target} / (W_n - D_n) = \text{White Gain data}$ ----- for 4 times system

For example : Target = 3FFFH $W_n = 2FFFH$ $D_n = 0040H$ and 8 times system operation

then White Gain = $2000H \times 3FFFH / (2FFFH - 0040H) = 2AE4H$ (1.34033 times)

b. Gamma Correction :

GAMMA correction table is calculated by S/W. The resolution is 16 bits gamma table.

Range: 0 to 64k (16 bits) input mapping to 0 to 255 (8 bits) output ;

Style : increment or decrement gamma curve style.

Note: If you bypass gamma correction , you can get 16 bits image data.

If you enable gamma correction , you can get 8 bits image data.

6.12 Threshold Level Setting

Can be programmed by S/W.

Range: 0 to 255 can be adjusted by one increment.

The threshold with bandwidth is in order to reduce image noise.

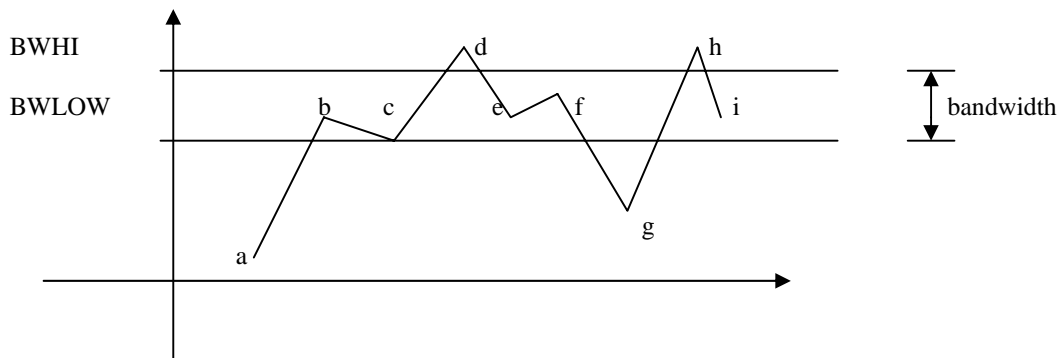

a,b,c,g : are black pixels
d,e,f,h,i : are white pixels

6.13 Exposure Time Adjustable

Maximum: 2096k pixels time

Adjustment step: 1 pixel time.

For Transparency scan,the exposure time can up to 2096k pixel time.

6.14 Scan Width control

Scan width control for horizontal line.

a.Support start pixel address, end pixel address and dummy pixel number setting

b.Maximum length: 64k pixels.

Minimum length: 1 pixel

6.15 Support built-in USB(2.0)

a.Two in one: USB2.0 + scanner controller.

6.16 DRAM Timing

Support 4Mx1 , x2 Bits (256Kx16) or 16M Bits (1Mx16) for EDO DRAM ; 4M or 8M Bits for SRAM ,as image buffer and calibration buffer timing.

You can select single or double DRAM for scanner. DRAM speed is 28ns and above for 30MHz system clock,25ns and above for 40MHz system clock.

6.17 Horizontal Resolution Adjustable for DPI Function

A. Digital deletion type :

The resolution from 1 DPI to 2400 DPI , can be adjusted by 1 DPI increment by S/W.

B. Digital average type :

Support 1/2,1/3,1/4,1/5,1/6,1/8,1/10,1/12,1/15 digital average function.

For example, 1200dpi scanner: 600dpi, 400dpi, 300dpi, 240dpi, 200dpi, 150dpi, 120dpi, 100dpi, 80dpi average function.

C. Support stagger CCD :

Support 1/2,1/4 resolution , such as NEC , Toshiba and Sony stagger CCD.

6.18 Vertical Resolution Adjustable for DPI Function

The resolution of motor speed control is 16 bits, therefore we can control vertical resolution.

By one dpi increment, the resolution can be from 1 DPI to 4800DPI for 1200DPI scanner; and 1 DPI to 9600 DPI for 2400dpi scanner.

Note: The resolution of quarter step can up to four times resolution.

6.19 Acceleration/Deceleration Five Table

The acceleration/deceleration slope tables are stored in DRAM, can be download by S/W.

The slope can be programmed by S/W for each table. Resolution is 16 bits pixel-time. The number of slope steps is 1~512 steps. There are five tables for motor moving. Three tables are for scanning and the others are for fast moving. The forward and backward steps can be programmed by S/W. The resolution is 16 bits pixel-time. The number of slope steps is 1~512 steps. You can adjust any non-linear curve.

Note: what is fast move? Such as move back to go- home or move to scan window in any position .

(1). Two tables go to scan:

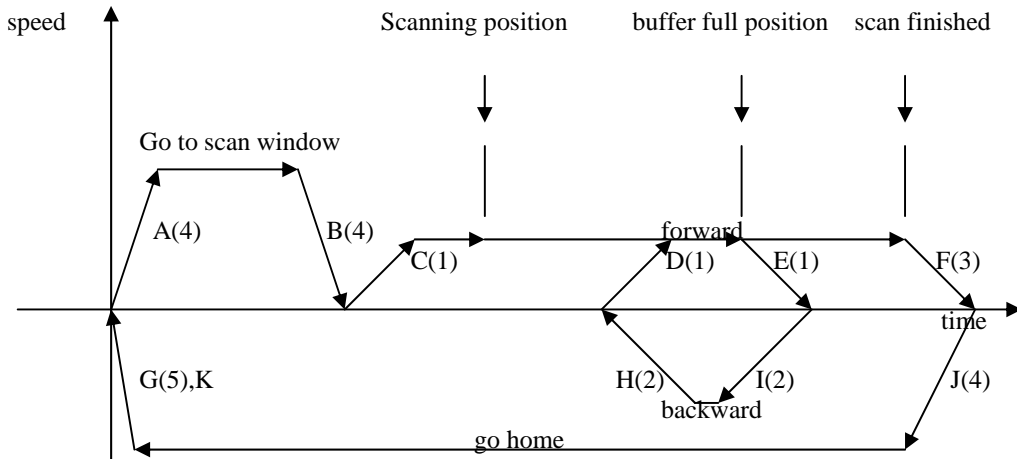

- A,J : table four (slope four) acceleration curve for fast moving.
- B : table four (slope four) deceleration curve for fast moving.
- C,D : table one (slope one) acceleration curve for scanning forward.
- F : table three (slope three) deceleration curve for scanning finish.
- I : table two (slope two) acceleration curve for scanning backward.
- H : table two (slope two) deceleration curve for scanning backward.
- G : table five (slope five) deceleration curve for go-home.
- K : touch home sensor deceleration curve for go-home.

(2). One tables go to scan:

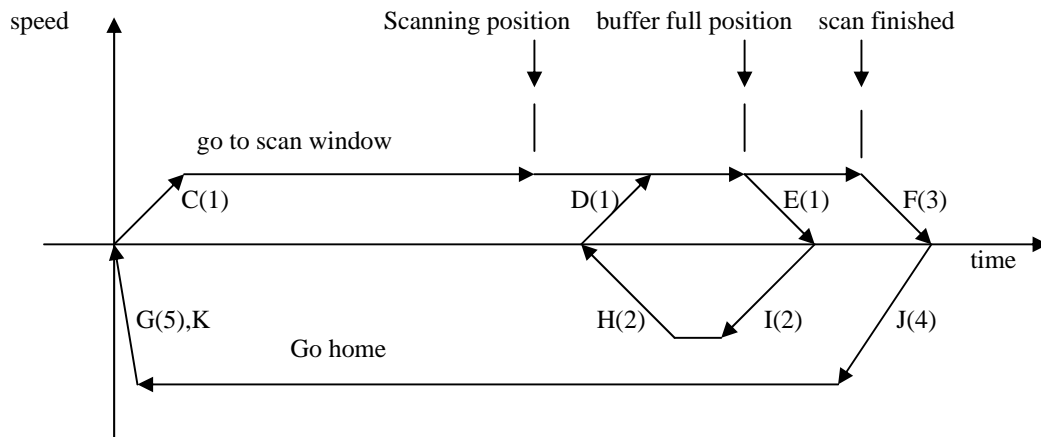

- J : table four (slope four) acceleration curve for fast moving.
- C,D : table one (slope one) acceleration curve for scanning forward.
- F : table three (slope three) deceleration curve for scanning finish.
- I : table two (slope two) acceleration curve for scanning backward.
- H : table two (slope two) deceleration curve for scanning backward.
- G : table five (slope five) deceleration curve for go-home.
- K : touch home sensor deceleration curve for go-home.

6.20 Stepping Motor Phase Control

There is 8 output control pins to control stepping motor. mtr_ph0~7 for bi-polar and mtr_ph0~3 for Uni-polar.

A. bi-polar :

- a. Support 2916 motor driver timing and 2916 compatible driver IC, such as L6219.
Include full, half and quarter step control.
- b. Support 3955 motor driver timing.
Include full, half, quarter and eighth step control.
- c. Support LB1939, LB1940 motor driver timing.
Include full and half step control.

B. uni-polar :

- a. Support 2003 motor driver timing and 2003 compatible driver IC.
- b. Include full step two phases on, full step single phase on and half step.
- c. PWM control, include frequency and duty control.

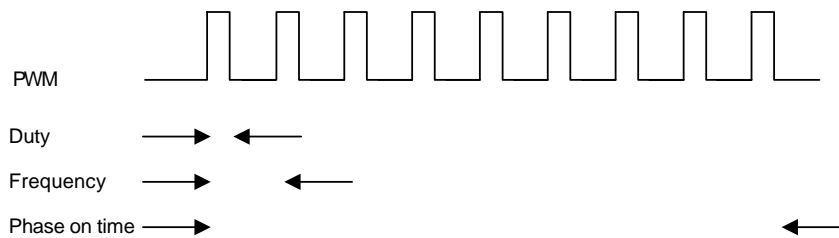

6.21 Watch-Dog Protection

This function can automatically reset the system to initial state, whenever the system is held (no access signal) beyond the time limit. Be able to enable or disable this function by S/W.

This function can protect motor power, lamp power and ASIC system.

Calculation formula : (30sec.) x (times setting) x (setting no.).

The range of setting no. is 1~15; the range of times setting is 0~1.

6.22 Lamp Timeout Control

This circuitry can automatically reset the lamp power, whenever the system is setting. Be able to enable or disable this function by S/W.

Calculation formula: (60sec.) x (times setting) x (setting no.).

The range of setting no. is 1~7; the range of times setting is 0~3.

6.23 Lamp Power Control

These are two power control ports for lamp. One is for Flatbed and the other is for XPA (Transparency or film).

The resolution of its PWM type is 8 bits. Duty range is 1/256~256/256.

Note : carrier frequency is (system clock)/256.

6.24 Sensor Input

The system support home sensor input port.

6.25 16 GPIO ports

You can set input or output for each GPIO pin of the GPIO1~16 separately.

Such as keypads inputs, document sensor for sheet-fed or motor power control...etc.

Note : there are two pins for special function. One is GPIO12 and the other is GPIO11.

GPIO12 : 1. Pull up by resistor to indicate that ASIC turn on lamp power whenever power on initial.

2. Pull down by resistor to indicate that ASIC turn off lamp power whenever power on initial.

3. This pin can control bi-polar motor driver 2916,6219,3966 or 3955 Vref in order to control I_{max}. current.

GPIO11 : This pin can control bi-polar motor driver 2916,6219,3966 or 3955 Vref in order to control I_{max}. current.

6.26 GPO17~18 ports or Motor MTR_PH6~7 two Phase

You can select 2 pins for 3955 2 phase MTR_PH6~7 output or GPO17~18 output.

6.27 GPO13 Port or Motor Trigger signal for ADF

Motor trigger signal for ADF motor moving ,It can be controlled under scanning condition.

6.28 Power on Check

The default status of the PWRBIT is reset. You can set the PWRBIT and then read back the status in order to check the power status. This operation is able to check first time power on or not.

6.29 RAM Test

S/W can test DRAM/SRAM IC by writing and reading back for checking.

6.30 LED Blinking

Support LED- blinking function. It is implemented in GPIO13~18 pins.

6.31 Support Back Scanning

Support forward or Backword scanning type.

7 COMMAND SET DESCRIPTION

Reg.	Bit7	Bit6	Bit5	Bit4	Bit3	Bit2	Bit1	Bit0
01	CISSET	DOGENB	DVDSET		M16DRAM	DRAMSEL	SHDAREA	S CAN
02	NOTHOME	ACDCDIS	AGOHOME	MTRPWR	FASTFED	MTRREV	HOMENEG	LONGCURV
03	LAMPDOG	AVEENB	XPASEL	LAMPPWR	LAMP TIM[3:0]			
04	LINEART	BITSET	AFEMOD[1:0]		FILTER[1:0]		FESET[1:0]	
05	DPIHW[1:0]		MTLLAMP[1:0]		GMMENB		MTLBASE[1:0]	
06	SCANMOD[2:0]			PWRBIT	GAIN4	OPTTEST[2:0]		
07					SRAMSEL	FASTDMA	DMASEL	DMARDWR
08		DECFLAG	GMMFFR	GMMFFG	GMMFFB	GMMZR	GMMZG	GMMZB
09	MCNTSET[1:0]		CLKSET[1:0]		BACKSCAN	ENHANCE	SHORTTG	NWAIT
0A								SRAMBUF
0B								
0C								
0D								CLRLNCNT
0E	SCANRESET							
0F	MOVE							
10	EXPR[15:8]							
11	EXPR[7:0]							
12	EXPG[15:0]							
13	EXPG[7:0]							
14	EXPB[15:8]							
15	EXPB[7:0]							
16	CTRLHI	TOSHIBA	TGINV	CK1INV	CK2INV	CTRLINV	CKDIS	CTRLDIS
17	TGMODE[1:0]		TGW[5:0]					
18	CNSET	DCKSEL[1:0]		CKTOGGLE	CKDELAY[1:0]		CKSEL[1:0]	
19	EXPDMY[7:0]							
1A			MANUAL3	MANUAL1	CK4INV	CK3INV	LINECLP	
1B								
1C	CK4MTGL	CK3MTGL	CK1MTGL	CKAREA	MTLWD	TGTIME[2:0]		
1D	CK4LOW	CK3LOW	CK1LOW	TGSGLD[4:0]				
1E	WDTIME[3:0]				LINESEL[3:0]			
1F	SCANFED[7:0]							
20	BUFSEL[7:0]							
21	STEPNO[7:0]							
22	FWDSTEP[7:0]							
23	BWDSTEP[7:0]							
24	FASTNO[7:0]							
25					LINCNT[19:16]			
26	LINCNT[15:8]							
Reg.	Bit7	Bit6	Bit5	Bit4	Bit3	Bit2	Bit1	Bit0

27	LINCNT[7:0]							
28	"GMMWRDATA"							
29	LAMP PWM[7:0]							
2A	RAMADDR[15:8]							
2B	RAMADDR[7: 0]							
2C					DPISET[11:8]			
2D	DPISET[7:0]							
2E	BWHI[7:0]							
2F	BWLOW[7:0]							
30	STRPIXEL[15:8]							
31	STRPIXEL[7:0]							
32	ENDPIXEL[15:8]							
33	ENDPIXEL[7:0]							
34	DUMMY[7:0]							
35					MAXWD[19:16]			
36	MAXWD[15:8]							
37	MAXWD[7:0]							
38	LPERIOD[15:8]							
39	LPERIOD[7:0]							
3A								FEWRDATA[8]
3B	FEWRDATA[7:0]							
3C	"RAMWRDATA"							
3D					FEEDL[19:16]			
3E	FEEDL[15:8]							
3F	FEEDL[7:0]							
40						HISPDFLG	MOTMFLG	DATAENB
41	PWRBIT	BUFEMPTY	FEEDFSH	SCANFSH	HOMESNR	LAMPSTS	FEBUSY	MOTORENB
42					VALIDWORD[19:16]			
43	VALIDWORD[15:8]							
44	VALIDWORD[7:0]							
45	"RAMRDDATA"							
46								FERDDATA[8]
47	FERDDATA[7:0]							
48					FEDCNT[19:16]			
49	FEDCNT[15:8]							
4A	FEDCNT[7:0]							
4B					SCANCNT[19:16]			
4C	SCANCNT[15:8]							
4D	SCANCNT[7:0]							
4E	"GMMRDDATA"							
Reg.	Bit7	Bit6	Bit5	Bit4	Bit3	Bit2	Bit1	Bit0

4F								
50			FERDA[5:0]					
51			FEWRA[5:0]					
52				RHI[4:0]				
53				RLOW[4:0]				
54				GHI[4:0]				
55				GLOW[4:0]				
56				BHI[4:0]				
57				BLOW[4:0]				
58	VSMP[4:0]					VSMPW[2:0]		
59	BSMP[4:0]					BSMP[2:0]		
5A	ADCLKINV	RLCSEL	CDSREF[1:0]		RLC[3:0]			
5B							GMMADDR[9:8]	
5C	GMMADDR[7:0]							
5D	HISPD[7:0]							
5E	DECSEL[2:0]			STOPTIM[4:0]				
5F	FMOVDEC[7:0]							
60				Z1MOD[20:16]				
61	Z1MOD[15:8]							
62	Z1MOD[7:0]							
63				Z2MOD[20:16]				
64	Z2MOD[15:8]							
65	Z2MOD[7:0]							
66	PHFREQ[7:0]							
67	STEPSEL[1:0]		MTRPWM[5:0]					
68	FSTPSEL[1:0]		FASTPWM[5:0]					
69	FSHDEC[7:0]							
6A	FMOVNO[7:0]							
6B	MULTFILM	GPOM13	GPOM12	GPOM11			GPO18	GPO17
6C	GPIO16	GPIO15	GPIO14	GPIO13	GPIO12	GPIO11	GPIO10	GPIO9
6D	GPIO8	GPIO7	GPOI6	GPIO5	GPIO4	GPIO3	GPIO2	GPIO1
6E	GPOE16	GPOE15	GPOE14	GPOE13	GPOE12	GPOE11	GPOE10	GPOE9
6F	GPOE8	GPOE7	GPOE6	GPOE5	GPOE4	GPOE3	GPOE2	GPOE1
70				RSH[4:0]				
71				RSL[4:0]				
72				CPH[4:0]				
73				CPL[4:0]				
74							CK1MAP[17:16]	
75	CK1MAP[15:8]							
76	CK1MAP[7:0]							
Reg.	Bit7	Bit6	Bit5	Bit4	Bit3	Bit2	Bit1	Bit0

77								CK3MAP[17:16]
78	CK3MAP[15:8]							
79	CK3MAP[7:0]							
7A								CK4MAP[17:16]
7B	CK4MAP[15:8]							
7C	CK4MAP[7:0]							
7D	CK1NEG	CK3NEG	CK4NEG	RSNEG	CPNEG	BSMPNEG	VSMPNEG	DLYSET
7E			GPOLED18	GPOLED17	GPOLED16	GPOLED15	GPOLED14	GPOLED13
7F	BSMPDLY[1:0]		VSMPDLY[1:0]		LEDCNT[3:0]			
80	VRHOME[1:0]		VRMOVE[1:0]		VRBACK[1:0]		VRSCAN[1:0]	
81								ROFFSET[8]
82	ROFFSET[7:0]							
83								GOFFSET[8]
84	GOFFSET[7:0]							
85								BOFFSET[8]
86	BOFFSET[7:0]							
87		YENB	YBIT	ACYCNRLC	ENOFFSET	LEDADD	CK4ADC	AUTOCONF

1. Reg : 01H (Read/Write)

Default : 00H

- B7: CISSET : set: CIS scan type.
: reset: CCD scan type.
- B6: DOGENB : set: enable watch dog of ASIC(set time out:Reg1E[7:4]).
: reset: disable.
- B5: DVDSET : set : enable shading (include whole line shading and
area shading two kinds).
: reset : disable shading.
- B4 : Reserved.
- B3: M16DRAM : set: to select 16M bits DRAM (1M * 16).
: reset: to select 4M or 8M bits DRAM(256*16).
- B2: DRAMSEL : set : the DRAM size is 4Mx2 (256kx16x2) bits.
: reset : the DRAM size is 4Mx1(256kx16x1) bits.
- B1: SHDAREA :set: enable shading area (depend on scan area and scan dpi).
: reset: shading area is whole line.
- B0: SCAN : set: enable scan process.
: reset: disable scan process.

2. Reg : 02H (Read/Write)

Default : 00H

- B7: NOTHOME : set: auto-go-home doesn't go back to home position.
: reset: go back to home position automatically.
- B6: ACDCDIS : set: disable forward/backward moving whenever buffer full.
: reset: enable forward/backward moving whenever buffer full.
- B5: AGOHOME : set: whenever scan is finished, carriage go home automatically.
: reset: disable auto-go-home function.
- B4: MTRPWR : set: turn on MOTOR power and phase.
: reset: turn off MOTOR power and phase.
- B3: FASTFED : set: enable two table for motor moving of the acceleration/deceleration.
: reset: disable two table, only use single table.

- B2:MTRREV : set: set motor reverse moving.
: reset: set motor forward moving.
- B1:HOMENEG : set: to indicate whenever home sensor change from high to low (falling edge) then motor is decelerated.
Reset: to indicate whenever home sensor change from low to high (rising edge) then motor is decelerated.
- B0:LONGCURV : set: the deceleration curve of the fast moving is table 5.
: reset: the deceleration curve of the fast moving is table 4.

3. Reg : 03H (Read/Write)

Default : 0CH

- B7:LAMPDOG : set: to start lamp sleeping mode(default on).
: reset: to disable lamp sleeping mode.
- B6:AVEENB : set: select dpi average function
: reset: select dpi deletion function.
- B5:XPASEL : set: select transparency lamp on.
: reset: select flatbed lamp on.
- B4:LAMPPWR : set: turn on LAMP power.
: reset: turn off LAMP power.
- B3~0:LAMPTIM[3:0] : lamp on time setting (default: 4)
The unit is minute.

4. Reg : 04H (Read/Write)

Default : 00H

- B7:LINEART : set: Black/White scan.
: reset: Color/Gray scan.
- B6:BITSET : set : 16 bits image data type (= word).
: reset : 8 bits image data type (= byte).
- B5~4: AFEMOD[1:0] : to indicate AFE operation mode.

Wolfson Type					
AFEMOD	SCANMOD	Description	CDS Available	Max Sample Rate	Timing Requirements
2	2	Slow color Pixel-by-pixel	Yes	5MSPS *3 channel	MCLK:VSMP Rate is 8:1
1	0,1,3,4,5,6	Color pixel-by-pixel	Yes	6.67MSPS *3 channel	MCLK:VSMP Rate is 6:1
0	0,1,4,5,6	Fast Mono	Yes	13.3MSPS *1 channel	MCLK:VSMP Rate is 3:1
Analog Device Type					
AFEMOD	SCANMOD	Description	CDS Available	Max Sample Rate	Timing Requirements
2	0,1,4,5,6	Slow color Pixel-by-pixel	Yes		MCLK:VSMP Rate is 3:1
1	0,1,2,3,4,5,6	Mono	Yes		MCLK:VSMP Rate is 2:1
0	0,1,2,3,4,5,6	Fast Mono	Yes		MCLK:VSMP Rate is 1:1

- B3~2:FILTER[1:0] : scan color type :
a.00: color
b.01: R
c.10: G
d.11: B
- B1~0:FESET[1:0] : front end operation type:
a.00: ESIC type 1.
b.01: ESIC type 2.
c.10: ADI type.
d.11: reserved.

5. Reg : 05H (Read/Write)

Default:00H

- B7~6: DPIHW[1:0] : set CCD/CIS resolution
 00=600dpi
 01=1200dpi
 10=2400dpi
 11=reserved.
- B5~4: MTLAMP[1:0] : to set times of the lamp time out.
 00: 1* LAMPTIM
 01: 2*LAMPTIM
 10: 4*LAMPTIM
 11: reserved.
- B3: GMMENB : set: enable gamma correction.
 : reset: bypass gamma correction.
- B2: Reserved.
- B1~0: MTLBASE[1:0] : to set output CCD pixel number under each system pixel time.
 00=1 CCD pixel/system pixel time.
 01=2 CCD pixels/system pixel time.
 10=3 CCD pixels/system pixel time.
 11=4 CCD pixels/system pixel time.

6. Reg : 06H (Read/Write)

Default:00H

- B7~5: SCANMOD[2:0] : set scan operation mode
 000:12 clocks/pixel ; normal mode operation for scanning.
 Include color(pixel rate),fine gray and fine line-art.
 001:12 clocks/pixel ; bypass mode operation for calibration.
 Include color(pixel rate) and fine gray.
 010:reserved.
 011:reserved.
 100:6 clocks/pixel ; fast mode operation.
 Include color(line rate),fast gray and fast line-art.
 101:15 clocks/pixel ; for 16 bits color output.
 110:18 clocks/pixel ; for 16 bits color output.
- B4: PWRBIT :When power on,set this bit.To indicate power has on.
 Default is reset.
- B3: GAIN4 : set: digital shading gain=4 times system.
 : reset: digital shading gain=8 times system.
 Note: If you want to get more precise image quality,you can set GAIN4 bit.
- B2~0: OPTTEST[2:0]: select ASIC operation type.
 000: set normal mode to capture AFE image.
 001: set DRAM bank,power on carriage initiated and
 ADF(motortgo) test for ASIC simulation.
 010: pixel count pattern for ASIC image test.
 011: line count pattern for ASIC image test.
 100: counter and adder test for ASIC simulation test.

7. Reg : 07H (Read/Write)

Default:00H

- B3:SRAMSEL : set: DMA access for SRAM.
 : reset: DMA access for DRAM.
- B2:FASTDMA : set: 2clocks/access,that is to say 2clocks/16bits or 2clocks/8bits for DMA access.
 : reset: 4clocks/access,that is to say 4clocks/16bits or 4clocks/8bits for
 DMA access.
- B1:DMASEL : set: DMA access DRAM under command mode.
 : reset: MPU access DRAM under command mode.
- B0:DMARDWR : set: DMA read DRAM under command mode.

: reset: DMA write DRAM under command mode.

Note: DMA operation can be processed under CPU and DMA type.

8. Reg : 08H (Read/Write)

Default:00H

- B6: DECFLAG : set :gamma table is decrement type
: reset :gamma table is increment type.
- B5: GMMFFR : set: to indicate that red channel Gamma table address FFH is special value.
- B4: GMMFFG : set: to indicate that red channel Gamma table address FFH is special value.
- B3: GMMFFB : set: to indicate that red channel Gamma table address FFH is special value.
- B2: GMMZR : set: to indicate that red channel Gamma table address 00H is special value.
- B1: GMMZG : set: to indicate that green channel Gamma table address 00H is special value.
- B0: GMMZB : set: to indicate that blue channel Gamma table address 00H is special value.

9. Reg : 09H (Read/Write)

Default:00H

- B7~6: MCNTSET[1:0] : to select the unit of motor table counter.
00: pixel count.
01:system clock*2.
10:system clock*3.
11:system clock*4.
- B5~4: CLKSET[1:0] : to select the system clock frequency.
00: 24MHz
01: 30MHz
10: 40MHz
11:48MHz.
- B3: BACKSCAN : set: to enable backward scan function.
: reset: to select forward scan function.
- B2: ENHANCE : set: to enhance EPP interface speed for USB2.0
: reset: to select normal EPP interface speed for USB2.0
- B1: SHORTTG : set: enable short CCD SH(TG) period for film scanning.
- B0: NWAIT : set: to delay nWait (H_BUSY) one clock.

10. Reg : 09H (Read/Write)

Default:00H

- B0: SRAMBUF :set: to select external SRAM as the image buffer.
:reset: to select external DRAM as the image buffer.

11. Reg : 0DH (Write)

Command : scanner command.

- B0: CLRLNCNT : set: to clear SCANCNT(Reg4B,Reg4C,Reg4D).
: reset: don't clear SCANCNT.

Note: For each time scanning , you must clear SCANCNT before starting process.

12. Reg : 0EH (Write)

Command : scanner software reset.

It can initiate AISC system, including lamp and motor,
Control registers, internal circuit and status, but not including tables in
DRAM, like gamma table, shading table and acceleration/deceleration table.

Note: In normal condition, it is unnecessary to reset scanner , unless the scanner is out of control.

13. Reg : 0FH (Write)

Command : motor moving.

Start motor forward/backward moving.

14. Reg : 10,11H (Read/Write)

Default : 00H,00H

EXPR[15:0]: Red-LED array of CIS or Red channel TG of CCD exposure time setting.
 Note: can not be programmed to logic zero.

15. Reg : 12H,13H (Read/Write)

Default : 00H,00H

EXPG[15:0]: Green-LED array of CIS or Green channel TG of CCD exposure time setting.
 Note: can not be programmed to logic zero.

16. Reg : 14H,15H (Read/Write)

Default : 00H,00H

EXPB[15:0]: Blue-LED array of CIS or Blue channel TG of CCD exposure time.
 Note: can not be programmed to logic zero.

17. Reg : 16H (Read/Write)

Default : 32H

- B7:CTRLHI : set: CCD CP & RS are high under TG high position.
 : reset: CCD CP & RS are low under TG high position.
- B6: TOSHIBA : set: to indicate the image sensor is TOSHIBA CIS.
- B5:TGINV : set: to reverse CCD TG.
 : reset: don't reverse.
- B4:CK1INV : set: to reverse CCD Clock 1.
 : reset: don't reverse.
- B3:CK2INV : set: to reverse CCD Clock 2.
 : reset: don't reverse.
- B2:CTRLINV : set: to reverse CCD CP & RS.
 : reset: don't reverse.
- B1:CKDIS : set: disable CCD TG position Clock 1/2 signals.

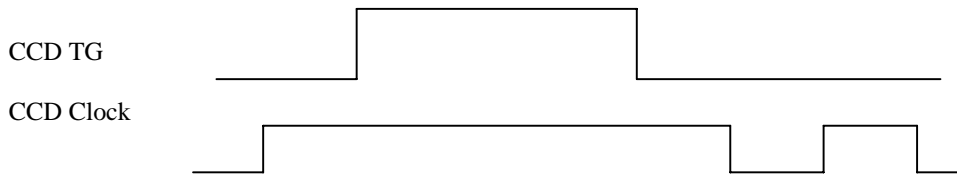

: reset: enable CCD TG position Clock 1/2 signals.

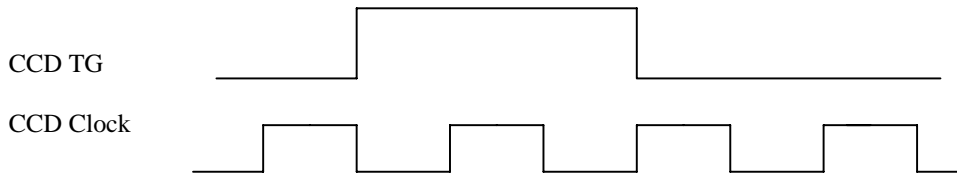

B0:CTRLDIS : set: disable CCD TG position CP & RS signals.

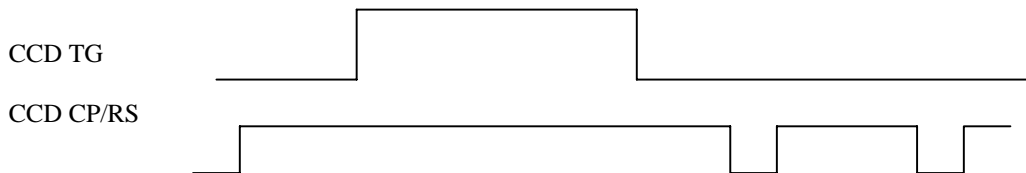

: reset: enable CCD TG position CP & RS signals.

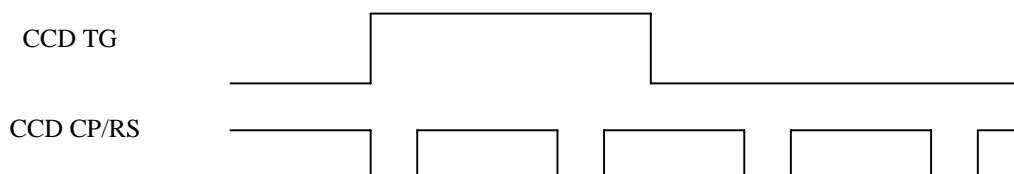
**18. Reg : 17H (Read/Write)**

Default : 14H

B7~6: TGMODE[1:0] : to set CCD TG mode.
 00: without dummy line CCD TG type.
 01: with reflectional document scanning type.
 10: with transparency scanning type.
 11: TGMODE=2 for simulation.

B5~0: TGW[5:0] : to set CCD TG width.

Note: Can not be programmed to logic zero.

19. Reg : 18H (Read/Write)

Default : 00H

B7 : CNSET : set : TG and clock set to Canon CIS style.
 : reset: TG and clock is non-Canon CIS style.
 B6~5 : DCKSEL : 00 one time CCD Clocks speed for dummy line.
 01 two times CCD Clocks speed for dummy line.
 10 three times CCD Clocks speed for dummy line.
 11 four times CCD Clocks speed for dummy line.
 B4 : CKTOGGLE: set : half cycle per pixel for CCD Clock 1/2.
 : reset : one cycle per pixel
 B3~2 : CKDELAY: 00 no delay
 01 delay one system clock for CCD Clock 1/2.
 10 delay two systems clock for CCD Clock 1/2.
 11 delay three systems clock for CCD Clock 1/2.
 B1~0 : CKSEL : 00 one time CCD Clock speed for capture image.
 01 two times CCD Clock speed for capture image.
 10 three times CCD Clock speed for capture image.
 11 four times CCD Clock speed for capture image.

Note : CCD Clock speed up limitation :

- | | |
|----------------------------------|--|
| 1. SCANMOD=0,1 : 12 clocks/pixel | a. toggle CCD : be able to speed up 1,2,3,4 times.
b. non-toggle CCD : be able to speed up 1,2,3 times. |
| 2. SCANMOD=2 : reserved. | |
| 2. SCANMOD=3 : reserved. | |
| 3. SCANMOD=4 : 6 clocks/pixel | a. toggle CCD : be able to speed up 1,2,3 times.
b. non-toggle CCD : can not speed up. |
| 4. SCANMOD=5 : 15 clocks/pixel | a. toggle CCD : be able to speed up 1,2,3,4 times.
b. non-toggle CCD : be able to speed up 1,2,3 times. |
| 5. SCANMOD=6 : 18 clocks/pixel | a. toggle CCD : be able to speed up 1,2,3,4 times.
b. non-toggle CCD : be able to speed up 1,2,3,4 times. |

20. Reg : 19H (Read/Write)

Default : 00H

EXPDMY[7:0] : to set dummy line exposure time (unit = 256 pixels time) or CIS LED array turn-on time.

Note: the unit is pixel time.

CIS : LINESEL =0 full dpi.
 =1 1/2 dpi
 =2 1/3 dpi

.....
 =15 1/16 dpi

CCD : LINESEL =0 no dummy line.
 =1 1 dummy line.
 =2 2 dummy lines.

.....
 =15 15 dummy lines.

Note : CIS can be implemented dummy line by motor move method,not dummy lines.

26. Reg : 1FH (Read/Write)

Default : 00H

SCANFED[7:0]: move to scanning position by table one under two table operation.

Note: can not be programmed to logic zero.

27. Reg : 20H (Read/Write)

Default : 00H

BUFSEL[7:0] : to set buffer condition (unit = 4k word).

Scanner execute backward/forward moving whenever buffer full.

If MAXWD < buffer condition , then motor move forward to scan.

28. Reg : 21H (Read/Write)

Default : 00H

STEPNO[7:0]: to set scanning forward slope curve of the acceleration/deceleration (table one slope).

Note: can not be programmed to logic zero.

29. Reg : 22H (Read/Write)

Default : 00H

FWDSTEP[7:0] : to set steps number of the forward steps.

Note: can not be programmed to logic zero.

30. Reg : 23H (Read/Write)

Default : 00H

BWDSTEP[7:0] : to set steps number of the backward steps.

Note: can not be programmed to logic zero.

31. Reg : 24H (Read/Write)

Default : 00H

FASTNO[7:0]: to set scanning backward slope curve of the acceleration/deceleration (table two slope).

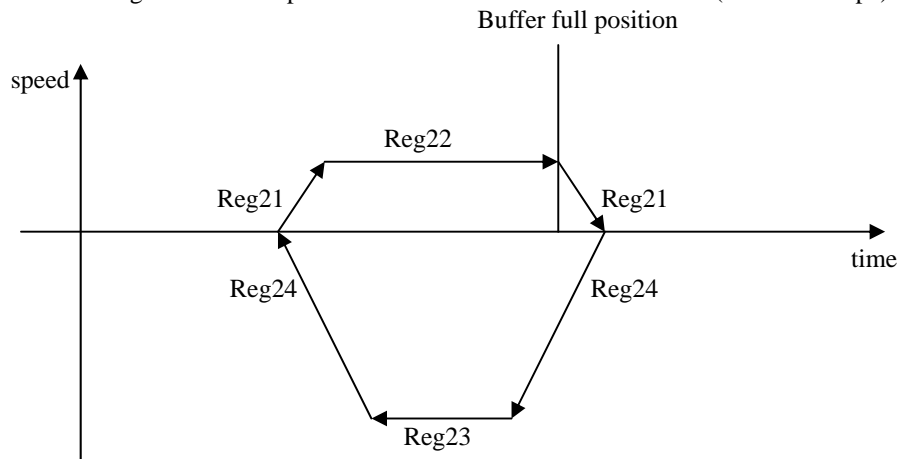

Note: can not be programmed to logic zero.

32. Reg : 25H,26H,27 H (Read/Write)

Default : 00H,00H,00H

LINCNT[19:0]: to set the scan lines number.

Note: can not be programmed to logic zero.

33. Reg : 28H (Read/Write)

Default : 00H

GMMWRDATA : this port to write gamma table.

34. Reg : 29H (Read/Write)

Default : FFH

LAMPPWM[7:0] : to set PWM duty for lamp power control.

0: 1/256 duty.

1: 2/256 duty.

.....

255:256/256 duty.

35. Reg : 2AH,2BH (Read/Write)

Default : 00H.00H

RAMADDR[15:0] : to set DRAM start address to access data.

note: IRAM_A[19:0]={RAMADDR[15:0],4'b0000}.

36. Reg : 2CH,2DH (Read/Write)

Default : 00H,00H

DPISSET[10:0] : set resolution of DPI for average type or deletion type.

A. average type : digital average function support 1/2,1/3,1/4,1/5,1/6,1/8,1/10,1/12,1/15.

a. 2400 dpi scanner : can set 1200,800,600,480,400,300,240,200,160 dpi.

b. 1200 dpi scanner : can set 600,400,300,240,200,150,120,100,80 dpi.

c. 600 dpi scanner : can set 300,200,150,120,100,75,60,50 and 40 dpi.

B. deletion type : 2400,1200 or 600dpi to 1 dpi setting decrement by one dpi.

Note: can not be programmed to logic zero.

37. Reg : 2EH (Read/Write)

Default : 00H

BWHI[7:0] : to set Black & White threshold high level.

38. Reg : 2FH (Read/Write)

Default : 00H

BWLOW[7:0] : to set Black & White threshold low level.

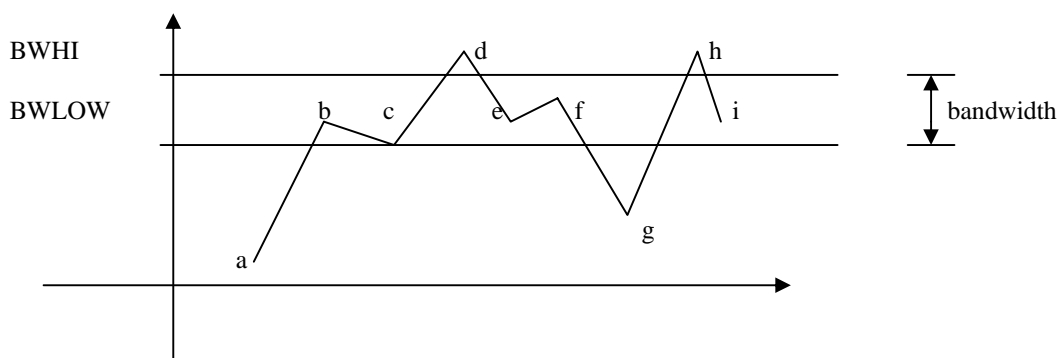

a,b,c,g : are black pixels
 d,e,f,h,i : are white pixels

39. Reg : 30H,31H (Read/Write)

Default : 00H,00H

STRPIXEL[15:0] : to set the begin pixel position (unit : pixel count).
 $STRPIXEL=(TGW+2*TGSHLD)+Begin\ pixels\ number.$
 Note: can not be programmed to logic zero.

40. Reg : 32H,33H (Read/Write)

Default : 00H,00H

ENDPIXEL[15:0] : to set the end pixel position (unit : pixel count).
 $ENDPIXEL=(TGW+2*TGSHLD)+End\ pixels\ number.$
 Note: can not be programmed to logic zero.

41. Reg : 34H (Write)

Default : 00H

DUMMY[7:0] : to set the CCD dummy & optical black pixels position (unit : pixel count).
 Note : Reg30,31,32,33 and 34 setting rule.

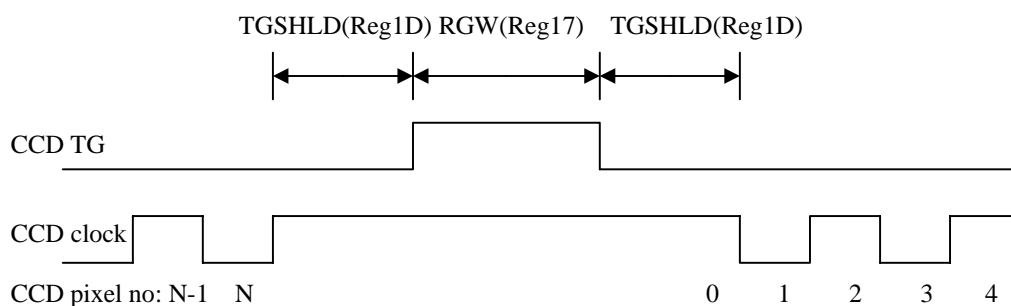

For example begin pixel is 65 ,end pixel is 100 and CCD dummy pixel is 64,
 Then $STRPIXEL=(TGW+2*TGSHLD)+65.$
 $ENDPIXEL=(TGW+2*TGSHLD)+100.$
 $DUMMY=(TGW+2*TGSHLD)+64.$
 Note: can not be programmed to logic zero.

42. Reg : 35H,36H,37H (Read/Write)

Default : 00H,00H,00H

MAXWD[19:0] : to set maximum word size per line for ASIC estimation.
 If usable buffer size < MAXWD,then buffer is full.The scanner execute forward and Backward moving.

43. Reg : 38H,39H (Read/Write)

Default : 15H,18H

LPERIOD[15:0] : to set Line period(or exposure time) for CCD.
 Unit : pixel count
 Note: can not be programmed to logic zero.

44. Reg : 3AH,3BH (Read/Write)

Default : 00H,00H

FEWRDATA[8:0] : This port is used to write data to control register of front-end.

45. Reg : 3CH (Read/Write)

Default : 00H

RAMWRDATA : This port is used to write data to DRAM.

46. Reg : 3DH,3EH,3FH (Read/Write)

Default : 00H,00H,00H

FEEDL[19:0] : to set feeding steps number of motor move.

Note: can not be programmed to logic zero.

47. Reg : 40H (Read)

B2:HISPDFLG : set: motor is high-speed moving.

B1:MOTMFLG : set: motor is moving.

: reset: motor is stop.

B0:DATAENB : set: scanner is scanning mode.

Reset: scanner is command mode.

48. Reg : 41H (Read)

B7:PWRBIT : To indicate power status.

Power on initial,PWRBIT=0;

B6:BUFEMPTY : set: To indicate that the image buffer is empty.

: reset: To indicate that the image buffer is not empty.

B5:FEEDFSH : set: To indicate that motor feeding is finished.

: reset: To indicate that motor feeding is not finished.

B4:SCANFSH : set: To indicate that scan is finished.

: reset: To indicate that scan is not finished.

B3:HOMESNR : set: home sensor is off (is home position).

: reset: home sensor is on (is not home position).

B2:LAMPSTS : set: lamp is on.

: reset: lamp is off.

B1:FEBUSY : set: front end is busy and can not read/write again.

: reset: front end is ready and be able to read/write again.

B0:MOTORENB : set: motor is processing.

: reset: motor is not processing.

49. Reg : 42H,43H,44H (Read)

VALIDWORD[19:0] : to indicate available words to read out in the image buffer of DRAM.

50. Reg : 45H (Read)

RAMRDATA : this port for read DRAM data.

51. Reg : 46H,47H (Read)

FERDDATA[8:0] : this port is used to read out data from front-end control register.

52. Reg : 48H,49H,4AH (Read)

FEDCNT[19:0] : to read motor feeding steps number.

For example,if you have set moving steps no. and execute moving command.

You can read out steps no. moved.

53. Reg : 4BH,4CH,4DH (Read)

SCANCNT[19:0] : to read scanner finished lines number.

54. Reg : 4EH (Read)

GMMRDATA : this port to read back the gamma table.

55. Reg : 50H (Read/Write)

Default : 00H

FERDA[5:0] : this port is read address setting for Front End control register read.

56. Reg : 51H (Read/Write)

Default : 00H

FEWRA[5:0] : this port is write address setting for Front End control register write.

57. Reg : 52H,53H (Read/Write)

Default : 00H,00H

RHI[4:0] : to latch R channel high byte data of AFE.

RLOW[4:0] : to latch R channel low byte data of AFE.

58. Reg : 54H,55H (Read/Write)

Default : 00H,00H

GHI[4:0] : to latch G channel high byte data of AFE.

GLOW[4:0] : to latch G channel low byte data of AFE.

59. Reg : 56H,57H (Read/Write)

Default : 00H,00H

BHI[4:0] : to latch B channel high byte data of AFE.

BLOW[4:0] : to latch B channel low byte data of AFE.

(1). Color, fine gray or fine line-art : 12 phase/pixel

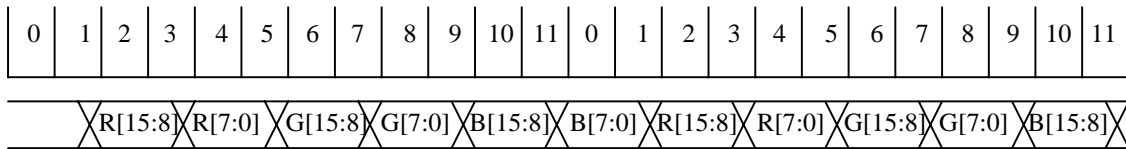

RHI = 01H RLOW = 03H
 GHI = 05H GLOW = 07H
 BHI = 09H BLOW = 11H

(2).Fast gray or fast line-art : 6 phase/pixel



RHI = 02H RLOW = 05H

60. Reg : 58H (Read/Write)

Default : 00H

B7~3:VSMP[4:0] : to set the rising edge position of image sampling for AFE.

B2~0:VSMPW[2:0] : to set the pulse width of image sampling.

(1). Color, fine gray or fine line-art : 12 phase/pixel

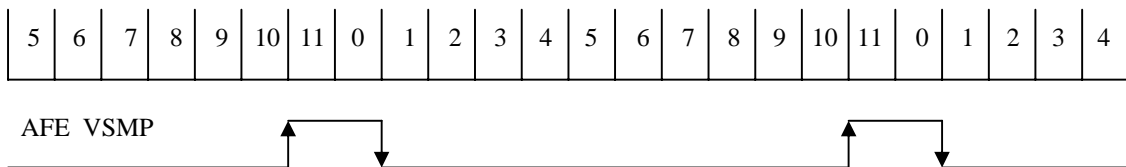

Reg58=52H : VSMP[4:0]=10H VSMPW[2:0]=2H

(2).Fast gray or fast line-art : 6 phase/pixel

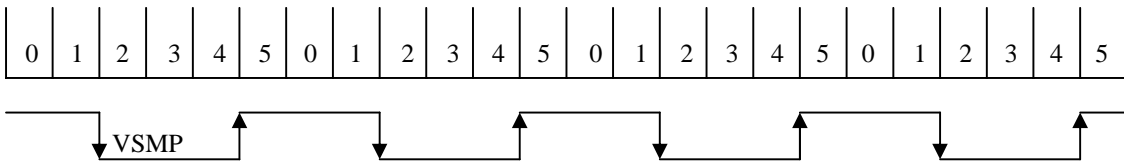

Reg58=0BH : VSMP[4:0]=01H VSMPW=3H

61. Reg : 59H (Read/Write)

Default : 00H

B7~3:BSMP[4:0] : to set the rising edge position of dark voltage sampling for AFE.

B2~0:BSMPW[2:0] : to set the pulse width of dark voltage sampling.

(1). Color, fine gray or fine line-art: 12 phase/pixel

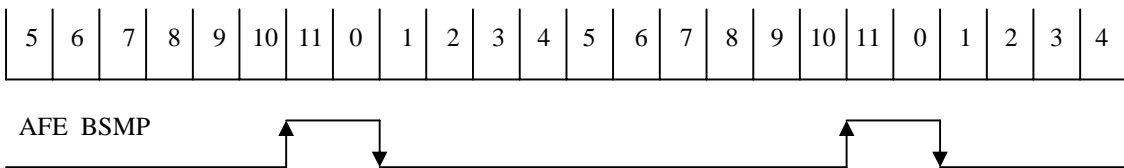

Reg59=52H : BSMP[4:0]=10H BSMPW[2:0]=2H

(2).Fast gray or fast line-art : 6 phase/pixel

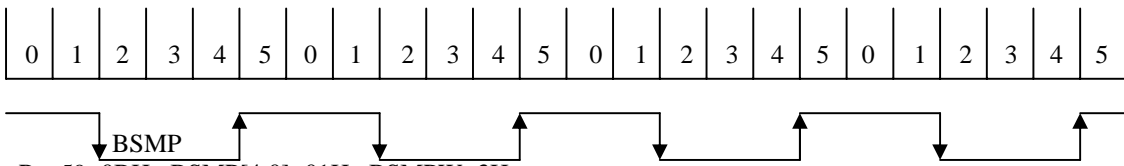

Reg59=0BH : BSMP[4:0]=01H BSMPW=3H

62. Reg : 5AH (Read/Write)

Default : C0H

B7 : ADCLKINV : set: ADC clock reverse.

B6 : RLCSEL : set: select reset level clamp on a pixel-by-pixel basis.

: reset: don't select.

B5~4 : CDSREF[1:0] : to set the front-end CDSREF for line rate scanning type.

B3~0 : RLC[3:0] : to set the front-end RLC for line rate scanning type.

63. Reg : 5BH,5CH (Read/Write)

Default : 00H,00H

GMMADDR[9:0]: to set gamma access start address.

64. Reg : 5DH (Read/Write)

Default : 00H

HISPD[7:0] : to set change of the moving speed during moving.

Note: can not be programmed to logic zero.

65. Reg : 5EH (Read/Write)

Default : 00H

B7~5:DECSEL[2:0] :select deceleration steps whenever go home.

000:1 steps deceleration

001:2 steps deceleration

010:4 steps deceleration

011:8 steps deceleration

- 100:16 steps deceleration
- 101:32 steps deceleration
- 110:64 steps deceleration
- 111:128 steps deceleration

B4~0:STOPTIM[4:0] :select acceleration/deceleration stop time.

Note: STOPTIM simulation for ASIC must be set to tptime=6,7.

Can not be programmed to logic zero.

66. Reg : 5FH (Read/Write)

Default : 00H

FMOVDEC[7:0] : to set go-home fast move deceleration slope steps (table five slope).

Note: can not be programmed to logic zero.

67. Reg : 60H,61H,62H (Read/Write)

Default : 00H,00H,00H

Z1MOD[20:0]: to set the slope curve of acceleration/deceleration table mode value

Under buffer full moving.

Note: It should be more than LPERIOD.

68. Reg : 63H,64H,65H (Read/Write)

Default : 00H,00H,00H

Z2MOD[20:0]: to set the slope curve of acceleration/deceleration mode value

Under first time moving to scanning .

Note: It should be more than LPERIOD.

(1). Two table moving :

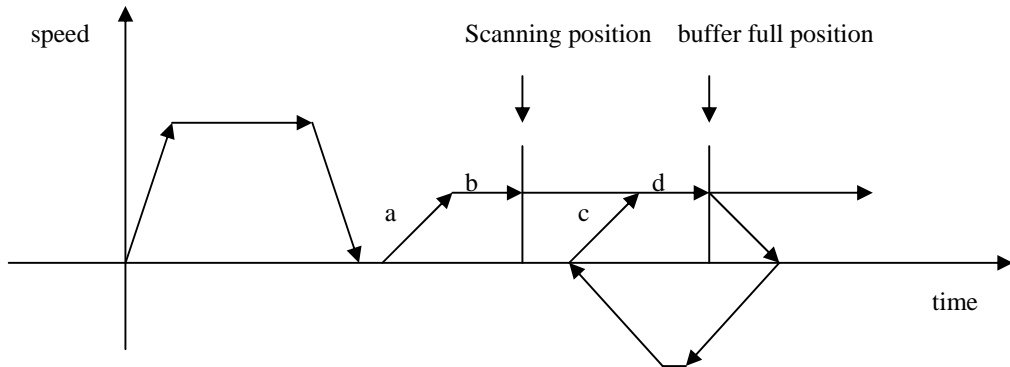

(2). One table moving :

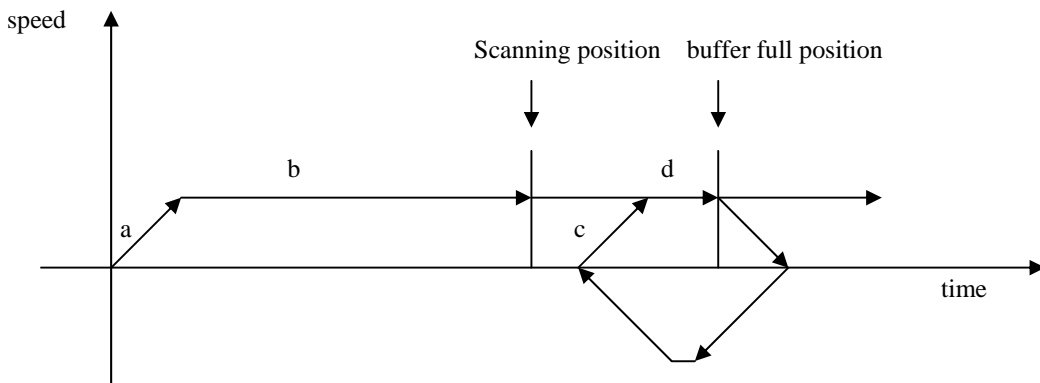

$$\{a+(b-1)\} \text{ mode LPERIOD} = Z2MOD$$

$$\{c+(d-1)\} \text{ mode LPERIOD} = Z1MOD$$

note: If MCNTSET[1:0]=01 or 10 or 11, then (each step curve value + 1)/VCNT.

VCNT= system clocks per pixel / (MCNTSET+1).

69. Reg : 66H (Read/Write)

Default : 00H

PHFREQ[7:0]: to set PWM frequency for motor phase of uni-polar.

Frequency : (24MHz)/[(PHFREQ+1)*4

70. Reg : 67H (Read/Write)

Default : 7FH

B7~6:STEPSEL[1:0] : for table one or two scanning move step type selection.

(1).bi-polar :

a.00: full step (for 1939,1940,2916,6219 or 3966).

b.01: half step (for 1939,1940,2916,6219 or 3966).

c.10: quarter step (for 2916 or 6219).

d.11: reserved.

(2).uni-polar :

a.00: two-phase-on full step.

b.01: half step.

c.10: reserved.

d.11: single-phase-on full step.

B5~0:MTRPWM[5:0] : to set PWM duty cycle for table one motor phase of uni-polar.

MTRPWM = 0 1/64 duty

= 1 2/64 duty

= 2 3/64 duty

.....

= 63 64/64 duty

Note: If PHFREQ < 0FH, then PWM setting must < (PHFREQ+1)*4

71. Reg : 68H (Read/Write)

Default : 7FH

FSTPSEL[1:0] : for table two fast moving step type selection.

(1).bi-polar :

a.00: full step (for 1939,1940,2916,6219 or 3966).

b.01: half step (for 1939,1940,2916,6219 or 3966).

c.10: quarter step (for 2916 or 6219).

d.11: reserved.

(2).uni-polar :

a.00: two-phase-on full step.

b.01: half step.

c.10: reserved.

d.11: single-phase-on full step.

FASTPWM[5:0] : to set PWM duty cycle for table two motor phase of uni-polar.

FASTPWM =0 1/64 duty

=1 2/64 duty

=2 3/64 duty

.....

=63 64/64 duty

Note: If PHFREQ < 0FH, then PWM setting must < (PHFREQ+1)*4

72. Reg : 69H (Read/Write)

Default : 00H

FSHDEC[7:0]: Set scan-finish deceleration slop steps(table three slope).

Note: can not be programmed to logic zero.

73. Reg : 6AH (Read/Write)

Default : 00H

FMOVNO[7:0]: Set fast moving slop steps(table four slope).
 Note: can not be programmed to logic zero.

(1). Two table moving :

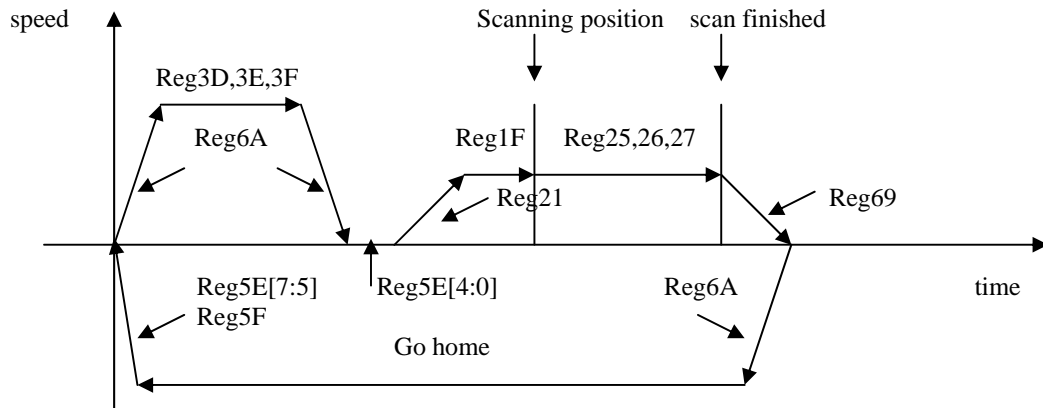

(2). One table moving :

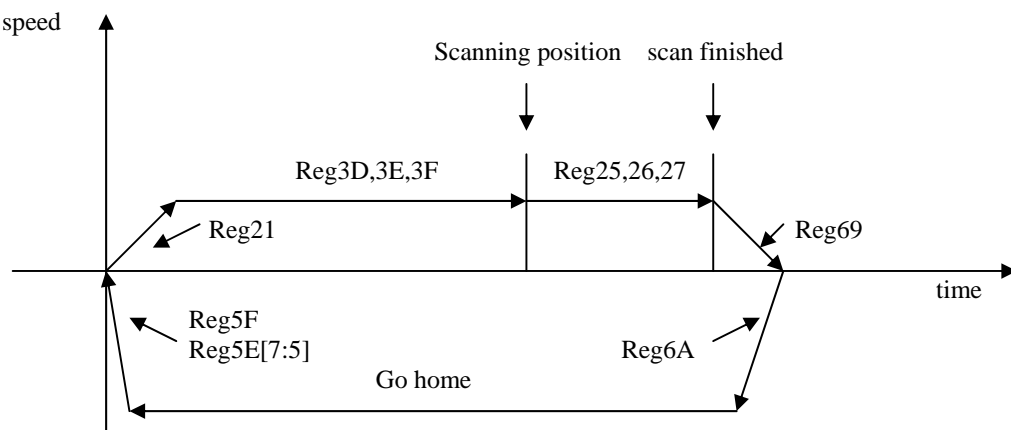

74. Reg :6BH (Read/Write)

Default : 00H

B7 : MULTFILM : to control motor phase idle to meet multi-film scan.

B6 : GPOM13 : set : output MOTORTGO.

: reset : output GPO13.

B5~4:GPOM12~11 : to select GPIO12~11 as Bi-polar motor driver V-ref input voltage in order to control drive current.

Note : GPIO12: 1. Pull up by resistor to indicate that ASIC turn on lamp power whenever power on initial.

2. Pull down by resistor to indicate that ASIC turn off lamp power whenever power on initial.

3. This pin can control bi-polar motor driver 1939,1940,2916,6219 or 3955 Vref in order to control I_{max}.current.

GPIO11: This pin can control bi-polar motor driver 1939,1940,2916,6219 or 3955 Vref in order to Control I_{max}. current.

B3 : Reserved.

B2 : Reserved.

B1~0:GPO18~17 : output GPO18,GPO17 ports.

75. Reg :6CH,6DH (Read/Write)

Default : 00H,00H

GPIO[16:1] : GPIO16~1 outputs ports

76. Reg :6EH,6FH (Read/Write)

Default : 00H,00H

GPOE[16:1] : GPO16~1 ports output enable set.

Set '1' : output.

Reset '0' : input.

77. Reg : 70H,71H (Read/Write)

Default:15H,17H

RSH[4:0] : set CCD RS rising edge position.

RSL[4:0] : set CCD RS falling edge position.

(1). Color, fine gray or fine line-art : 12 phase/pixel

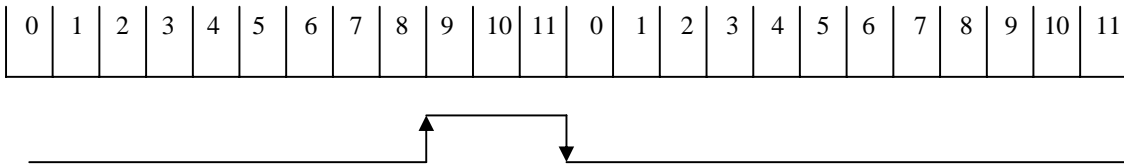

CCD RS : RSH=08H RSL=0BH

(2).Fast gray or fast line-art : 6 phase/pixel

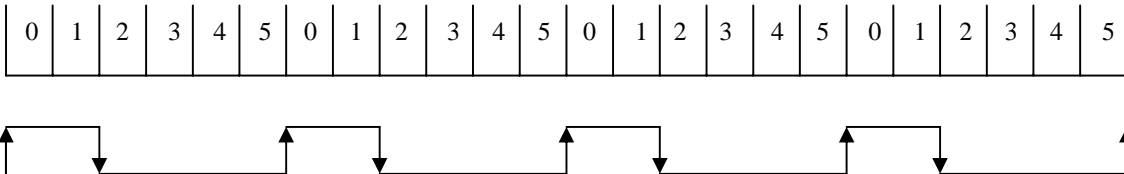

CCD RS : RSH=05H RSL=01H

78. Reg : 72H,73H (Read/Write)

Default:15H,17H

CPH[4:0] : set CCD CP rising edge position.

CPL[4:0] : set CCD CP falling edge position.

(1). Color, fine gray or fine line-art : 12 phase/pixel

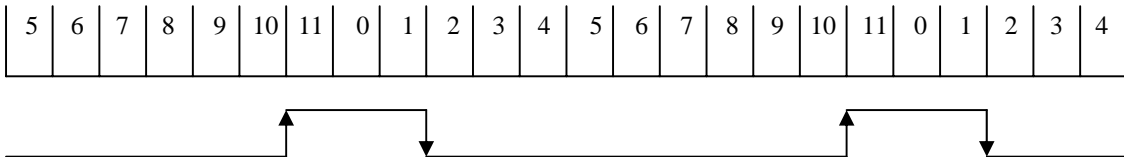

CCD CP : CPH=0AH CPL=01H

(2).Fast gray or fast line-art : 6 phase/pixel

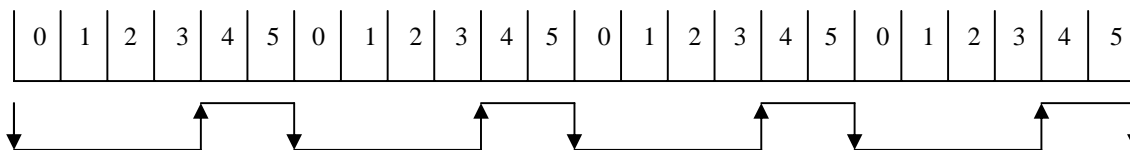

CCD CP : CPH=03H CPL=05H

79. Reg : 74H,75H,76H (Read/Write)

Default : 00H,00H,00H

CK1MAP[17:0] : CCD clock 1 bits mapping function.

80. Reg : 77H,78H,79H (Read/Write)

Default : 00H,00H,00H

CK3MAP[17:0] : CCD clock 3 bits mapping function.

81. Reg : 7AH,7BH,7CH (Read/Write)

Default : 00H,00H,00H

CK4MAP[17:0] : CCD clock 4 bits mapping function.

82. Reg : 7DH (Read/Write)

Default : 00H

- B7: CK1NEG : set: CCD clock1,clock2 output locate at negative edge position of system clock.
: reset : CCD clock1,clock2 output locate at positive edge position of system clock.
- B6: CK3NEG : set : CCD clock3 output locate at negative edge position of system clock.
: reset : CCD clock3 output locate at positive edge position of system clock.
- B5: CK4NEG : set : CCD clock4 output locate at negative edge position of system clock.
: reset : CCD clock4 output locate at positive edge position of system clock.
- B4: RSNEG : set : CCD RS output locate at negative edge position of system clock.
: reset : CCD RS output locate at positive edge position of system clock.
- B3: CPNEG : to set CCD CP output locate at negative edge position of system clock.
: reset : CCD CP output locate at positive edge position of system clock.
- B2: BSMPNEG : set : AFE video sample output locate at negative edge position of system clock.
: reset : AFE video sample output locate at positive edge position of system clock.
- B1: VSMPNEG : set : AFE dark sample output locate at negative edge position of system clock.
: reset : AFE dark sample output locate at positive edge position of system clock.
- B0: DLYSET : set : to enable VSMP and BSMP to delay output by 8.33ns unit
: reset : disable this function.

83. Reg : 7EH (Read/Write)

Default : 00H

- B5 :GPOLED18 : set : GPIO 18 as LED outout.
: reset : GPIO18 as general I/O.
- B4 :GPOLED17 : set : GPIO 17 as LED outout.
: reset : GPIO17 as general I/O.
- B3 :GPOLED16 : set : GPIO 16 as LED outout.
: reset : GPIO16 as general I/O.
- B2 :GPOLED15 : set : GPIO 15 as LED outout.
: reset : GPIO15 as general I/O.
- B1 :GPOLED14 : set : GPIO 14 as LED outout.
: reset : GPIO14 as general I/O.
- B0 :GPOLED13 : set : GPIO 13 as LED outout.
: reset : GPIO13 as general I/O.

84. Reg : 7FH (Read/Write)

Default : 00H

- B7~6 : [1:0]BSMPDLY : to set BSMP output delay.
 2'b00: no delay.
 2'b01:delay 8.33ns
 2'b10:delay 16.67ns
 2'b11:delay 25ns.
- B5~4 : [1:0]VSMPDLY : to set VSMP output delay.
 2'b00: no delay.
 2'b01:delay 8.33ns
 2'b10:delay 16.67ns
 2'b11:delay 25ns.
- B3~0 : [3:0]LEDCNT : to set LED blinking speed.
 The unit is 100ms.

85. Reg : 80H (Read/Write)

Default:00H

- B7~6: VRHOME[1:0] : to set the Vref. of the motor driver IC for go-home moving.
 B5~4: VRMOVE[1:0] : to set the Vref. of the motor driver IC for fast forward moving.
 B3~2: VRBACK[1:0] : to set the Vref. of the motor driver IC for backward moving.
 B1~0: VRSCAN[1:0] : to set the Vref. of the motor driver IC for scan forward moving.

86. Reg : 81H,82H (Read/Write)

Default:00H,00H

- B8~0: ROFFSET[8:0] : to set R Channel Offset of the AFE for CIS color scan.

87. Reg : 83H,84H (Read/Write)

Default:00H,00H

- B8~0: GOFFSET[8:0] : to set G Channel Offset of the AFE for CIS color scan.

88. Reg : 85H,86H (Read/Write)

Default:00H,00H

- B8~0: BOFFSET[8:0] : to set B Channel Offset of the AFE for CIS color scan.

89. Reg : 87H (Read/Write)

Default:00H

- B7 : Reserved.
- B6 : YENB : set: to enable PH_Y output of the YBIT.
 : reset: to disable PH_Y output of the YBIT.
- B5 : YBIT : to output PH_Y status.
- B4 : ACYCNRLC : set: to generate RLC/ACYC pulse to trigger WM8199 auto-cycling for
 Line-by-line color scanning.
 : reset: to disable this function.
- B3 : ENOFFSET : set: to select automatic offset configuration for CIS scanning.
 : reset: to disable this function.
- B2 : LEDADD : set: enable true gray by controlling CIS RGB LED array.
 : reset: normal gray by controlling CIS single color LED array.
- B1 : CK4ADC : set: to select ADCCLK output by CK4MAP setting.
 : reset: to select ADCCLK output by default.
- B0 : AUTOCONF : set: to enable automatic channel,offset configuration or or RLC/ACYC pulsing
 for CIS color scan.
 : reset: to disable these function.

Note: If YBIT=1,then YENB=1 PH_Y=1;YENB=0 PH_Y=0.

If YBIT=0,then YENB=1 PH_Y=0;YENB=0 PH_Y=1.

90. Shading mapping(Chunky for single bank)

Attribute	Resolution	Address[19:0]
Shading Mapping	600dpi (DPIHW=00)	00000H~07FFFH SIZE : 32k
	1200dpi (DPIHW=01)	00000H~0FFFFH SIZE : 64k
	2400dpi (DPIHW=10)	00000H~1FFFFH SIZE : 128k

91. Shading mapping(Planer)

Attribute	Resolution		Address[19:0]
Shading Mapping	600dpi (DPIHW=00)	RED CHANNEL	00000H~029FFH
		GREEN CHANNEL	02A00H~053FFH
		BLUE CHANNEL	05400H~07DFFH
	1200dpi (DPIHW=01)	RED CHANNEL	00000H~054FFH
		GREEN CHANNEL	05500H~0A9FFH
		BLUE CHANNEL	0AA00H~0FEFFH
	2400dpi (DPIHW=10)	RED CHANNEL	00000H~0A7FFH
		GREEN CHANNEL	0A800H~14FFFH
		BLUE CHANNEL	15000H~1F7FFH

92. Slope Curve Table Mapping :

Attribute	Resolution	Table no.	Address[19:0]
Slope Curve Table	600DPI (DPIHW=00)	TABLE 1	08000 ~ 081FF
		TABLE 2	08200 ~ 083FF
		TABLE 3	08400 ~ 085FF
		TABLE 4	08600 ~ 087FF
		TABLE 5	08800 ~ 089FF
	1200DPI (DPIHW=01)	TABLE 1	10000 ~ 101FF
		TABLE 2	10200 ~ 103FF
		TABLE 3	10400 ~ 105FF
		TABLE 4	10600 ~ 107FF
		TABLE 5	10800 ~ 109FF
	2400DPI (DPIHW=10)	TABLE 1	20000 ~ 201FF
		TABLE 2	20200 ~ 203FF
		TABLE 3	20400 ~ 205FF
		TABLE 4	20600 ~ 207FF
		TABLE 5	20800 ~ 209FF

93. Image Buffer Mapping :

DRAM SIZE	Resolution	Address[19:0]
DRAM/SRAM 4M BITS X 1	600DPI (DPIHW=00)	09000H~3FFFFH
	1200DPI (DPIHW=01)	11000H~3FFFFH
	2400DPI (DPIHW=10)	21000H~3FFFFH
DRAM 4M BITS X 2 or 8M BITS SRAM	600DPI (DPIHW=00)	09000H~7FFFFH
	1200DPI (DPIHW=01)	11000H~7FFFFH
	2400DPI (DPIHW=10)	21000H~7FFFFH
DRAM 16M BITS	600DPI (DPIHW=00)	09000H~FFFFFFH
	1200DPI (DPIHW=01)	11000H~FFFFFFH
	2400DPI (DPIHW=10)	21000H~FFFFFFH

8 Package – 128QFP :

SYMBOLS	MIN(mm)	NOM(mm)	MAX(mm)
A1	0.25	0.35	0.45
A2	2.57	2.72	2.87
b	0.10	0.20	0.30
C	0.10	0.15	0.20
D	13.90	14.00	14.10
E	19.90	20.00	20.10
e	-	0.50	-
Hd	17.00	17.20	17.40
He	23.00	23.20	23.40
L	0.65	0.80	0.95
L1	-	1.60	-
Y	-	-	0.08
Θ	0	-	12

