

**FEATURES**

- complete linear system
- current mode class H output stage
- current drive power amp
- low distortion / low noise
- low amplifier current 190  $\mu$ A typical

**STANDARD PACKAGING**

- Hybrid Typical Dimensions  
0.225in x 0.130in x 0.110in  
(5.72mm x 3.31mm x 2.79mm)

**DESCRIPTION**

The GS3013 is a linear hybrid containing three amplifier stages.

This product incorporates a current mode class H power amplifier.

By adapting the bias of the output stage to the requirements of the signal being processed, significant current savings can be realised compared to traditional class A amplifiers.

The adaptive action does not compromise the characteristics of a current drive output stage.

In addition to the output stage, two additional stages of preamplification are provided to allow filtering and gain adjustment to be easily accomplished.

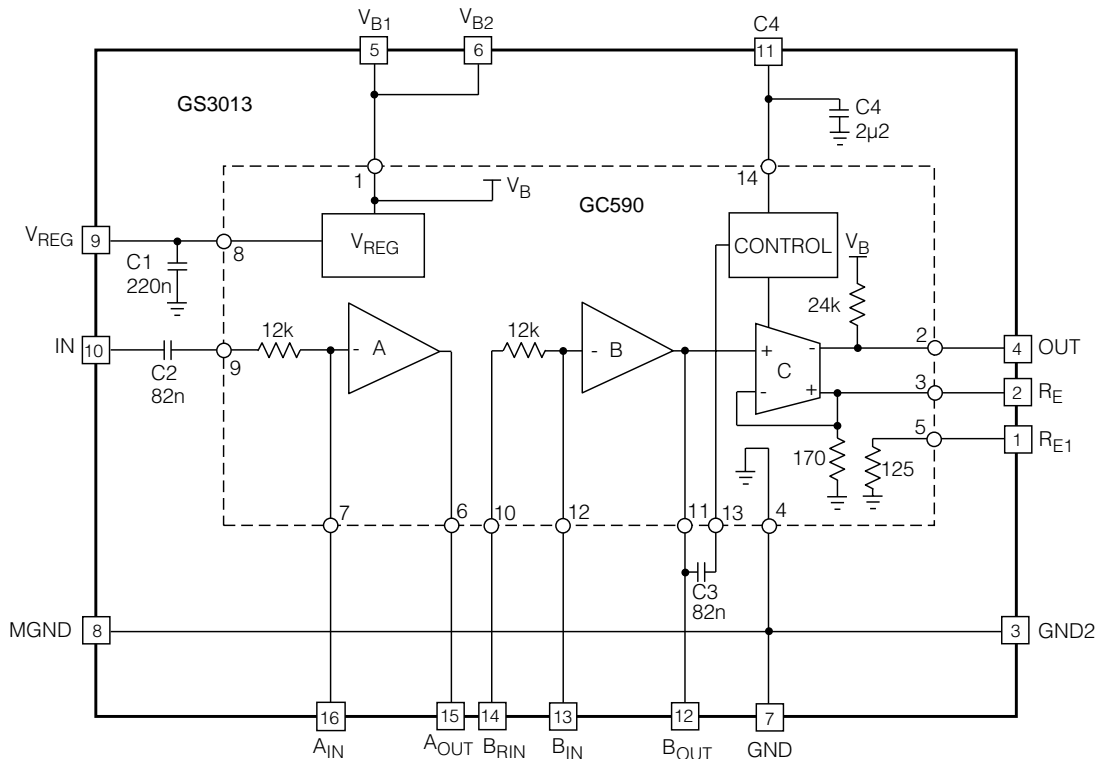

All resistors in ohms, all capacitors in farads unless otherwise stated.

**FUNCTIONAL BLOCK DIAGRAM**

## ABSOLUTE MAXIMUM RATINGS

PARAMETER	VALUE / UNITS
Supply Voltage	5 VDC
Power Dissipation	25 mW
Operating Temperature Range	-10° C to 40° C
Storage Temperature Range	-20° C to 70° C

**CAUTION**  
CLASS 1 ESD SENSITIVITY



## PAD CONNECTION

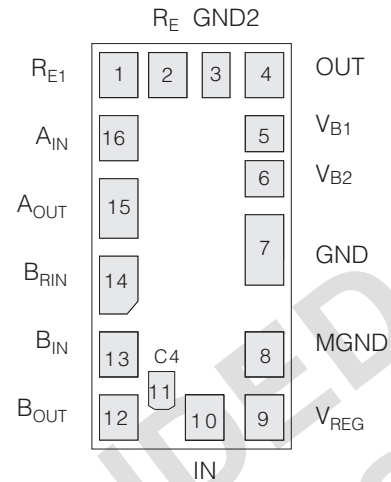

## ELECTRICAL CHARACTERISTICS

Conditions: Frequency = 1 kHz, Temperature 25 °C, Voltage Supply = 1.3 VDC

PARAMETER	SYMBOL	CONDITIONS	MIN	TYP	MAX	UNITS
<b>OVERALL</b>						
Amplifier Current	$I_{AMP}$		80	190	300	$\mu A$
Minimum Operating Voltage	$V_B$		-	-	1.1	V
Overall Gain	$A_V$		51	54	57	dB
Distortion	THD	$V_{IN} = -40$ dBV $R_{TRIM} = R_{VC} = 10$ k $\Omega$	-	0.2	1	%
Input Referred Noise	IRN	A Weighted Filter	-	-	2.5	$\mu V_{RMS}$
<b>VOLTAGE REGULATOR</b>						
Regulator Voltage	$V_{REG}$	$I_{LOAD} = 30$ $\mu A$	870	920	970	mVDC
Output Noise		A Weighted	-	2.9	-	$\mu V_{RMS}$
<b>STAGE A AND STAGE B</b>						
Input Bias Current	$I_{BIAS}$		-25	0	25	nA
DC Voltage Gain Stage A	$A_{OL-A}$		-	52	-	dB
DC Voltage Gain Stage B	$A_{OL-B}$		-	42	-	dB
Current Source Capabilities	$I_{SOURCE}$		15	30	-	$\mu A$
Output Voltage Swing - Low	$V_{SINK}$		260	315	-	mV
<b>STAGE C AND CONTROL CIRCUIT</b>						
Maximum Current Sinking	$I_{SINK}$	$R_E$ grounded, $V_{P4} = 1.3$ V	3	6	-	mA
Output Impedance	$R_{OUT}$		-	24	-	k $\Omega$
Minimum Emitter Voltage	$V_{RE-MIN}$		2	5	9	mV
Maximum Emitter Voltage	$V_{RE-MAX}$		62	66	74	mV
Minimum Transducer Current	$I_{T-MIN}$	$R_E, R_{E1}$ shorted	26	71	126	$\mu A$
Maximum Transducer Current	$I_{T-MAX}$	$R_E, R_{E1}$ shorted	750	930	1100	$\mu A$
Maximum/Minimum Transducer Current Ratio	$I_{RANGE}$		16	20	28	dB
Dynamic Headroom	Headroom	Note 1	14	17	22	dB
Time Constant	$T_C$		-	100	-	mS

All parameters and switches remain as shown in the Test Circuit unless otherwise stated in CONDITIONS column.

**Notes:** 1. Headroom =  $20 \text{ Log} (V_{RE-DC} / V_{RE-ACRMS})$  [ $V_{IN} = -70$  dBV]



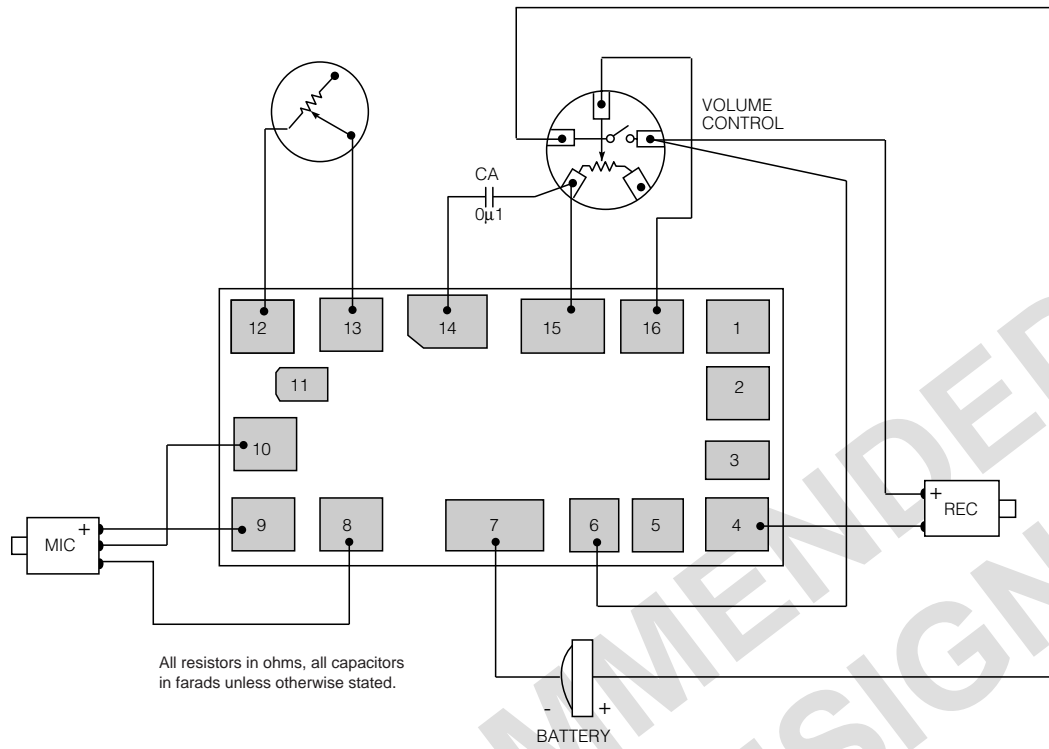

Fig. 3 Typical Assembly Diagram

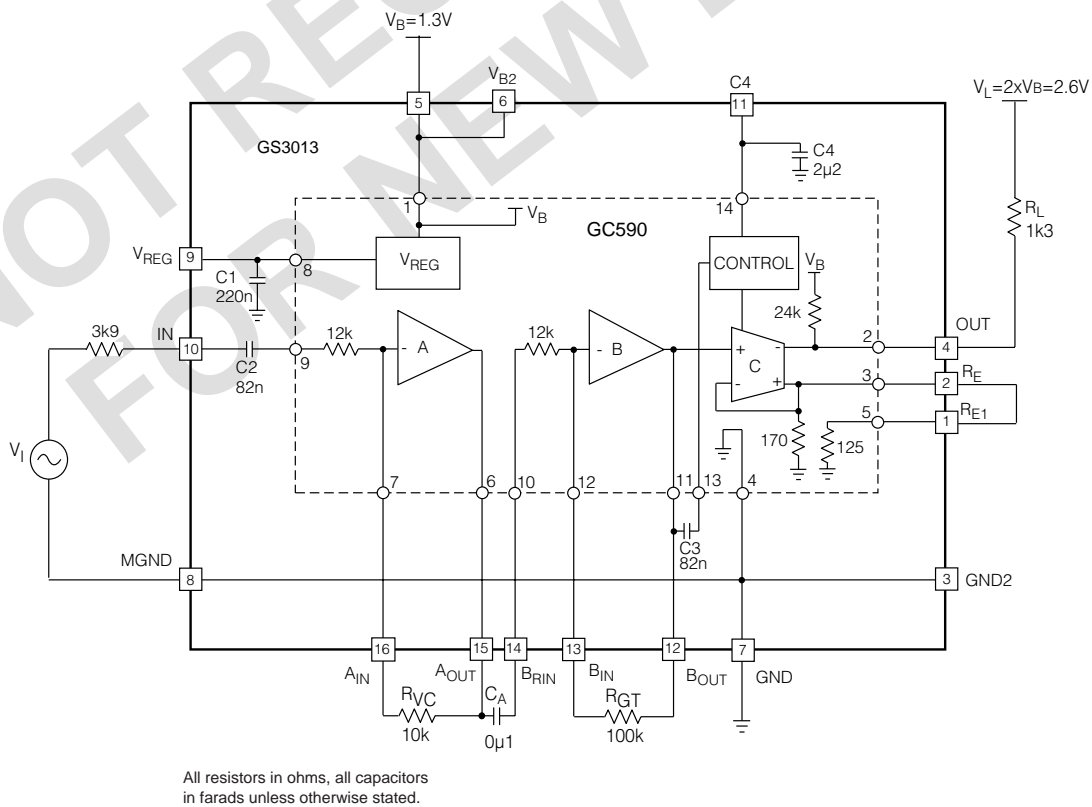

Fig. 4 Characterization Circuit

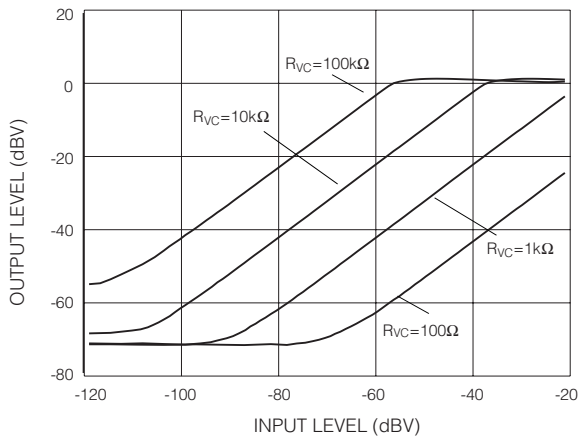

Fig. 5 Input vs Output Transfer Function for the Different Values of the  $R_{VC}$  Resistor

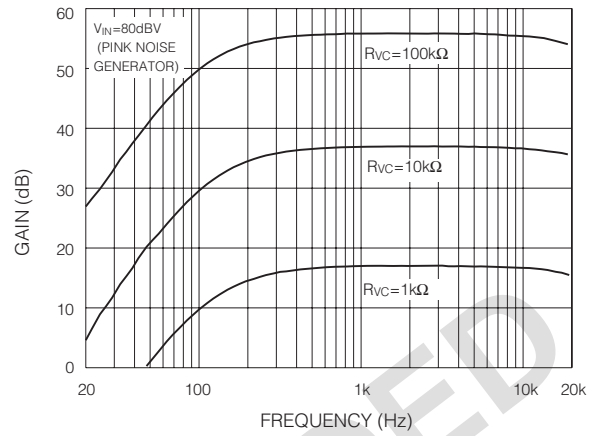

Fig. 6 Frequency Response for Different  $R_{VC}$  Values

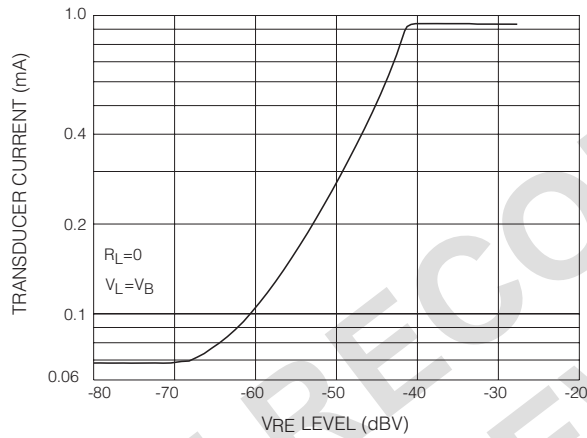

Fig. 7 Transducer Current Characteristics

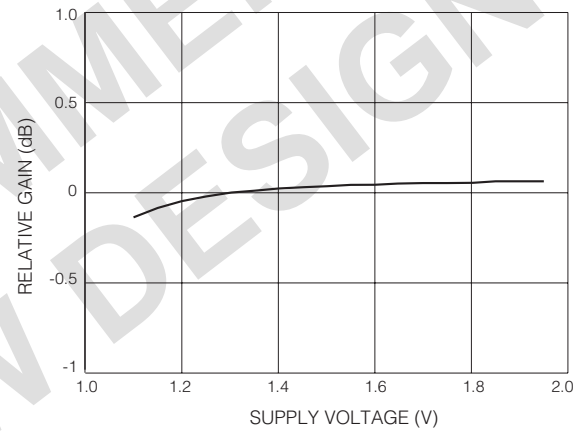

Fig. 8 System Gain vs Supply

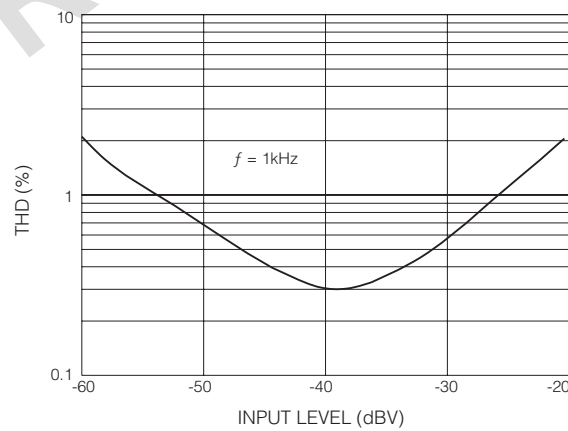

Fig. 9 THD & Noise vs Input Level

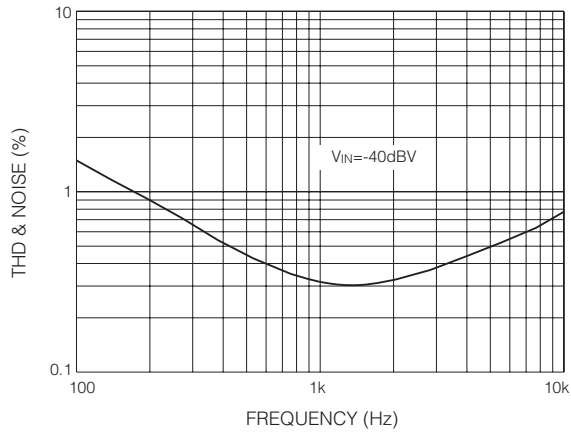

Fig. 10 THD & Noise vs Frequency

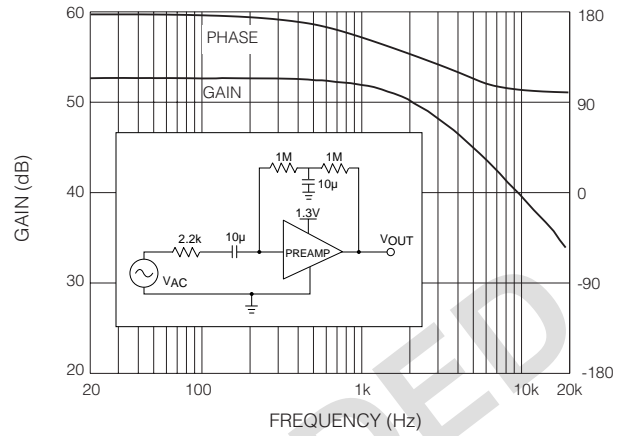

Fig. 11 Stage A Open Loop Gain & Phase vs Frequency

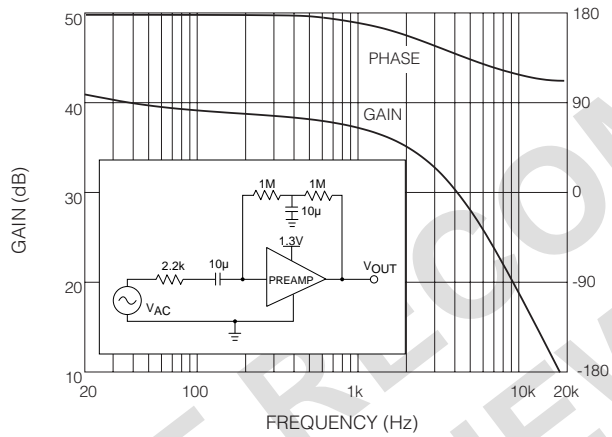

Fig. 12 Stage B Open Loop Gain & Phase vs Frequency

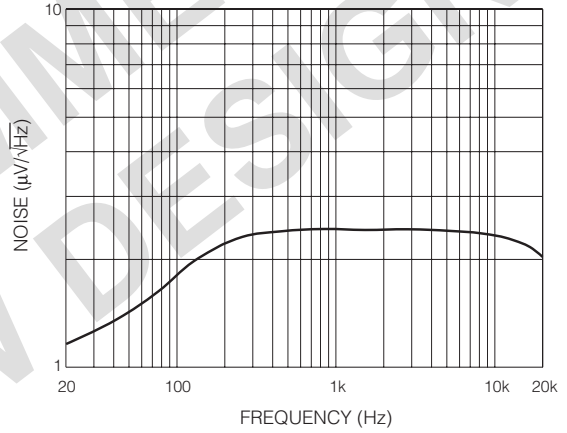

Fig. 13 Output Noise vs Frequency

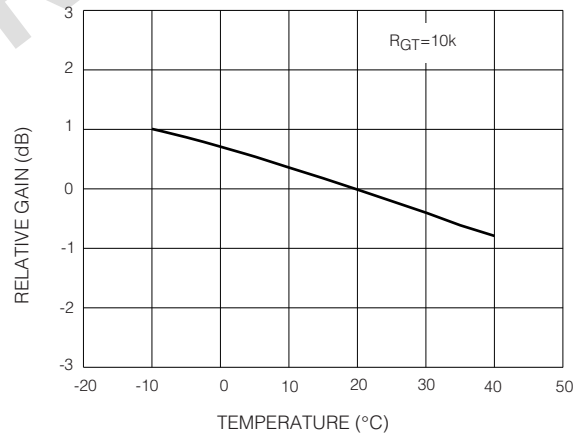
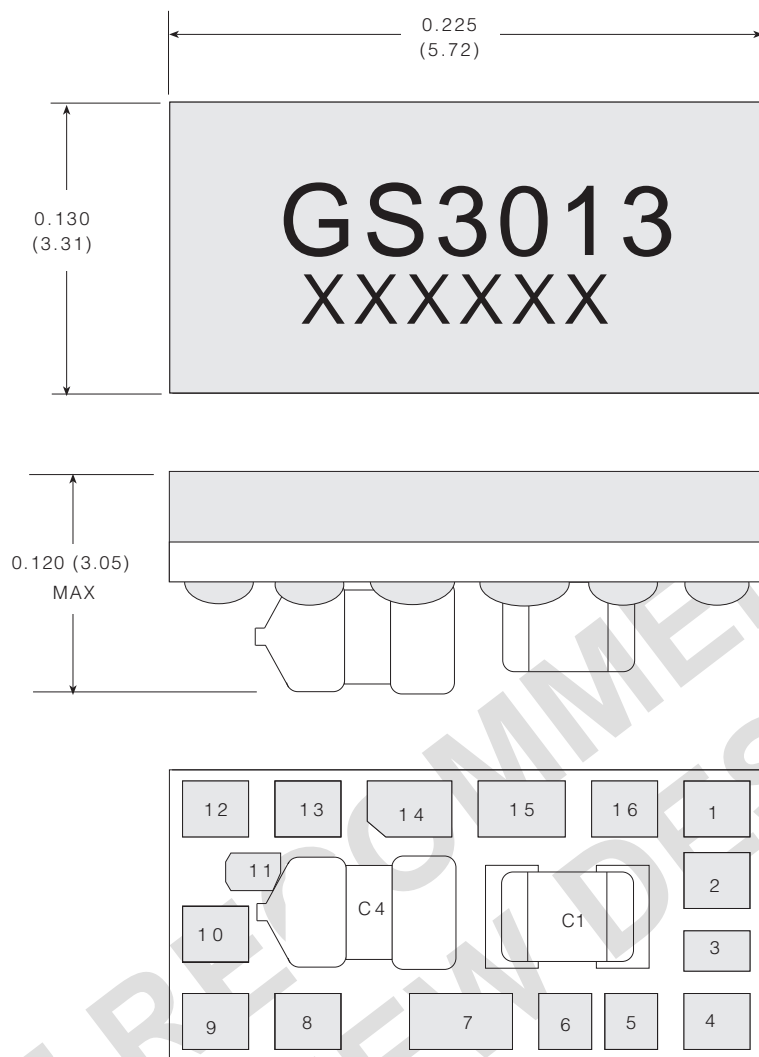

Fig. 14 Relative Gain vs Temperature



Dimension units are in inches.  
 Dimensions in parenthesis are in millimetres converted from inches and include minor rounding errors.  
 1.0000 inches = 25.400 mm.  
 Smallest pad no.3 0.025 x 0.018 (0.63 x 0.46).  
 Largest pad no.7 0.039 x 0.025 (0.99 x 0.64).  
 Dimension tolerances:  $\pm 0.005$  (+0.13) unless otherwise stated.  
 Pad numbers and capacitor numbers for illustration only.  
 XXXXXX - work order number.  
 This hybrid is designed for point to point manual soldering.

Fig. 8 Hybrid Layout & Dimensions

**DOCUMENT IDENTIFICATION: DATA SHEET**  
 The product is in production. Gennum reserves the right to make changes at any time to improve reliability, function or design, in order to provide the best product possible.

**REVISION NOTES:**  
 Updated to Data sheet