

FP-BGA
Commercial Temp
Industrial Temp

256K x 16

4Mb Asynchronous SRAM

7, 8, 10, 12 ns
3.3 V V_{DD}
Center V_{DD} and V_{SS}

Features

- Fast access time: 7, 8, 10, 12 ns
- CMOS low power operation: 150/130/105/95 mA at minimum cycle time
- Single 3.3 V power supply
- All inputs and outputs are TTL-compatible
- Byte control
- Fully static operation
- Industrial Temperature Option: -40° to 85°C
- Package:
 - X: 6 mm x 10 mm Fine Pitch Ball Grid Array package

Description

The GS74117A is a high speed CMOS Static RAM organized as 262,144 words by 16 bits. Static design eliminates the need for external clocks or timing strobes. The GS operates on a single 3.3 V power supply and all inputs and outputs are TTL-compatible. The GS74117A is available in a 6 x 10 mm Fine Pitch BGA package.

Pin Descriptions

Symbol	Description
A ₀ –A ₁₇	Address input
DQ ₁ –DQ ₁₆	Data input/output
$\overline{\text{CE}}$	Chip enable input
$\overline{\text{LB}}$	Lower byte enable input (DQ ₁ to DQ ₈)
$\overline{\text{UB}}$	Upper byte enable input (DQ ₉ to DQ ₁₆)
$\overline{\text{WE}}$	Write enable input
$\overline{\text{OE}}$	Output enable input
V_{DD}	+3.3 V power supply
V_{SS}	Ground
NC	No connect

Fine Pitch BGA 256K x 16 Bump Configuration

	1	2	3	4	5	6
A	$\overline{\text{LB}}$	$\overline{\text{OE}}$	A ₀	A ₁	A ₂	NC
B	DQ ₁	$\overline{\text{UB}}$	A ₃	A ₄	$\overline{\text{CE}}$	DQ ₁₆
C	DQ ₃	DQ ₂	A ₅	A ₆	DQ ₁₅	DQ ₁₄
D	VSS	DQ ₄	A ₁₇	A ₇	DQ ₁₃	VDD
E	VDD	DQ ₅	NC	A ₁₆	DQ ₁₂	VSS
F	DQ ₆	DQ ₇	A ₈	A ₉	DQ ₁₀	DQ ₁₁
G	DQ ₈	NC	A ₁₀	A ₁₁	$\overline{\text{WE}}$	DQ ₉
H	NC	A ₁₂	A ₁₃	A ₁₄	A ₁₅	NC

Package X
6 x 10 mm Bump Pitch
Top View

Block Diagram

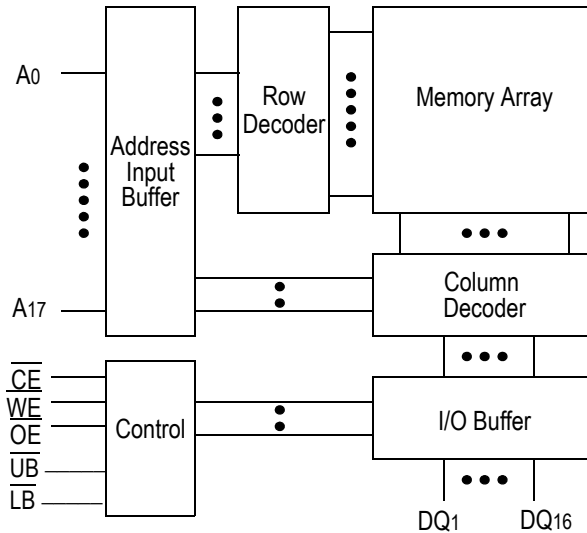

Truth Table

$\overline{\text{CE}}$	$\overline{\text{OE}}$	$\overline{\text{WE}}$	$\overline{\text{LB}}$	$\overline{\text{UB}}$	DQ1 to DQ8	DQ9 to DQ16	VDD Current
H	X	X	X	X	Not Selected	Not Selected	ISB1, ISB2
L	L	H	L	L	Read	Read	I _{DD}
			L	H	Read	High Z	
			H	L	High Z	Read	
L	X	L	L	L	Write	Write	
			L	H	Write	Not Write, High Z	
			H	L	Not Write, High Z	Write	
L	H	H	X	X	High Z	High Z	
L	X	X	H	H	High Z	High Z	

Note: X: "H" or "L"

Absolute Maximum Ratings

Parameter	Symbol	Rating	Unit
Supply Voltage	V _{DD}	-0.5 to +4.6	V
Input Voltage	V _{IN}	-0.5 to V _{DD} +0.5 (≤ 4.6 V max.)	V
Output Voltage	V _{OUT}	-0.5 to V _{DD} +0.5 (≤ 4.6 V max.)	V
Allowable power dissipation	PD	0.7	W
Storage temperature	T _{STG}	-55 to 150	°C

Note:

Permanent device damage may occur if Absolute Maximum Ratings are exceeded. Functional operation shall be restricted to Recommended Operating Conditions. Exposure to higher than recommended voltages for extended periods of time could affect device reliability.

Recommended Operating Conditions

Parameter	Symbol	Min	Typ	Max	Unit
Supply Voltage for -7/-8/-10/-12	V _{DD}	3.0	3.3	3.6	V
Input High Voltage	V _{IH}	2.0	—	V _{DD} +0.3	V
Input Low Voltage	V _{IL}	-0.3	—	0.8	V
Ambient Temperature, Commercial Range	T _{Ac}	0	—	70	°C
Ambient Temperature, Industrial Range	T _{AI}	-40	—	85	°C

Notes:

1. Input overshoot voltage should be less than V_{DD} +2 V and not exceed 20 ns.
2. Input undershoot voltage should be greater than -2 V and not exceed 20 ns.

Capacitance

Parameter	Symbol	Test Condition	Max	Unit
Input Capacitance	C _{IN}	V _{IN} = 0 V	5	pF
Output Capacitance	C _{OUT}	V _{OUT} = 0 V	7	pF

Notes:

1. Tested at T_A = 25°C, f = 1 MHz
2. These parameters are sampled and are not 100% tested.

DC I/O Pin Characteristics

Parameter	Symbol	Test Conditions	Min	Max
Input Leakage Current	I _{IL}	V _{IN} = 0 to V _{DD}	-1 µA	1 µA
Output Leakage Current	I _{LO}	Output High Z V _{OUT} = 0 to V _{DD}	-1 µA	1 µA
Output High Voltage	V _{OH}	I _{OH} = -4 mA	2.4	—
Output Low Voltage	V _{OL}	I _{LO} = +4 mA	—	0.4 V

Power Supply Currents

Parameter	Symbol	Test Conditions	0 to 70°C				-40 to 85°C				Unit
			7 ns	8 ns	10 ns	12 ns	7 ns	8 ns	10 ns	12 ns	
Operating Supply Current	I _{DD}	$\overline{CE} \leq V_{IL}$ All other inputs $\geq V_{IH}$ or $\leq V_{IL}$ Min. cycle time I _{OUT} = 0 mA	150	130	105	90	160	140	115	100	mA
Standby Current	I _{SB1}	$\overline{CE} \geq V_{IH}$ All other inputs $\geq V_{IH}$ or $\leq V_{IL}$ Min. cycle time	28	30	25	22	38	40	35	32	mA
Standby Current	I _{SB2}	$\overline{CE} \geq V_{DD} - 0.2 V$ All other inputs $\geq V_{DD} - 0.2 V$ or $\leq 0.2 V$	10				20				mA

AC Test Conditions

Parameter	Conditions
Input high level	$V_{IH} = 2.4\text{ V}$
Input low level	$V_{IL} = 0.4\text{ V}$
Input rise time	$t_r = 1\text{ V/ns}$
Input fall time	$t_f = 1\text{ V/ns}$
Input reference level	1.4 V
Output reference level	1.4 V
Output load	Fig. 1 & 2

Note:

1. Include scope and jig capacitance.
2. Test conditions as specified with output loading as shown in **Fig. 1** unless otherwise noted.
3. Output load 2 for t_{LZ} , t_{HZ} , t_{OLZ} and t_{OHZ}

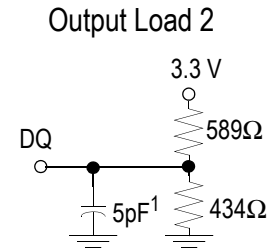
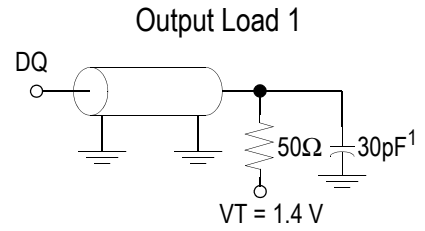

AC Characteristics
Read Cycle

Parameter	Symbol	-7		-8		-10		-12		Unit
		Min	Max	Min	Max	Min	Max	Min	Max	
Read cycle time	t _{RC}	7	—	8	—	10	—	12	—	ns
Address access time	t _{AA}	—	7	—	8	—	10	—	12	ns
Chip enable access time (\overline{CE})	t _{AC}	—	7	—	8	—	10	—	12	ns
Byte enable access time (\overline{UB} , \overline{LB})	t _{AB}	—	3	—	3.5	—	4	—	5	ns
Output enable to output valid (\overline{OE})	t _{OE}	—	3	—	3.5	—	4	—	5	ns
Output hold from address change	t _{OH}	3	—	3	—	3	—	3	—	ns
Chip enable to output in low Z (\overline{CE})	t _{LZ} *	3	—	3	—	3	—	3	—	ns
Output enable to output in low Z (\overline{OE})	t _{OLZ} *	0	—	0	—	0	—	0	—	ns
Byte enable to output in low Z (\overline{UB} , \overline{LB})	t _{BLZ} *	0	—	0	—	0	—	0	—	ns
Chip disable to output in High Z (\overline{CE})	t _{HZ} *	—	3.5	—	4	—	5	—	6	ns
Output disable to output in High Z (\overline{OE})	t _{OHZ} *	—	3	—	3.5	—	4	—	5	ns
Byte disable to output in High Z (\overline{UB} , \overline{LB})	t _{BHZ} *	—	3	—	3.5	—	4	—	5	ns

* These parameters are sampled and are not 100% tested.

Read Cycle 1: $\overline{CE} = \overline{OE} = V_{IL}$, $\overline{WE} = V_{IH}$, \overline{UB} and, or $\overline{LB} = V_{IL}$

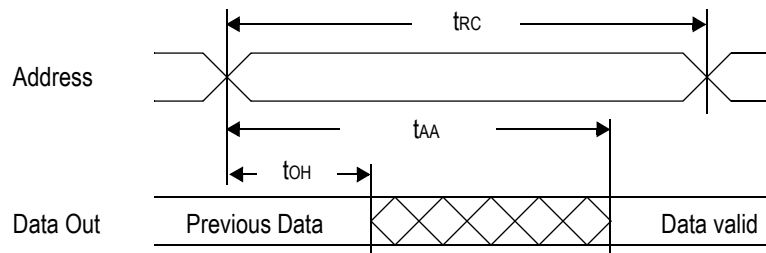

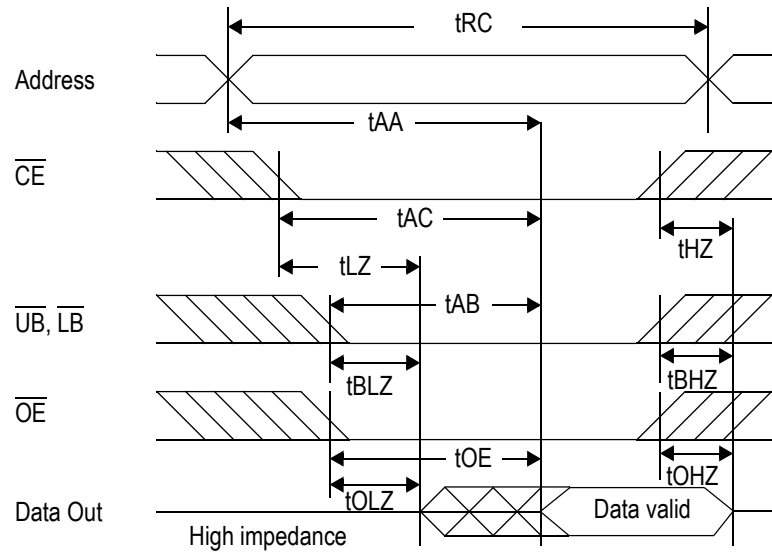
Read Cycle 2: $\overline{WE} = V_{IH}$

Write Cycle

Parameter	Symbol	-7		-8		-10		-12		Unit
		Min	Max	Min	Max	Min	Max	Min	Max	
Write cycle time	t_{WC}	7	—	8	—	10	—	12	—	ns
Address valid to end of write	t_{AW}	5	—	5.5	—	7	—	8	—	ns
Chip enable to end of write	t_{CW}	5	—	5.5	—	7	—	8	—	ns
Byte enable to end of write	t_{BW}	5	—	5.5	—	7	—	8	—	ns
Data set up time	t_{DW}	3.5	—	4	—	4.5	—	6	—	ns
Data hold time	t_{DH}	0	—	0	—	0	—	0	—	ns
Write pulse width	t_{WP}	5	—	5.5	—	7	—	8	—	ns
Address set up time	t_{AS}	0	—	0	—	0	—	0	—	ns
Write recovery time (\overline{WE})	t_{WR}	0	—	0	—	0	—	0	—	ns
Write recovery time (\overline{CE})	t_{WR1}	0	—	0	—	0	—	0	—	ns
Output Low Z from end of write	t_{WLZ}^*	3	—	3	—	3	—	3	—	ns
Write to output in High Z	t_{WHZ}^*	—	3	—	3.5	—	4	—	5	ns

* These parameters are sampled and are not 100% tested.

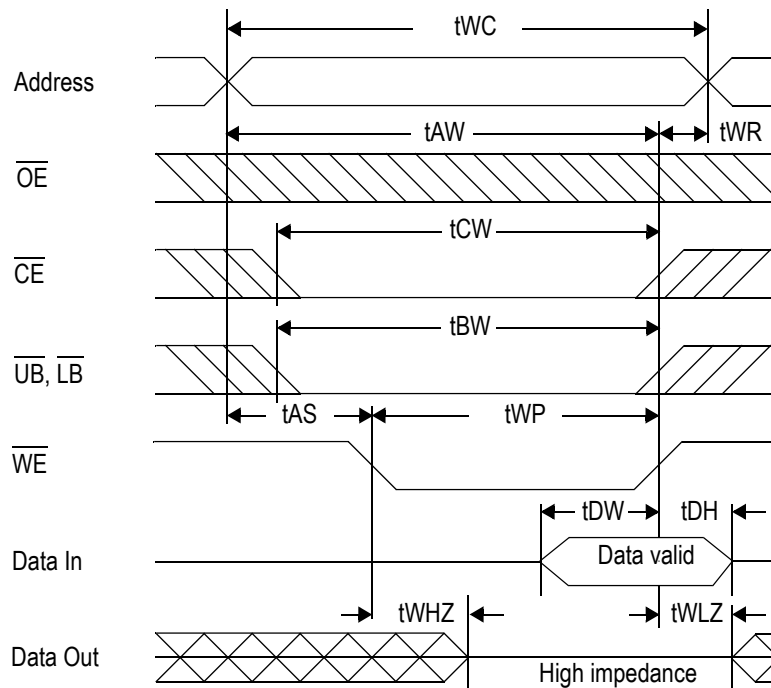
Write Cycle 1: \overline{WE} control



Write Cycle 2: \overline{CE} control

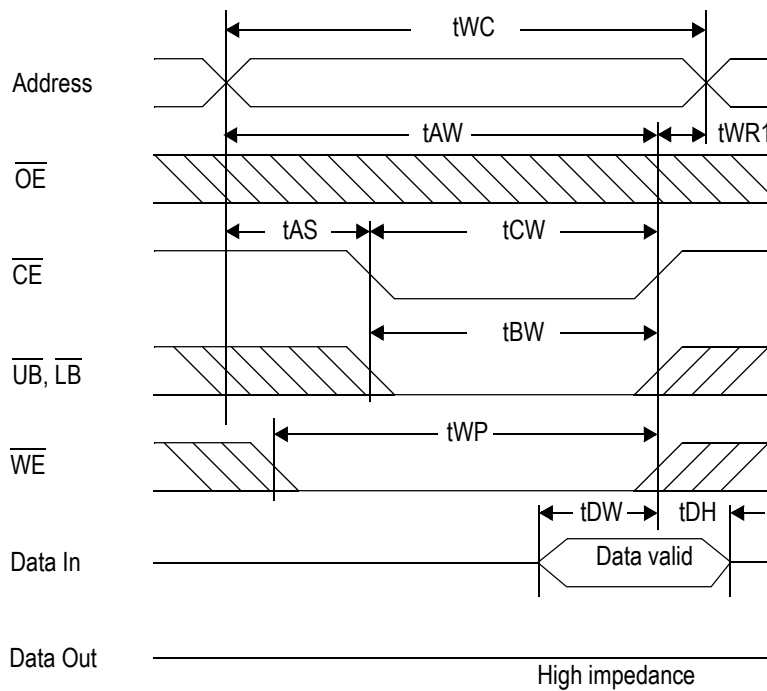

Write Cycle 3: \overline{UB} , \overline{LB} control

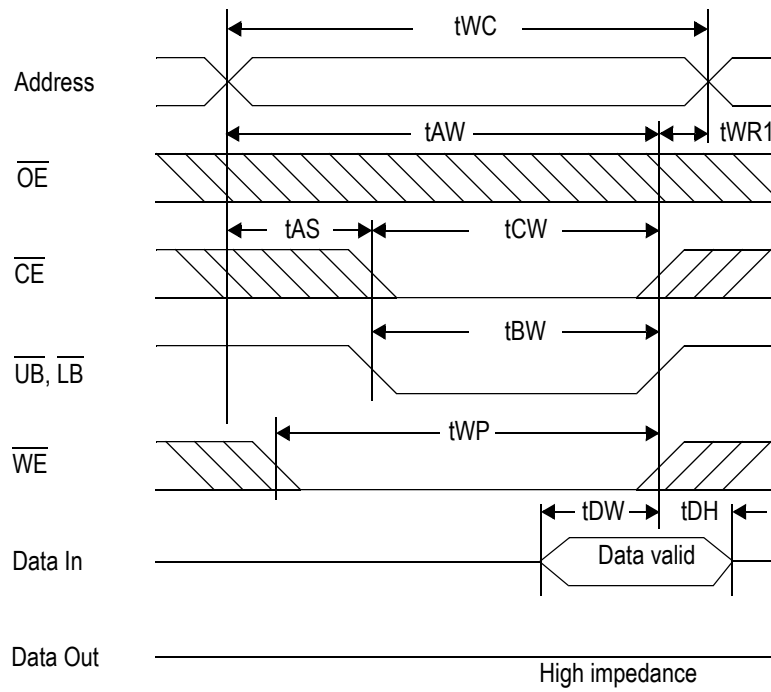

Package X—6 mm x 10 mm FP-BGA

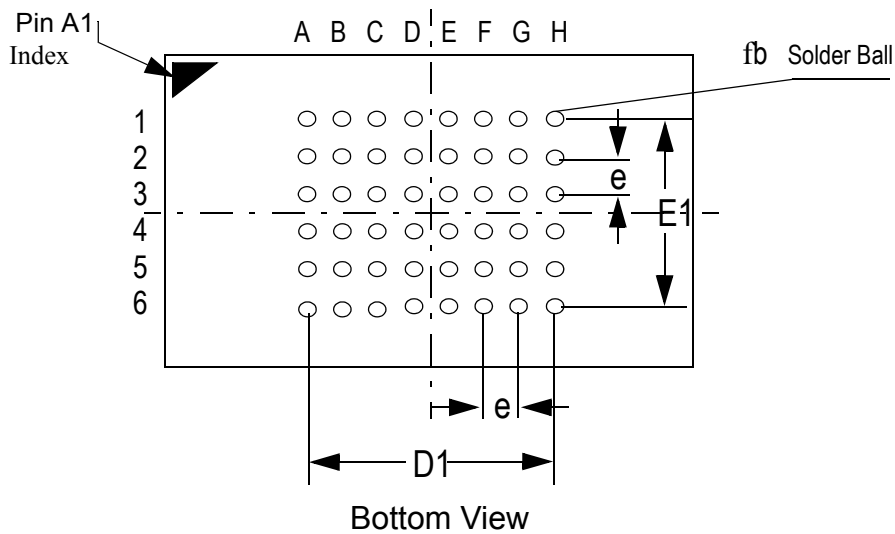
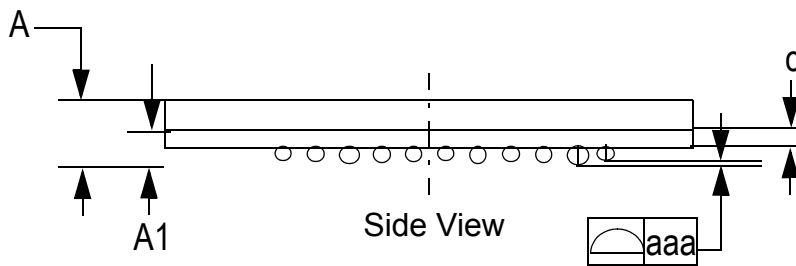
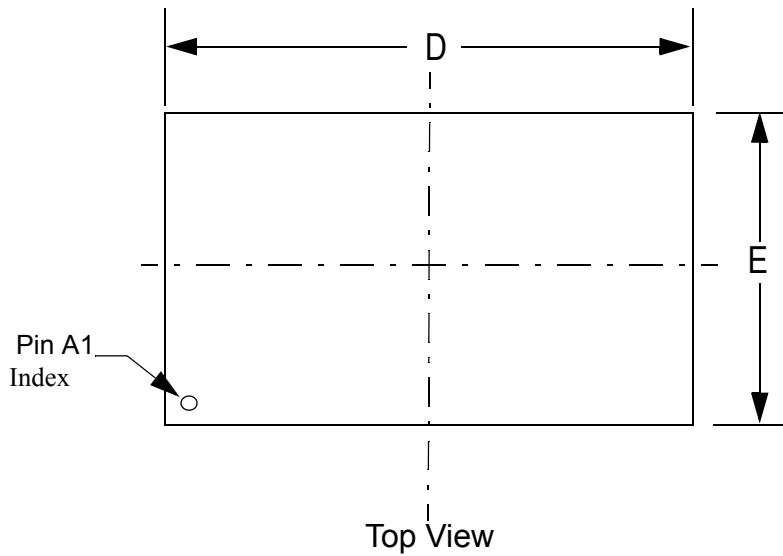

Symbol	Unit: mm
A	1.10±0.10
A1	0.20~0.30
fb	f0.30~0.40
c	0.36(TYP)
D	10.0±0.05
D1	5.25
E	6.0±0.05
E1	3.75
e	0.75(TYP)
aaa	0.10

Ordering Information

Part Number *	Package	Access Time	Temp. Range	Status
GS74117AX-7	6 mm x 10 mm BGA	7 ns	Commercial	
GS74117AX-8	6 mm x 10 mm BGA	8 ns	Commercial	
GS74117AX-10	6 mm x 10 mm BGA	10 ns	Commercial	
GS74117AX-12	6 mm x 10 mm BGA	12 ns	Commercial	
GS74117AX-7I	6 mm x 10 mm BGA	7 ns	Industrial	
GS74117AX-8I	6 mm x 10 mm BGA	8 ns	Industrial	
GS74117AX-10I	6 mm x 10 mm BGA	10 ns	Industrial	
GS74117AX-12I	6 mm x 10 mm BGA	12 ns	Industrial	

* Customers requiring delivery in Tape and Reel should add the character "T" to the end of the part number. For example:
GS74117AX-8T

4Mb Asynchronous Datasheet Revision History

Rev. Code: Old; New	Types of Changes Format or Content	Page #/Revisions/Reason
74117A_r1	Format/Content	• Creation of new datasheet
74117A_r1; 74117A_r1_01	Content	<ul style="list-style-type: none"> • Updated Recommended Operating Conditions table on page 3 • Updated Read Cycle and Write Cycle AC Characteristics tables
74117A_r1_01; 74117A_r1_02	Content	• Removed 6 ns speed bin from entire document