

High Sensitivity, Bialkali Photocathode 28mm (1-1/8 Inch) Diameter, 9-Stage, Side-On Type

FEATURES

● Spectral Response

R3788 185 to 750 nm

R4332 160 to 750 nm

● High Cathode Sensitivity

Luminous 120 μ A/lm Typ.

Radiant at 420nm 90mA/W Typ.

Quantum Efficiency at 210nm 40% Typ. (R4332)

● High Anode Sensitivity (at 1000V)

Luminous 1200A/lm Typ.

Radiant at 420nm 9.0×10^5 A/W Typ.



APPLICATIONS

- Fluorescence Spectrophotometers
- Emission Spectrophotometers
- Atomic Absorption Spectrophotometers

GENERAL

| Parameter | Description | Unit |
|------------------------------------|---------------------------------|------|
| Spectral Response | | |
| R3788 | 185 to 750 | nm |
| R4332 | 160 to 750 | nm |
| Wavelength of Maximum Response | 420 | nm |
| Photocathode | | |
| Material | Bialkali | — |
| Minimum Effective Area | 8 × 24 | mm |
| Window Material | | |
| R3788 | UV glass | — |
| R4332 | Fused silica | — |
| Dynode | | |
| Secondary Emitting Surface | Bialkali | — |
| Structure | Circular-cage | — |
| Number of Stages | 9 | — |
| Direct Interelectrode Capacitances | | |
| Anode to Last Dynode | 4 | pF |
| Anode to All Other Electrodes | 6 | pF |
| Base | 11-pin base JEDEC No. B11-88 | — |
| Weight | 45 | g |
| Suitable Socket | E678-11A (option) | — |
| Suitable Socket Assembly | E717-21(option) | — |

Figure 1: Typical Spectral Response

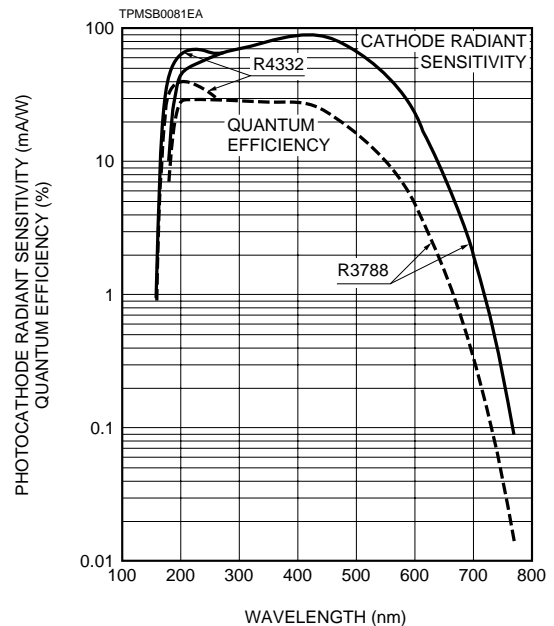

Subject to local technical requirements and regulations, availability of products included in this promotional material may vary. Please consult with our sales office.

Information furnished by HAMAMATSU is believed to be reliable. However, no responsibility is assumed for possible inaccuracies or omissions. Specifications are subject to change without notice. No patent rights are granted to any of the circuits described herein. © 1994 Hamamatsu Photonics K.K.

PHOTOMULTIPLIER TUBES R3788, R4332

MAXIMUM RATINGS (Absolute Maximum Values)

| Parameter | Value | Unit |
|------------------------------------|-------|------|
| Supply Voltage | | |
| Between Anode and Cathode | 1250 | Vdc |
| Between Anode and Last Dynode | 250 | Vdc |
| Average Anode Current ^A | 0.1 | mA |

CHARACTERISTICS (at 25°C)

| Parameter | R3788 | | | R4332 | | | Unit |
|---|-------|-------------------------|------|-------|-------------------------|------|---------|
| | Min. | Typ. | Max. | Min. | Typ. | Max. | |
| Cathode Sensitivity | | | | | | | |
| Quantum Efficiency at Peak Wavelength | — | 30 | — | — | 40 | — | % |
| | | (at 250nm) | | | (at 210nm) | | |
| Luminous ^B | 100 | 120 | — | 100 | 120 | — | μA/lm |
| Radiant at 194nm | — | 31 | — | — | 60 | — | mA/W |
| 210nm | — | 50 | — | — | 68 | — | mA/W |
| 420nm | — | 90 | — | — | 90 | — | mA/W |
| Red/White Ratio ^C | — | 0.01 | — | — | 0.01 | — | — |
| Blue ^D | — | 10 | — | — | 10 | — | μA/lm-b |
| Anode Sensitivity | | | | | | | |
| Luminous ^E | 500 | 1200 | — | 500 | 1200 | — | A/lm |
| Radiant at 194nm | — | 3.1 × 10 ⁵ | — | — | 6.0 × 10 ⁵ | — | A/W |
| 210nm | — | 5.0 × 10 ⁵ | — | — | 6.8 × 10 ⁵ | — | A/W |
| 420nm | — | 9.0 × 10 ⁵ | — | — | 9.0 × 10 ⁵ | — | A/W |
| Gain ^E | — | 1.0 × 10 ⁷ | — | — | 1.0 × 10 ⁷ | — | — |
| Anode Dark Current ^F | — | 5 | 50 | — | 5 | 50 | nA |
| (After 30minutes Storage in the darkness) | | | | | | | |
| ENI(Equivalent Noise Input) ^G | — | 1.4 × 10 ⁻¹⁶ | — | — | 1.4 × 10 ⁻¹⁶ | — | W |
| Time Response ^E | | | | | | | |
| Anode Pulse Rise Time ^H | — | 2.2 | — | — | 2.2 | — | ns |
| Electron Transit Time ^I | — | 22 | — | — | 22 | — | ns |
| Transit Time Spread (TTS) ^J | — | 1.2 | — | — | 1.2 | — | ns |
| Anode Current Stability ^K | | | | | | | |
| Light Hysteresis | — | 0.1 | — | — | 0.1 | — | % |
| Voltage Hysteresis | — | 1.0 | — | — | 1.0 | — | % |

NOTES

A: Averaged over any interval of 30 seconds maximum.

B: The light source is a tungsten filament lamp operated at a distribution temperature of 2856K. Supply voltage is 100 volts between the cathode and all other electrodes connected together as anode.

C: Red/White ratio is the quotient of the cathode current measured using a red filter(Toshiba R-68) interposed between the light source and the tube by the cathode current measured with the filter removed under the same conditions as Note B.

D: The value is cathode output current when a blue filter(Corning CS-5-58 polished to 1/2 stock thickness) is interposed between the light source and the tube under the same condition as Note B.

E: Measured with the same light source as Note B and with the voltage distribution ratio shown in Table 1 below.

Table 1: Voltage Distribution Ratio

| Electrodes | K | Dy1 | Dy2 | Dy3 | Dy4 | Dy5 | Dy6 | Dy7 | Dy8 | Dy9 | P |
|--------------------|---|-----|-----|-----|-----|-----|-----|-----|-----|-----|---|
| Distribution Ratio | 1 | 1 | 1 | 1 | 1 | 1 | 1 | 1 | 1 | 1 | 1 |

Supply Voltage : 1000Vdc

K : Cathode, Dy : Dynode, P : Anode

F: Measured with the same supply voltage and voltage distribution ratio as Note E after removal of light.

G: ENI is an indication of the photon-limited signal-to-noise ratio. It refers to the amount of light in watts to produce a signal-to-noise ratio of unity in the output of a photomultiplier tube.

$$ENI = \frac{\sqrt{2q \cdot I_{db} \cdot G \cdot \Delta f}}{S}$$

where q = Electronic charge (1.60 × 10⁻¹⁹ coulomb).

I_{db} = Anode dark current(after 30 minutes storage) in amperes.

G = Gain.

Δf = Bandwidth of the system in hertz. 1 hertz is used.

S = Anode radiant sensitivity in amperes per watt at the wavelength of peak response.

H: The rise time is the time for the output pulse to rise from 10% to 90% of the peak amplitude when the entire photocathode is illuminated by a delta function light pulse.

I: The electron transit time is the interval between the arrival of delta function light pulse at the entrance window of the tube and the time when the anode output reaches the peak amplitude. In measurement, the whole photocathode is illuminated.

J: Also called transit time jitter. This is the fluctuation in electron transit time between individual pulses in the signal photoelectron mode, and may be defined as the FWHM of the frequency distribution of electron transit times.

K: Hysteresis is temporary instability in anode current after light and voltage are applied.

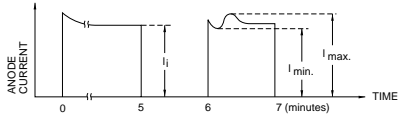

TPMSB0002EA

Figure 2: Anode Luminous Sensitivity and Gain Characteristics

$$\text{Hysteresis} = \frac{I_{\max} - I_{\min}}{I_j} \times 100(\%)$$

(1)Current Hysteresis

The tube is operated at 750 volts with an anode current of 1 micro-ampere for 5 minutes. The light is then removed from the tube for a minute. The tube is then re-illuminated by the previous light level for a minute to measure the variation.

(2)Voltage Hysteresis

The tube is operated at 300 volts with an anode current of 0.1 micro-ampere for 5 minutes. The light is then removed from the tube and the supply voltage is quickly increased to 800 volts. After a minute, the supply voltage is then reduced to the previous value and the tube is re-illuminated for a minute to measure the variation.

Figure 3: Typical Time Response

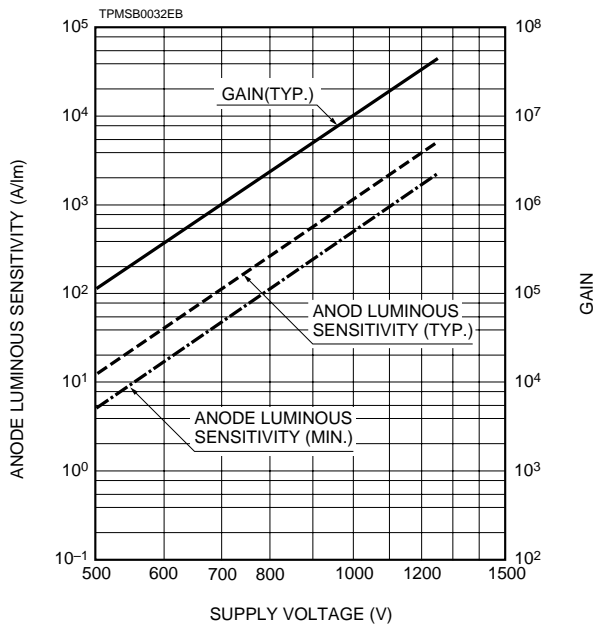

Figure 4: Typical ENI with Wavelength

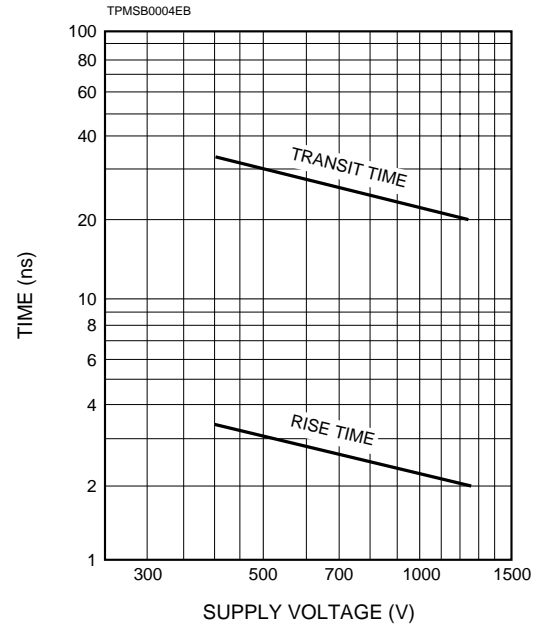
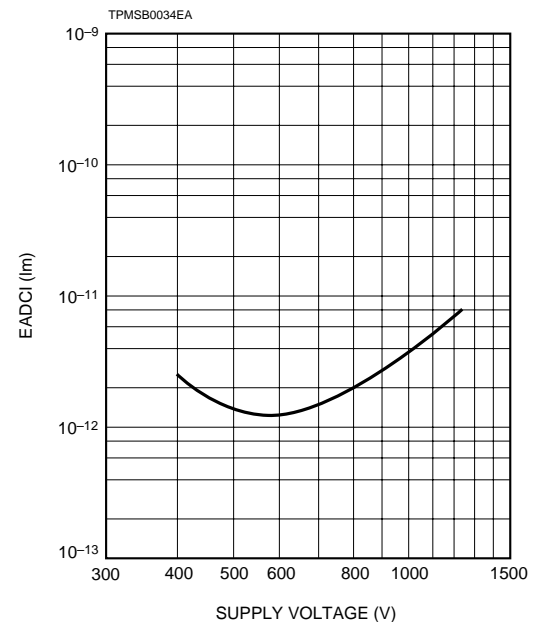
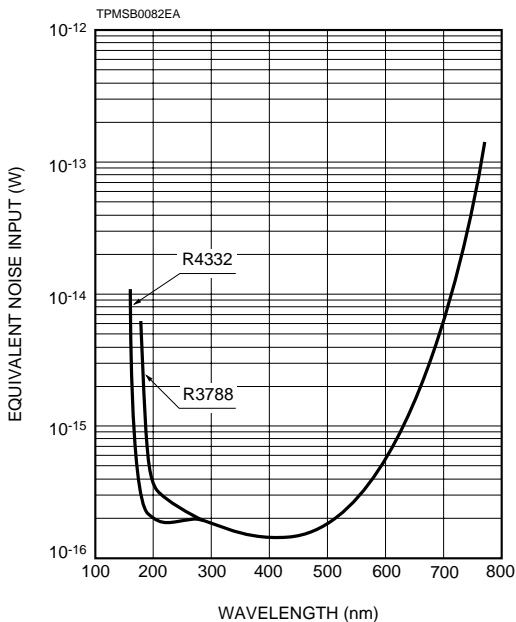

Figure 5: Typical EADCI (Equivalent Anode Dark Current Input) vs. Supply Voltage



PHOTOMULTIPLIER TUBES R3788, R4332

Unit : mm

Figure 6: Dimensional Outline and Basing Diagram

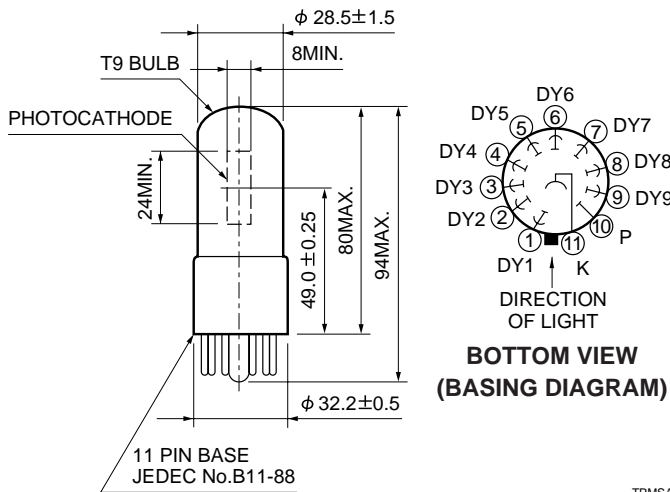

TPMSA0005EB

Figure 7: Socket E678-11A (Option)

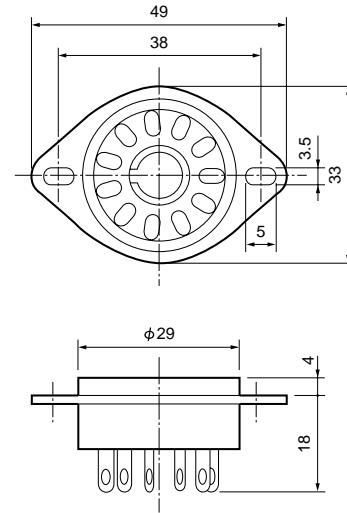

TACCA0008EB

Figure 8: D Type Socket Assembly E717-21 (Option)

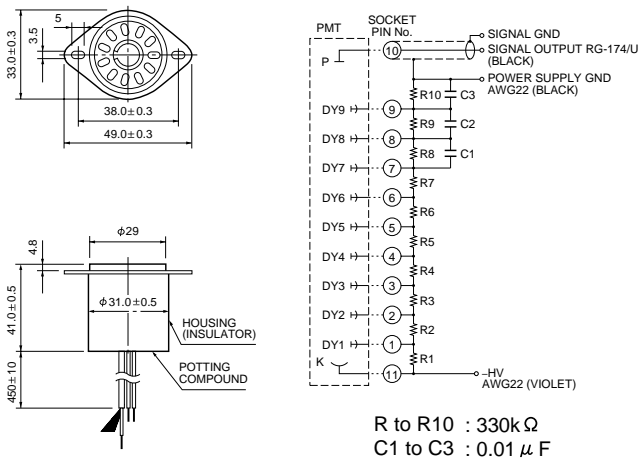

TACCA0002ED

※ Hamamatsu also provides C4900 series compact high voltage power supplies and C6270 series DP type socket assemblies which incorporate a DC to DC converter type high voltage power supply.

Warning—Personal Safety Hazards
Electrical Shock—Operating voltages applied to this device present a shock hazard.

HAMAMATSU

HAMAMATSU PHOTONICS K.K., Electron Tube Center

314-5, Shimokanzo, Toyooka-village, Iwata-gun, Shizuoka-ken, 438-0193, Japan, Telephone: (81)539/62-5248, Fax: (81)539/62-2205

U.S.A.: Hamamatsu Corporation: 360 Foothill Road, Bridgewater, N.J. 08807-0910, U.S.A., Telephone: (1)908-231-0960, Fax: (1)908-231-1218

Germany: Hamamatsu Photonics Deutschland GmbH: Arzbergerstr. 10, D-82211 Herrsching am Ammersee, Germany, Telephone: (49)8152-375-0, Fax: (49)8152-2658

France: Hamamatsu Photonics France S.A.R.L.: 8, Rue du Saule Trapu, Parc du Moulin de Massy, 91882 Massy Cedex, France, Telephone: (33)1 69 53 71 00, Fax: (33)1 69 53 71 10

United Kingdom: Hamamatsu Photonics UK Limited: Lough Point, 2 Gladbeck Way, Windmill Hill, Enfield, Middlesex EN2 7JA, United Kingdom, Telephone: (44)181-367-3560, Fax: (44)181-367-6384

North Europe: Hamamatsu Photonics Norden AB: Färögatan 7, S-164-40 Kista Sweden, Telephone: (46)8-703-29-50, Fax: (46)8-750-58-95

Italy: Hamamatsu Photonics Italia: S.R.L.: Via Della Moia, 1/E, 20020 Arese, (Milano), Italy, Telephone: (39)2-935 81 733, Fax: (39)2-935 81 741

TPMS1021E01
FEB. 1994