

# GaAsP photodiode

## Diffusion type

Photodiode for visible light detection

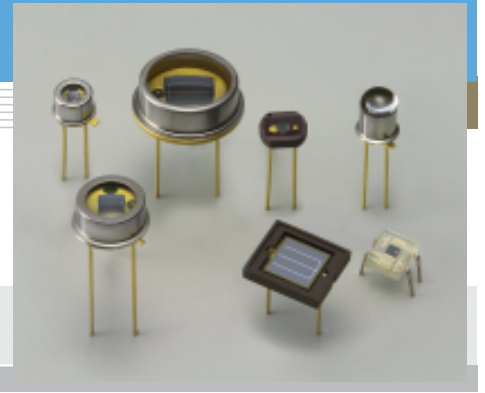

### Features

- Low dark current
- High stability

### Applications

- Analytical instrument
- Color identification

### ■ General ratings / Absolute maximum ratings

Type No.	Dimensional outline/ Window material *	Package	Active area size (mm)	Effective active area (mm <sup>2</sup> )	Absolute maximum ratings		
					Reverse voltage VR Max. (V)	Operating temperature Topr (°C)	Storage temperature Tstg (°C)
G1115	①/K	TO-18	1.3 × 1.3	1.66	5	-30 to +80	-40 to +85
G1116	②/K	TO-5	2.7 × 2.7	7.26			
G1117	③/K	TO-8	5.6 × 5.6	29.3			
G1118	④/R	Ceramic	1.3 × 1.3	1.66			
G1120	⑤/R	Ceramic	5.6 × 5.6	29.3			
G3067	⑥/L	TO-18	1.3 × 1.3	1.66			
G2711-01	⑦/R	Plastic	1.3 × 1.3	1.66			

### ■ Electrical and optical characteristics (Typ. Ta=25 °C, unless otherwise noted)

Type No.	Spectral response range $\lambda$ (nm)	Peak sensitivity wavelength $\lambda_p$ (nm)	Photo sensitivity S (A/W)			Short circuit current Isc 100 k		Dark current Id Max.		Temp. coefficient of Id TCID (times/°C)	Rise time tr VR=0 V RL=1 k $\Omega$ ( $\mu$ s)	Terminal capacitance Ct VR=0 V f=10 kHz (pF)	Shunt resistance Rsh VR=10 mV		NEP (W/Hz <sup>1/2</sup> )
			$\lambda_p$	GaP LED 560 nm	He-Ne laser 633 nm	Min. ( $\mu$ A)	Typ. ( $\mu$ A)	VR=10 mV (pA)	VR=1 V (pA)				Min. (G $\Omega$ )	Typ. (G $\Omega$ )	
G1115	300 to 680	640	0.3	0.29	0.29	0.12	0.15	1	10	1.07	300	10	80	1.5 × 10 <sup>-15</sup>	
G1116						0.45	0.6	2.5	25					2.5 × 10 <sup>-15</sup>	
G1117						2	2.5	5	50					3.5 × 10 <sup>-15</sup>	
G1118						0.12	0.15	1	10					1.5 × 10 <sup>-15</sup>	
G1120						2	2.5	5	50					3.5 × 10 <sup>-15</sup>	
G3067						0.75	0.95	1	10					1.5 × 10 <sup>-15</sup>	
G2711-01						0.15	0.18	1	10					1.5 × 10 <sup>-15</sup>	

\* Window material K: borosilicate glass, L: lens type borosilicate glass, R: resin coating

## Spectral response

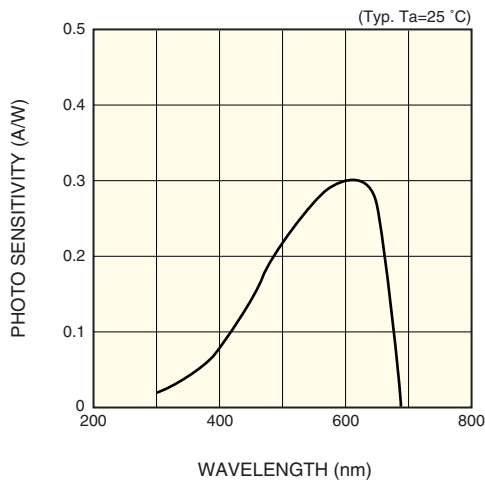

KGPD0019EA

## Photo sensitivity temperature characteristic

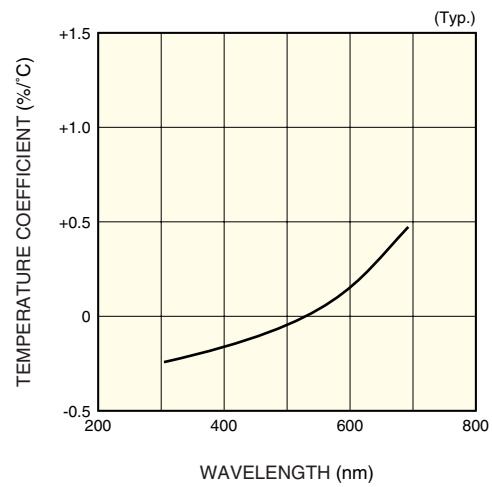

KGPD0020EA

## Rise time vs. load resistance

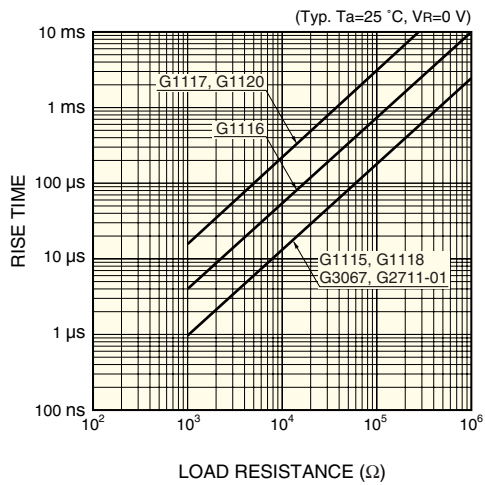

KGPD0021EA

## Dark current vs. reverse voltage

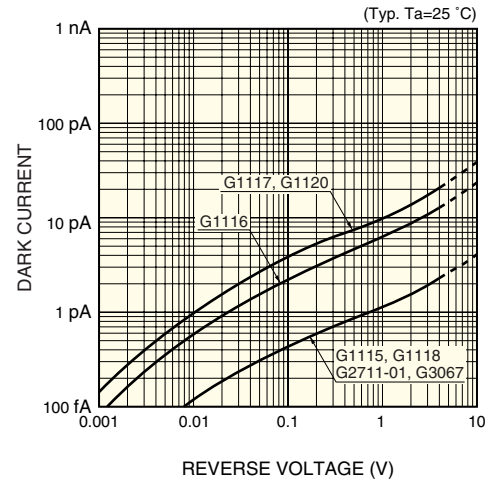

KGPD0022EA

## Shunt resistance vs. ambient temperature

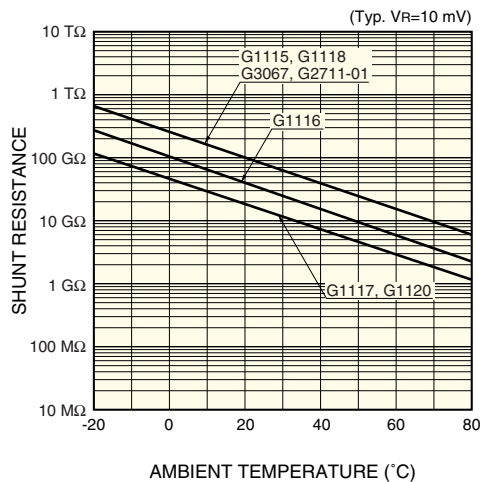

KGPD0023EA

## Short circuit current linearity

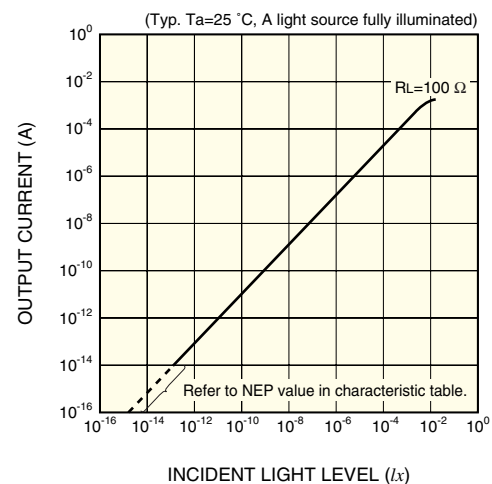

KGPD0008EA

## Dimensional outlines (unit: mm)

① G1115

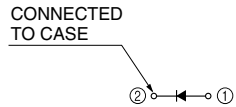
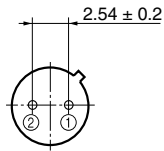
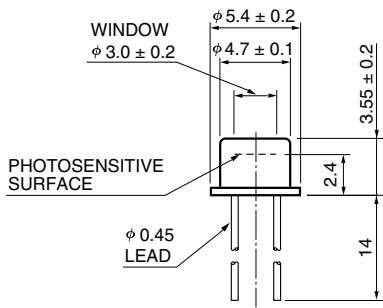

Borosilicate glass window may extend a maximum of 0.1 mm beyond the upper surface of the cap.

KGPDA0012EA

② G1116

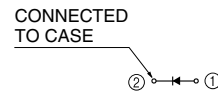
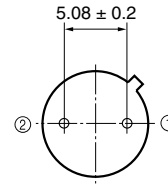
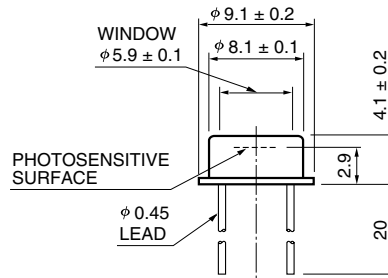

Borosilicate glass window may extend a maximum of 0.2 mm beyond the upper surface of the cap.

KGPDA0013EA

③ G1117

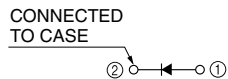
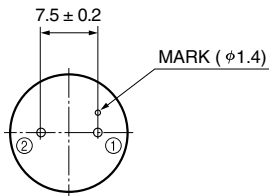
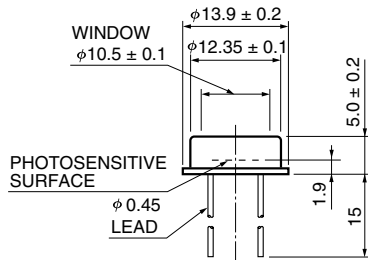

Borosilicate glass window may extend a maximum of 0.2 mm beyond the upper surface of the cap.

KGPDA0014EA

④ G1118

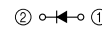
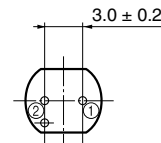
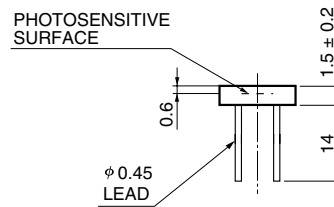
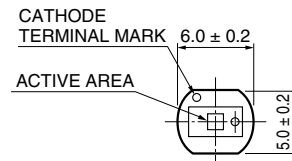

KGPDA0002EA

## ⑤ G1120

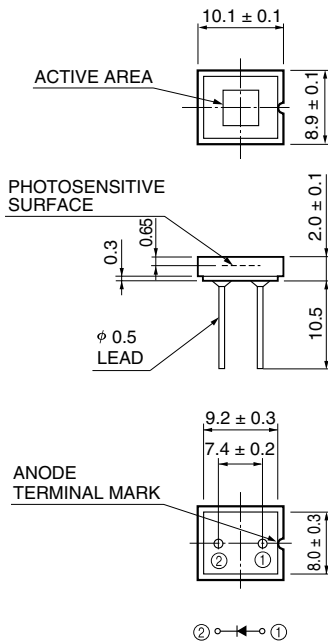

KGPDA0008EA

## ⑥ G3067

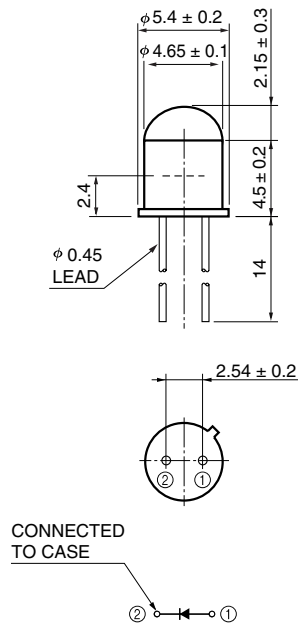

KGPDA0009EA

## ⑦ G2711-01

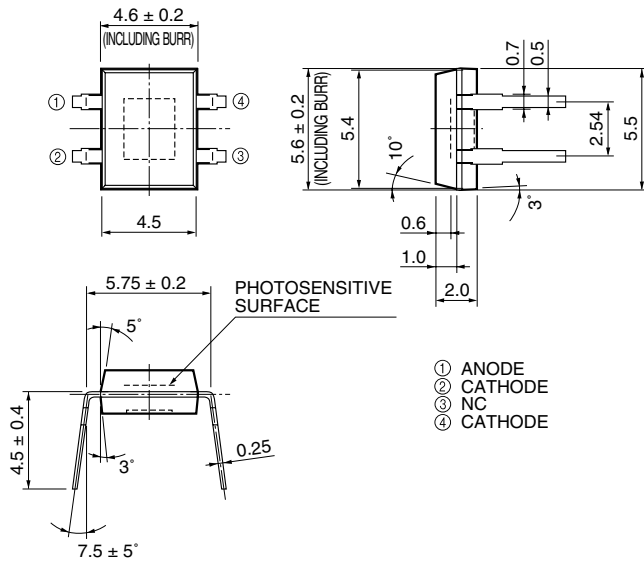

KGPDA0003EA

# HAMAMATSU

Information furnished by HAMAMATSU is believed to be reliable. However, no responsibility is assumed for possible inaccuracies or omissions. Specifications are subject to change without notice. No patent rights are granted to any of the circuits described herein. ©2001 Hamamatsu Photonics K.K.

HAMAMATSU PHOTONICS K.K., Solid State Division

1126-1 Ichino-cho, Hamamatsu City, 435-8558 Japan, Telephone: (81) 053-434-3311, Fax: (81) 053-434-5184, <http://www.hamamatsu.com>

U.S.A.: Hamamatsu Corporation: 360 Foothill Road, P.O.Box 6910, Bridgewater, N.J. 08807-0910, U.S.A., Telephone: (1) 908-231-0960, Fax: (1) 908-231-1218

Germany: Hamamatsu Photonics Deutschland GmbH: Arzbergerstr. 10, D-82211 Herrsching am Ammersee, Germany, Telephone: (49) 08152-3750, Fax: (49) 08152-2658

France: Hamamatsu Photonics France S.A.R.L.: 8, Rue du Saule Trapu, Parc du Moulin de Massy, 91882 Massy Cedex, France, Telephone: 33-(1) 69 53 71 00, Fax: 33-(1) 69 53 71 10

United Kingdom: Hamamatsu Photonics UK Limited: 2 Howard Court, 10 Tewin Road, Welwyn Garden City, Hertfordshire AL7 1BW, United Kingdom, Telephone: (44) 1707-294888, Fax: (44) 1707-325777

North Europe: Hamamatsu Photonics Norden AB: Smidsvågen 12, SE-171 41 Solna, Sweden, Telephone: (46) 8-509-031-00, Fax: (46) 8-509-031-01

Italy: Hamamatsu Photonics Italia S.R.L.: Strada della Moia, 1/E, 20020 Arese, (Milano), Italy, Telephone: (39) 02-935-81-733, Fax: (39) 02-935-81-741