

IRF540, IRF541, IRF542, IRF543, RF1S540, RF1S540SM

25A and 28A, 80V and 100V, 0.077 and 0.100 Ohm,
N-Channel Power MOSFETs

November 1997

Features

- 25A and 28A, 80V and 100V
- $r_{DS(ON)} = 0.077\Omega$ and 0.100Ω
- Single Pulse Avalanche Energy Rated
- Nanosecond Switching Speeds
- Linear Transfer Characteristics
- High Input Impedance
- Related Literature
 - TB334 "Guidelines for Soldering Surface Mount Components to PC Boards"

Description

These are N-Channel enhancement mode silicon gate power field effect transistors. They are advanced power MOSFETs designed, tested, and guaranteed to withstand a specified level of energy in the breakdown avalanche mode of operation. All of these power MOSFETs are designed for applications such as switching regulators, switching converters, motor drivers, relay drivers, and drivers for high power bipolar switching transistors requiring high speed and low gate drive power. These types can be operated directly from integrated circuits.

Formerly developmental type TA17421.

Ordering Information

PART NUMBER	PACKAGE	BRAND
IRF540	TO-220AB	IRF540
IRF541	TO-220AB	IRF541
IRF542	TO-220AB	IRF542
IRF543	TO-220AB	IRF543
RF1S540	TO-262AA	RF1S540
RF1S540SM	TO-263AB	RF1S540SM

NOTE: When ordering, use the entire part number. Add the suffix 9A to obtain the TO-263AB variant in the tape and reel, i.e., RF1S540SM9A.

Symbol

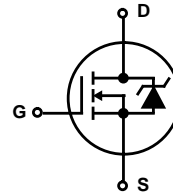

Packaging

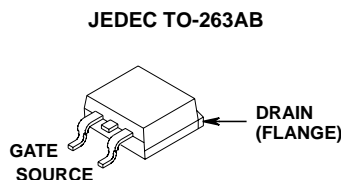
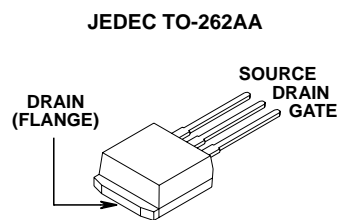
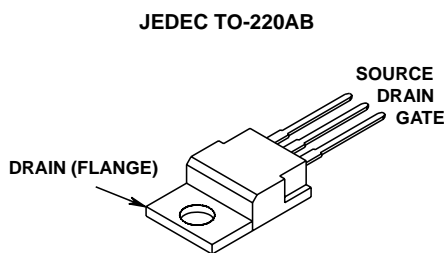

IRF540, IRF541, IRF542, IRF543, RF1S540, RF1S540SM

Absolute Maximum Ratings $T_C = 25^\circ\text{C}$, Unless Otherwise Specified

	IRF540, RF1S540, RF1S540SM				UNITS
	IRF541	IRF542	IRF543		
Drain to Source Breakdown Voltage (Note 1)..... V_{DS}	100	80	100	80	V
Drain to Gate Voltage ($R_{GS} = 20k\Omega$) (Note 1)..... V_{DGR}	100	80	100	80	V
Continuous Drain Current..... I_D	28	28	25	25	A
$T_C = 100^\circ\text{C}$ I_D	20	20	17	17	A
Pulsed Drain Current (Note 3)..... I_{DM}	110	110	100	100	A
Gate to Source Voltage..... V_{GS}	± 20	± 20	± 20	± 20	V
Maximum Power Dissipation..... P_D	150	150	150	150	W
Dissipation Derating Factor.....	1	1	1	1	$W/^\circ\text{C}$
Single Pulse Avalanche Energy Rating (Note 4)..... E_{AS}	230	230	230	230	mJ
Operating and Storage Temperature..... T_J, T_{STG}	-55 to 175	-55 to 175	-55 to 175	-55 to 175	$^\circ\text{C}$
Maximum Temperature for Soldering					
Leads at 0.063in (1.6mm) from Case for 10s..... T_L	300	300	300	300	$^\circ\text{C}$
Package Body for 10s, See Techbrief 334..... T_{pkg}	260	260	260	260	$^\circ\text{C}$

CAUTION: Stresses above those listed in "Absolute Maximum Ratings" may cause permanent damage to the device. This is a stress only rating and operation of the device at these or any other conditions above those indicated in the operational sections of this specification is not implied.

NOTE:

- $T_J = 25^\circ\text{C}$ to $T_J = 150^\circ\text{C}$.

Electrical Specifications $T_C = 25^\circ\text{C}$, Unless Otherwise Specified

PARAMETER	SYMBOL	TEST CONDITIONS	MIN	TYP	MAX	UNITS
Drain to Source Breakdown Voltage IRF540, IRF542, RF1S540, RF1S540SM	BV_{DSS}	$I_D = 250\mu\text{A}, V_{GS} = 0\text{V}$ (Figure 10)	100	-	-	V
			80	-	-	V
IRF541, IRF543						
Gate to Threshold Voltage	$V_{GS(TH)}$	$V_{GS} = V_{DS}, I_D = 250\mu\text{A}$	2	-	4	V
Zero Gate Voltage Drain Current	I_{DSS}	$V_{DS} = \text{Rated } BV_{DSS}, V_{GS} = 0\text{V}$	-	-	25	μA
		$V_{DS} = 0.8 \times \text{Rated } BV_{DSS}, V_{GS} = 0\text{V}$ $T_J = 150^\circ\text{C}$	-	-	250	μA
On-State Drain Current (Note 2) IRF540, IRF541, RF1S540, RF1S540SM	$I_{D(ON)}$	$V_{DS} > I_{D(ON)} \times r_{DS(ON) \text{ MAX}}, V_{GS} = 10\text{V}$ (Figure 7)	28	-	-	A
			25	-	-	A
IRF542, IRF543						
Gate to Source Leakage Current	I_{GSS}	$V_{GS} = \pm 20\text{V}$	-	-	± 100	nA
Drain to Source On Resistance (Note 2) IRF540, IRF541, RF1S540, RF1S540SM	$r_{DS(ON)}$	$I_D = 17\text{A}, V_{GS} = 10\text{V}$ (Figures 8, 9)	-	0.060	0.077	Ω
			-	0.080	0.100	Ω
IRF542, IRF543						
Forward Transconductance (Note 2)	g_{fs}	$V_{DS} \geq 50\text{V}, I_D = 17\text{A}$ (Figure 12)	8.7	13	-	S
Turn-On Delay Time	$t_{d(ON)}$	$V_{DD} = 50\text{V}, I_D \approx 28\text{A}, R_G \approx 9.1\Omega, R_L = 1.7\Omega$ (Figures 17, 18) MOSFET Switching Times are Essentially Independent of Operating Temperature	-	15	23	ns
Rise Time	t_r		-	70	110	ns
Turn-Off Delay Time	$t_{d(OFF)}$		-	40	60	ns
Fall Time	t_f		-	50	75	ns
Total Gate Charge (Gate to Source + Gate to Drain)	$Q_{g(TOT)}$		$V_{GS} = 10\text{V}, I_D = 28\text{A}, V_{DS} = 0.8 \times \text{Rated } BV_{DSS}, I_{g(REF)} = 1.5\text{mA}$ (Figures 14, 19, 20) Gate Charge is Essentially Independent of Op- erating Temperature	-	38	59
Gate to Source Charge	Q_{gs}		-	8	-	nC
Gate to Drain "Miller" Charge	Q_{gd}		-	21	-	nC

IRF540, IRF541, IRF542, IRF543, RF1S540, RF1S540SM

Electrical Specifications $T_C = 25^\circ\text{C}$, Unless Otherwise Specified **(Continued)**

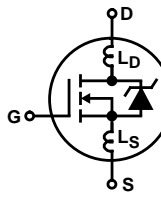
PARAMETER	SYMBOL	TEST CONDITIONS		MIN	TYP	MAX	UNITS
Input Capacitance	C_{ISS}	$V_{DS} = 25\text{V}$, $V_{GS} = 0\text{V}$, $f = 1\text{MHz}$ (Figure 11)		-	1450	-	pF
Output Capacitance	C_{OSS}			-	550	-	pF
Reverse Transfer Capacitance	C_{RSS}			-	100	-	pF
Internal Drain Inductance	L_D	Measured From the Contact Screw on Tab To Center of Die	Modified MOSFET Symbol Showing the Internal Devices Inductances 	-	3.5	-	nH
		Measured From the Drain Lead, 6mm (0.25in) from Package to Center of Die		-	4.5	-	nH
Internal Source Inductance	L_S	Measured From the Source Lead, 6mm (0.25in) From Header to Source Bonding Pad			-	7.5	-
Thermal Resistance Junction to Case	$R_{\theta JC}$			-	-	1	$^\circ\text{C/W}$
Thermal Resistance Junction to Ambient	$R_{\theta JA}$	Free Air Operation		-	-	80	$^\circ\text{C/W}$
	$R_{\theta JA}$	RF1S540SM Mounted on FR-4 Board with Minimum Mounting Pad		-	-	62	$^\circ\text{C/W}$

Source to Drain Diode Specifications

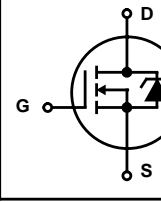
PARAMETER	SYMBOL	TEST CONDITIONS		MIN	TYP	MAX	UNITS
Continuous Source to Drain Current	I_{SD}	Modified MOSFET Symbol Showing the Integral Reverse P-N Junction Diode 		-	-	28	A
Pulse Source to Drain Current (Note 3)	I_{SDM}			-	-	110	A
Source to Drain Diode Voltage (Note 2)	V_{SD}	$T_J = 25^\circ\text{C}$, $I_{SD} = 27\text{A}$, $V_{GS} = 0\text{V}$ (Figure 13)		-	-	2.5	V
Reverse Recovery Time	t_{rr}	$T_J = 25^\circ\text{C}$, $I_{SD} = 28\text{A}$, $dI_{SD}/dt = 100\text{A}/\mu\text{s}$		70	150	300	ns
Reverse Recovery Charge	Q_{RR}	$T_J = 25^\circ\text{C}$, $I_{SD} = 28\text{A}$, $dI_{SD}/dt = 100\text{A}/\mu\text{s}$		0.44	1.0	1.9	μC

NOTES:

- Pulse test: pulse width $\leq 300\mu\text{s}$, duty cycle $\leq 2\%$.
- Repetitive rating: pulse width limited by maximum junction temperature. See Transient Thermal Impedance curve (Figure 3).
- $V_{DD} = 25\text{V}$, starting $T_J = 25^\circ\text{C}$, $L = 440\mu\text{H}$, $R_G = 25\Omega$, peak $I_{AS} = 28\text{A}$. (Figures 15, 16).

IRF540, IRF541, IRF542, IRF543, RF1S540, RF1S540SM

Typical Performance Curves Unless Otherwise Specified

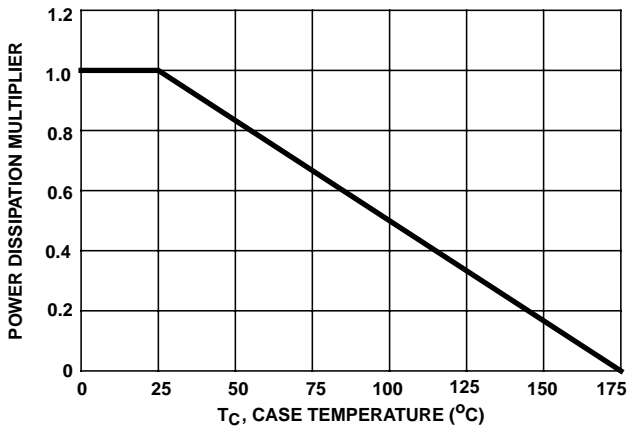

FIGURE 1. NORMALIZED POWER DISSIPATION vs CASE TEMPERATURE

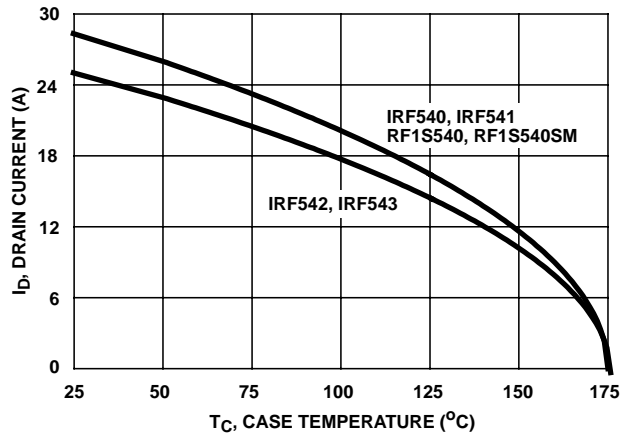

FIGURE 2. MAXIMUM CONTINUOUS DRAIN CURRENT vs CASE TEMPERATURE

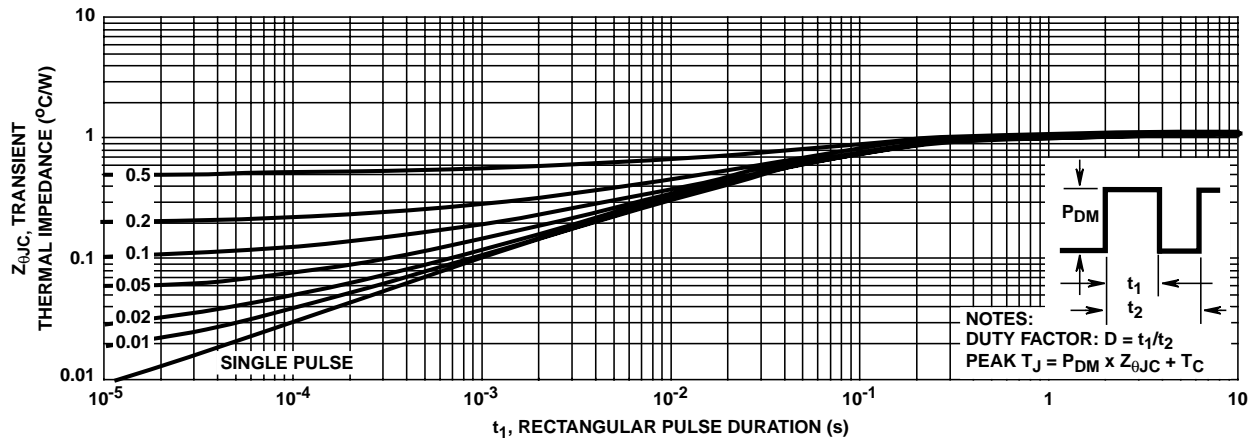

FIGURE 3. MAXIMUM TRANSIENT THERMAL IMPEDANCE

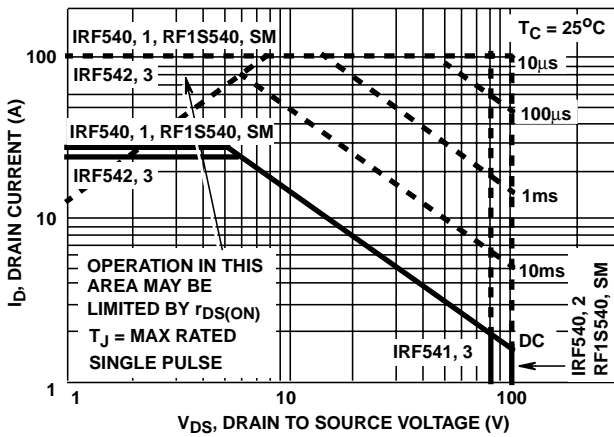

FIGURE 4. FORWARD BIAS SAFE OPERATING AREA

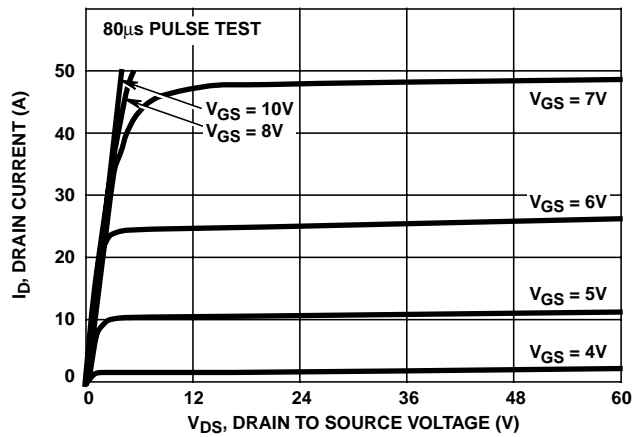

FIGURE 5. OUTPUT CHARACTERISTICS

IRF540, IRF541, IRF542, IRF543, RF1S540, RF1S540SM

Typical Performance Curves Unless Otherwise Specified (Continued)

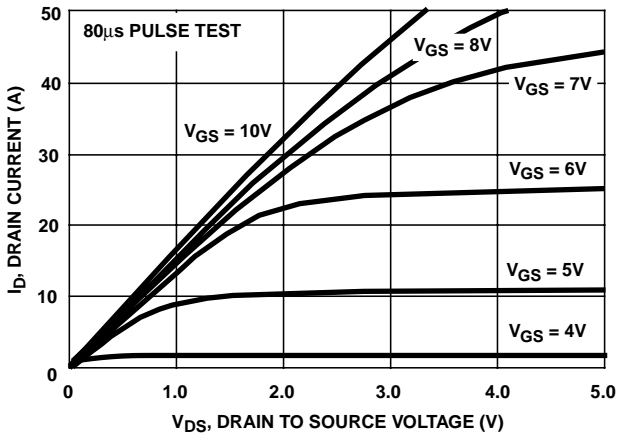

FIGURE 6. SATURATION CHARACTERISTICS

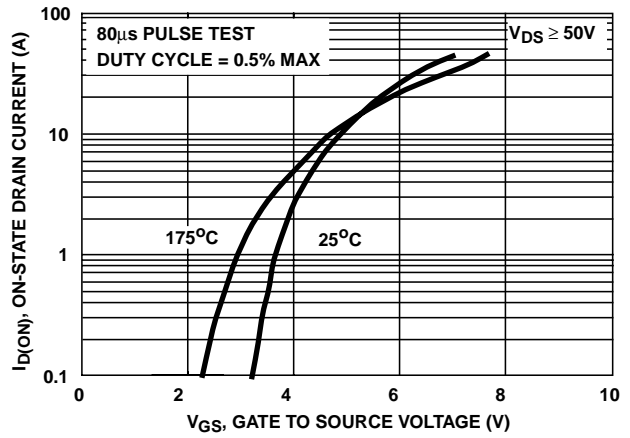

FIGURE 7. TRANSFER CHARACTERISTICS

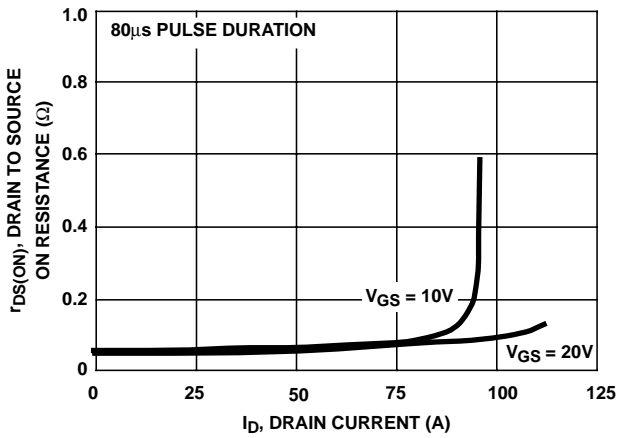

FIGURE 8. DRAIN TO SOURCE ON RESISTANCE vs GATE VOLTAGE AND DRAIN CURRENT

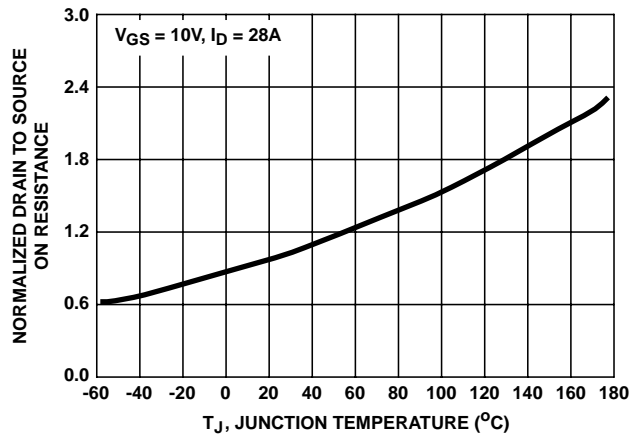

FIGURE 9. NORMALIZED DRAIN TO SOURCE ON RESISTANCE vs JUNCTION TEMPERATURE

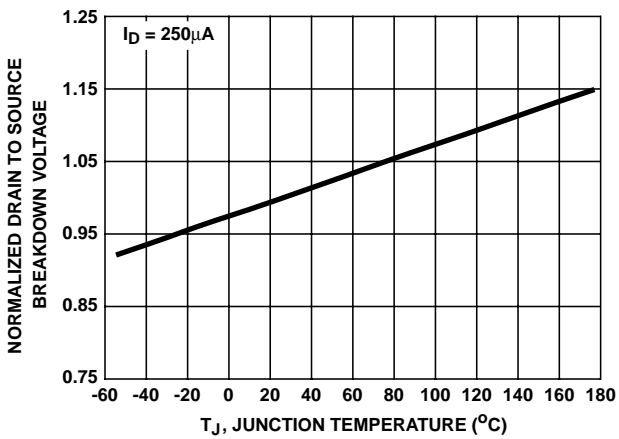

FIGURE 10. NORMALIZED DRAIN TO SOURCE BREAKDOWN VOLTAGE vs JUNCTION TEMPERATURE

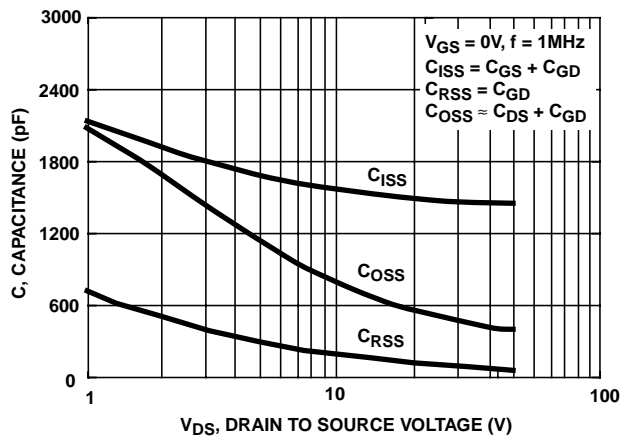

FIGURE 11. CAPACITANCE vs DRAIN TO SOURCE VOLTAGE

IRF540, IRF541, IRF542, IRF543, RF1S540, RF1S540SM

Typical Performance Curves Unless Otherwise Specified (Continued)

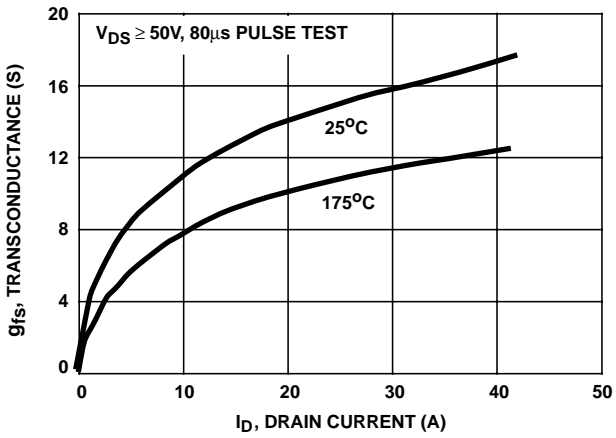

FIGURE 12. TRANSCONDUCTANCE vs DRAIN CURRENT

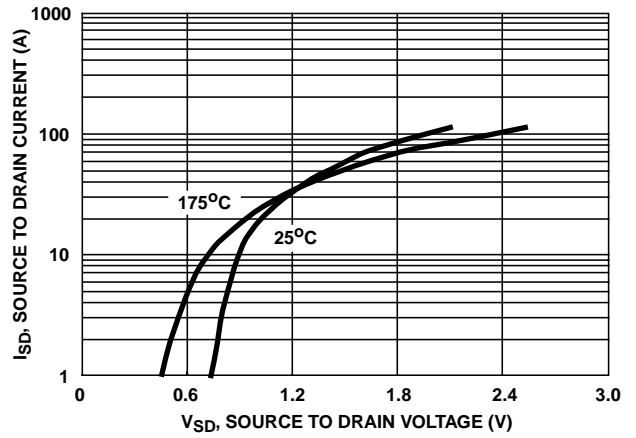

FIGURE 13. SOURCE TO DRAIN DIODE VOLTAGE

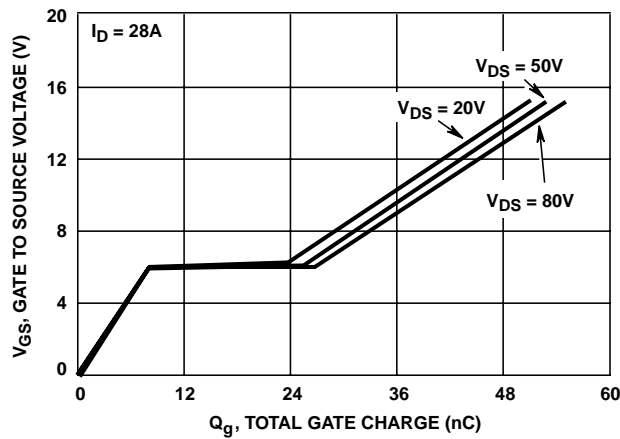

FIGURE 14. GATE TO SOURCE VOLTAGE vs GATE CHARGE

Test Circuits and Waveforms

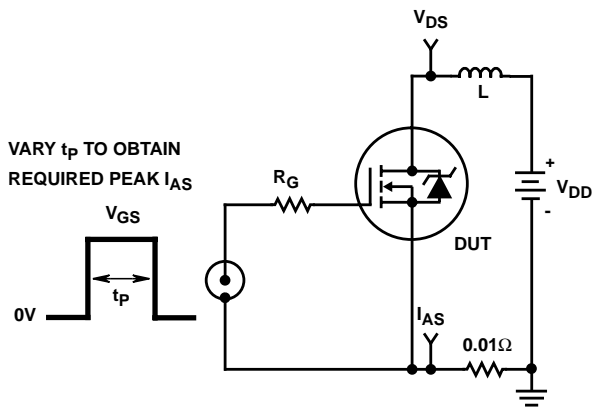

FIGURE 15. UNCLAMPED ENERGY TEST CIRCUIT

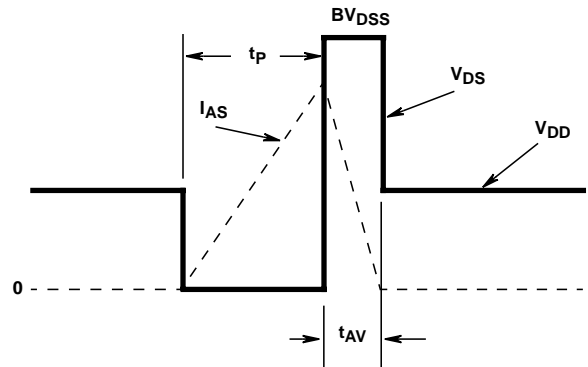

FIGURE 16. UNCLAMPED ENERGY WAVEFORMS

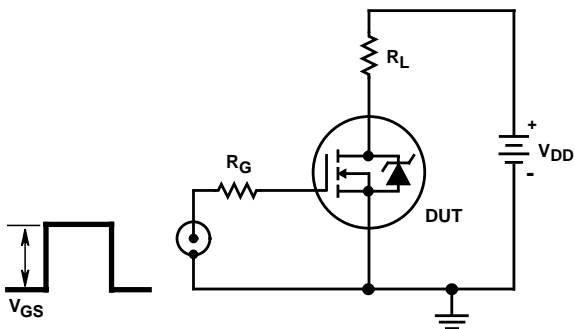

FIGURE 17. SWITCHING TIME TEST CIRCUIT

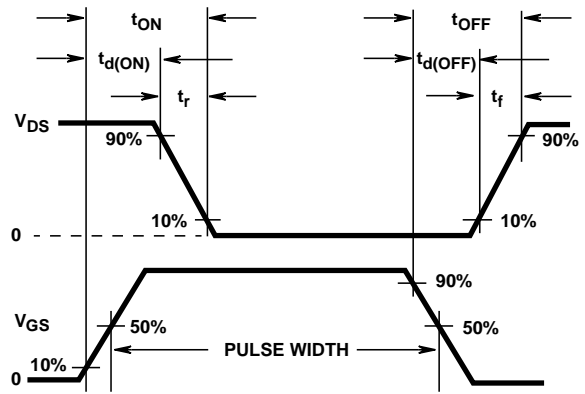

FIGURE 18. RESISTIVE SWITCHING WAVEFORMS

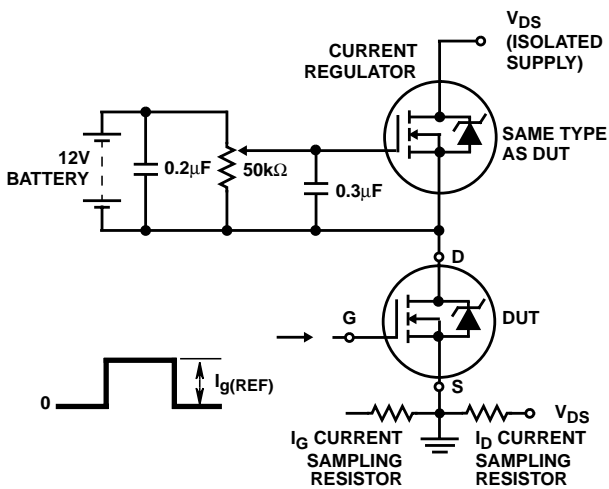

FIGURE 19. GATE CHARGE TEST CIRCUIT

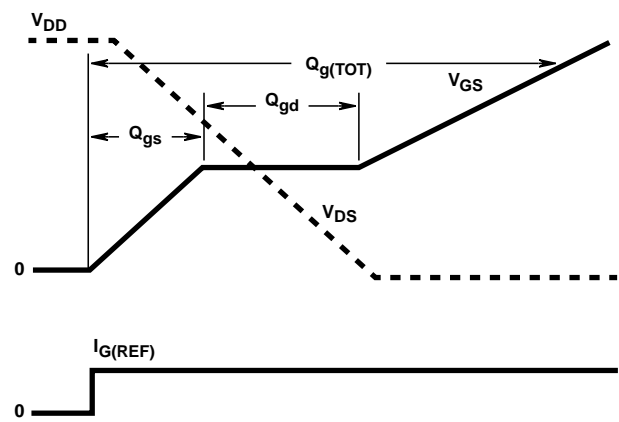

FIGURE 20. GATE CHARGE WAVEFORMS