

---

# HD74ALVCH162820

## 3.3-V 10-bit Flip Flops with Dual Outputs and 3-state Outputs

# HITACHI

ADE-205-185B (Z)  
3rd. Edition  
December 1999

---

### Description

The HD74ALVCH162820 flip flops are edge triggered D-type flip flops. On the positive transition of the clock (CLK) input, the device provides true data at the Q outputs. A buffered output enable ( $\overline{OE}$ ) input can be used to place the eight outputs in either a normal logic state (high or low logic levels) or a high impedance state. In the high impedance state, the outputs neither load nor drive the bus lines significantly. The high impedance state and increased drive provide the capability to drive bus line without need for interface or pullup components.  $\overline{OE}$  does not affect the internal operations of the flip flops. Old data can be retained or new data can be entered while the outputs are in the high impedance state. Active bus hold circuitry is provided to hold unused or floating data inputs at a valid logic level. All outputs, which are designed to sink up to 12 mA, include 26  $\Omega$  resistors to reduce overshoot and undershoot.

### Features

- $V_{CC} = 2.3 \text{ V to } 3.6 \text{ V}$
- Typical  $V_{OL}$  ground bounce  $< 0.8 \text{ V}$  (@ $V_{CC} = 3.3 \text{ V}$ ,  $T_a = 25^\circ\text{C}$ )
- Typical  $V_{OH}$  undershoot  $> 2.0 \text{ V}$  (@ $V_{CC} = 3.3 \text{ V}$ ,  $T_a = 25^\circ\text{C}$ )
- High output current  $\pm 12 \text{ mA}$  (@ $V_{CC} = 3.0 \text{ V}$ )
- Bus hold on data inputs eliminates the need for external pullup / pulldown resistors
- All outputs have equivalent 26  $\Omega$  series resistors, so no external resistors are required.

---

## HD74ALVCH162820

---

### Function Table

Inputs			Output Q
$\overline{OEn}^2$	CLK	D	
L	↑	H	H
L	↑	L	L
L	L	X	$Q_0^{n-1}$
H	X	X	Z

H : High level

L : Low level

X : Immaterial

Z : High impedance

↑ : Low to high transition

Notes: 1. Output level before the indicated steady state input conditions were established.

2.  $n = 1, 2$

**Pin Arrangement**

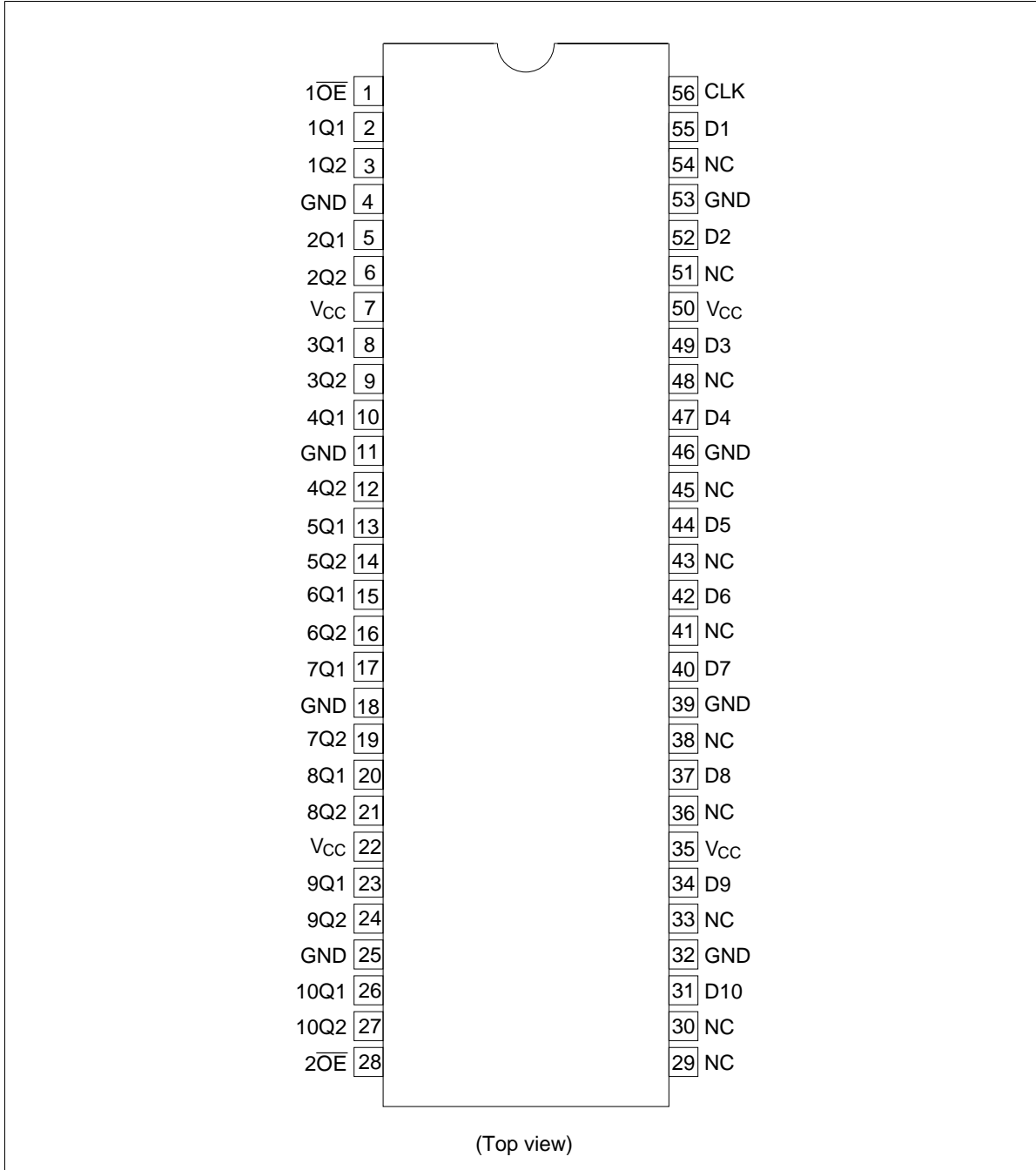

# HD74ALVCH162820

## Absolute Maximum Ratings

Item	Symbol	Ratings	Unit	Conditions
Supply voltage	$V_{CC}$	-0.5 to 4.6	V	
Input voltage <sup>*1</sup>	$V_I$	-0.5 to 4.6	V	
Output voltage <sup>*1,2</sup>	$V_O$	-0.5 to $V_{CC} + 0.5$	V	
Input clamp current	$I_{IK}$	-50	mA	$V_I < 0$
Output clamp current	$I_{OK}$	$\pm 50$	mA	$V_O < 0$ or $V_O > V_{CC}$
Continuous output current	$I_O$	$\pm 50$	mA	$V_O = 0$ to $V_{CC}$
$V_{CC}$ , GND current / pin	$I_{CC}$ or $I_{GND}$	$\pm 100$	mA	
Maximum power dissipation at $T_a = 55^\circ\text{C}$ (in still air) <sup>*3</sup>	$P_T$	1	W	TSSOP
Storage temperature	Tstg	-65 to 150	$^\circ\text{C}$	

Notes: Stresses beyond those listed under "absolute maximum ratings" may cause permanent damage to the device. These are stress ratings only, and functional operation of the device at these or any other conditions beyond those indicated under "recommended operating conditions" is not implied. Exposure to absolute maximum rated conditions for extended periods may affect device reliability.

1. The input and output negative voltage ratings may be exceeded if the input and output clamp current ratings are observed.
2. This value is limited to 4.6 V maximum.
3. The maximum package power dissipation is calculated using a junction temperature of  $150^\circ\text{C}$  and a board trace length of 750 mils.

## Recommended Operating Conditions

Item	Symbol	Min	Max	Unit	Conditions
Supply voltage	$V_{CC}$	2.3	3.6	V	
Input voltage	$V_I$	0	$V_{CC}$	V	
Output voltage	$V_O$	0	$V_{CC}$	V	
High level output current	$I_{OH}$	—	-6	mA	$V_{CC} = 2.3\text{ V}$
		—	-8		$V_{CC} = 2.7\text{ V}$
		—	-12		$V_{CC} = 3.0\text{ V}$
Low level output current	$I_{OL}$	—	6	mA	$V_{CC} = 2.3\text{ V}$
		—	8		$V_{CC} = 2.7\text{ V}$
		—	12		$V_{CC} = 3.0\text{ V}$
Input transition rise or fall rate	$\Delta t / \Delta v$	0	10	ns / V	
Operating temperature	$T_a$	-40	85	$^\circ\text{C}$	

Note: Unused control inputs must be held high or low to prevent them from floating.

Logic Diagram

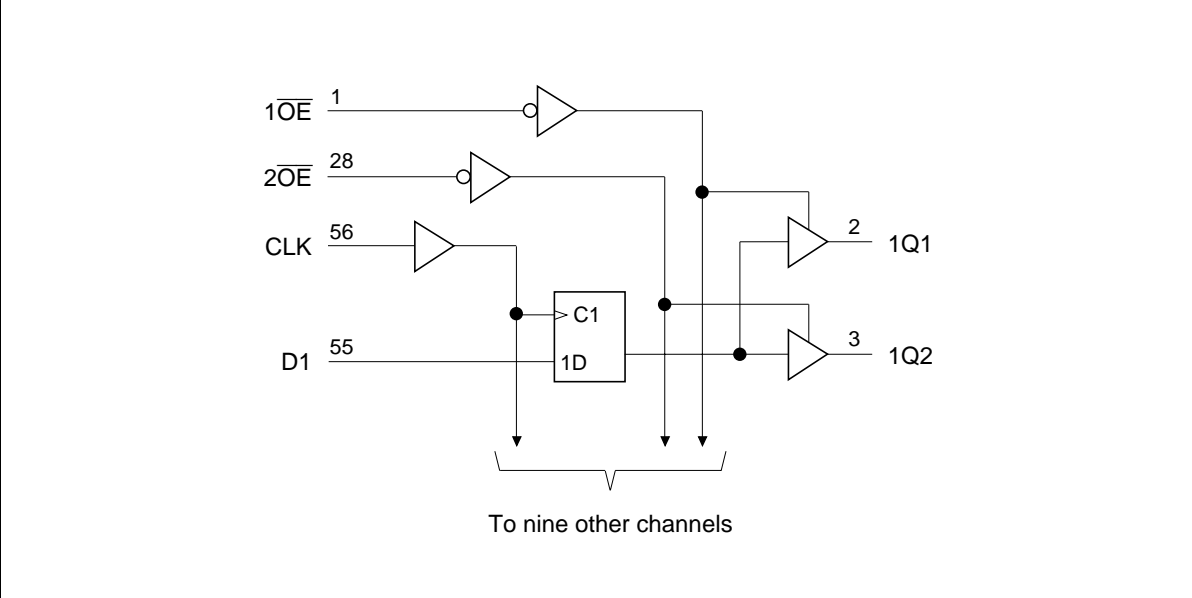

## HD74ALVCH162820

### Electrical Characteristics (Ta = -40 to 85°C)

Item	Symbol	V <sub>CC</sub> (V) <sup>1</sup>	Min	Max	Unit	Test Conditions		
Input voltage	V <sub>IH</sub>	2.3 to 2.7	1.7	—	V			
		2.7 to 3.6	2.0	—				
	V <sub>IL</sub>	2.3 to 2.7	—	0.7				
		2.7 to 3.6	—	0.8				
Output voltage	V <sub>OH</sub>	Min to Max	V <sub>CC</sub> -0.2	—	V	I <sub>OH</sub> = -100 μA		
		2.3	1.9	—		I <sub>OH</sub> = -4 mA, V <sub>IH</sub> = 1.7 V		
		2.3	1.7	—		I <sub>OH</sub> = -6 mA, V <sub>IH</sub> = 1.7 V		
		3.0	2.4	—		I <sub>OH</sub> = -6 mA, V <sub>IH</sub> = 2.0 V		
		2.7	2.0	—		I <sub>OH</sub> = -8 mA, V <sub>IH</sub> = 2.0 V		
		3.0	2.0	—		I <sub>OH</sub> = -12 mA, V <sub>IH</sub> = 2.0 V		
	V <sub>OL</sub>	Min to Max	—	0.2	I <sub>OL</sub> = 100 μA			
		2.3	—	0.4	I <sub>OL</sub> = 4 mA, V <sub>IL</sub> = 0.7 V			
		2.3	—	0.55	I <sub>OL</sub> = 6 mA, V <sub>IL</sub> = 0.7 V			
		3.0	—	0.55	I <sub>OL</sub> = 6 mA, V <sub>IL</sub> = 0.8 V			
		2.7	—	0.6	I <sub>OL</sub> = 8 mA, V <sub>IL</sub> = 0.8 V			
		3.0	—	0.8	I <sub>OL</sub> = 12 mA, V <sub>IL</sub> = 0.8 V			
		Input current	I <sub>IN</sub>	3.6	—	±5	μA	V <sub>IN</sub> = V <sub>CC</sub> or GND
				I <sub>IN (hold)</sub>	2.3	45		—
	2.3		-45	—	V <sub>IN</sub> = 1.7 V			
	3.0		75	—	V <sub>IN</sub> = 0.8 V			
	3.0		-75	—	V <sub>IN</sub> = 2.0 V			
	3.6		—	±500	V <sub>IN</sub> = 0 to 3.6 V			
Off state output current <sup>2</sup>	I <sub>OZ</sub>	3.6	—	±10	μA	V <sub>OUT</sub> = V <sub>CC</sub> or GND		
Quiescent supply current	I <sub>CC</sub>	3.6	—	40	μA	V <sub>IN</sub> = V <sub>CC</sub> or GND		
	ΔI <sub>CC</sub>	3.0 to 3.6	—	750	μA	V <sub>IN</sub> = one input at (V <sub>CC</sub> -0.6) V, other inputs at V <sub>CC</sub> or GND		

Notes: 1. For conditions shown as Min or Max, use the appropriate values under recommended operating conditions.

2. For I/O ports, the parameter I<sub>OZ</sub> includes the input leakage current.

**Switching Characteristics** (Ta = -40 to 85°C)

Item	Symbol	V <sub>cc</sub> (V)	Min	Typ	Max	Unit	FROM (Input)	TO (Output)
Maximum clock frequency	f <sub>max</sub>	2.5±0.2	150	—	—	MHz		
		2.7	150	—	—			
		3.3±0.3	150	—	—			
Propagation delay time	t <sub>PLH</sub>	2.5±0.2	1.0	—	6.4	ns	CLK	Q
		2.7	—	—	6.2			
		3.3±0.3	1.0	—	5.4			
Output enable time	t <sub>ZH</sub>	2.5±0.2	1.0	—	6.9	ns	$\overline{OE}$	Q
		2.7	—	—	6.8			
		3.3±0.3	1.0	—	5.6			
Output disable time	t <sub>ZL</sub>	2.5±0.2	1.3	—	6.2	ns	$\overline{OE}$	Q
		2.7	—	—	5.5			
		3.3±0.3	1.0	—	5.0			
Setup time	t <sub>su</sub>	2.5±0.2	1.7	—	—	ns		
		2.7	1.8	—	—			
		3.3±0.3	1.4	—	—			
Hold time	t <sub>h</sub>	2.5±0.2	1.1	—	—	ns		
		2.7	1.1	—	—			
		3.3±0.3	1.0	—	—			
Pulse width	t <sub>w</sub>	2.5±0.2	3.3	—	—	ns		
		2.7	3.3	—	—			
		3.3±0.3	3.3	—	—			
Input capacitance	C <sub>IN</sub>	3.3	—	3.5	—	pF	Control inputs	
		3.3	—	6.0	—		Data inputs	
Output capacitance	C <sub>O</sub>	3.3	—	7.0	—	pF		

# HD74ALVCH162820

• Test Circuit

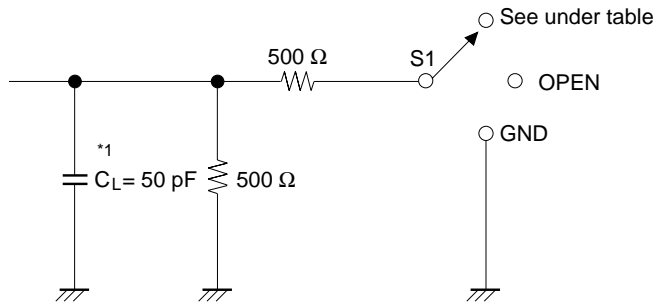

Load Circuit for Outputs

Symbol	$V_{CC}=2.5\pm 0.2V$	$V_{CC}=2.7V, 3.3\pm 0.3V$
$t_{PLH}/t_{PHL}$	OPEN	OPEN
$t_{su}/t_h/t_w$	OPEN	OPEN
$t_{ZH}/t_{HZ}$	GND	GND
$t_{ZL}/t_{LZ}$	4.6 V	6.0 V

Note: 1.  $C_L$  includes probe and jig capacitance.



• Waveforms – 1

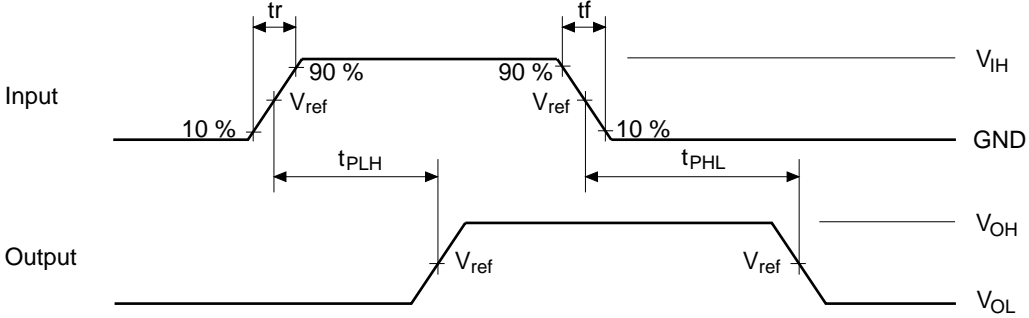

• Waveforms – 2

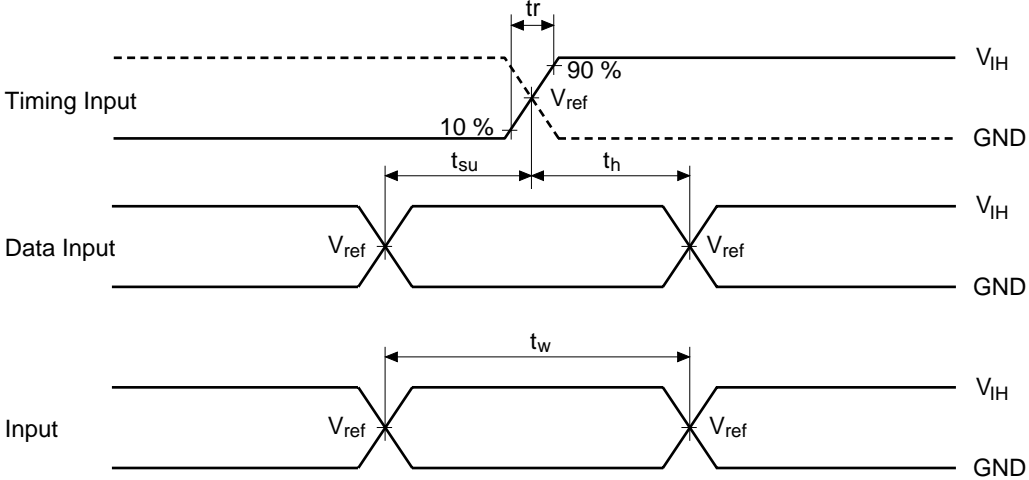

## HD74ALVCH162820

### • Waveforms – 3

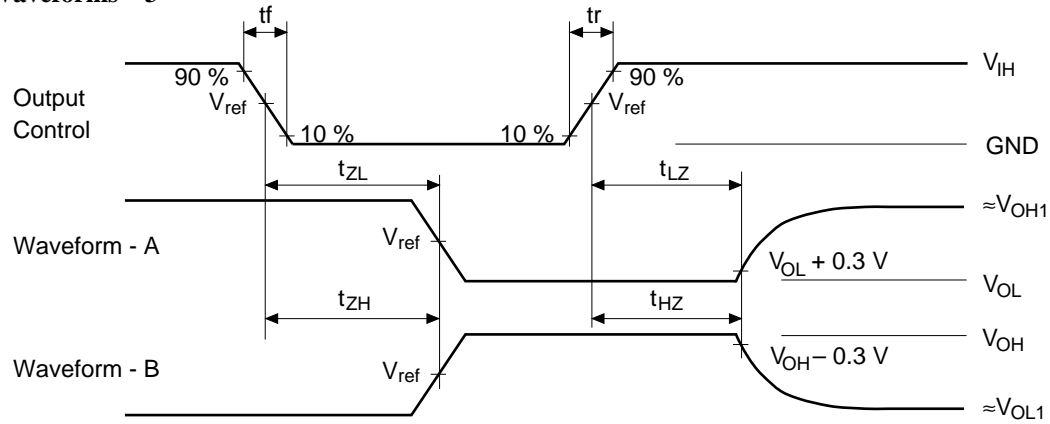

TEST	$V_{CC}=2.5\pm 0.2V$	$V_{CC}=2.7V, 3.3\pm 0.3V$
$V_{IH}$	2.3 V	2.7 V
$V_{ref}$	1.2 V	1.5 V
$V_{OH1}$	2.3 V	3.0 V
$V_{OL1}$	GND	GND

- Notes:
1. All input pulses are supplied by generators having the following characteristics:  
 $PRR \leq 10 \text{ MHz}$ ,  $Z_o = 50 \Omega$ ,  $t_r \leq 2.5 \text{ ns}$ ,  $t_f \leq 2.5 \text{ ns}$ .
  2. Waveform – A is for an output with internal conditions such that the output is low except when disabled by the output control.
  3. Waveform – B is for an output with internal conditions such that the output is high except when disabled by the output control.
  4. The output are measured one at a time with one transition per measurement.

Package Dimensions

Unit : mm

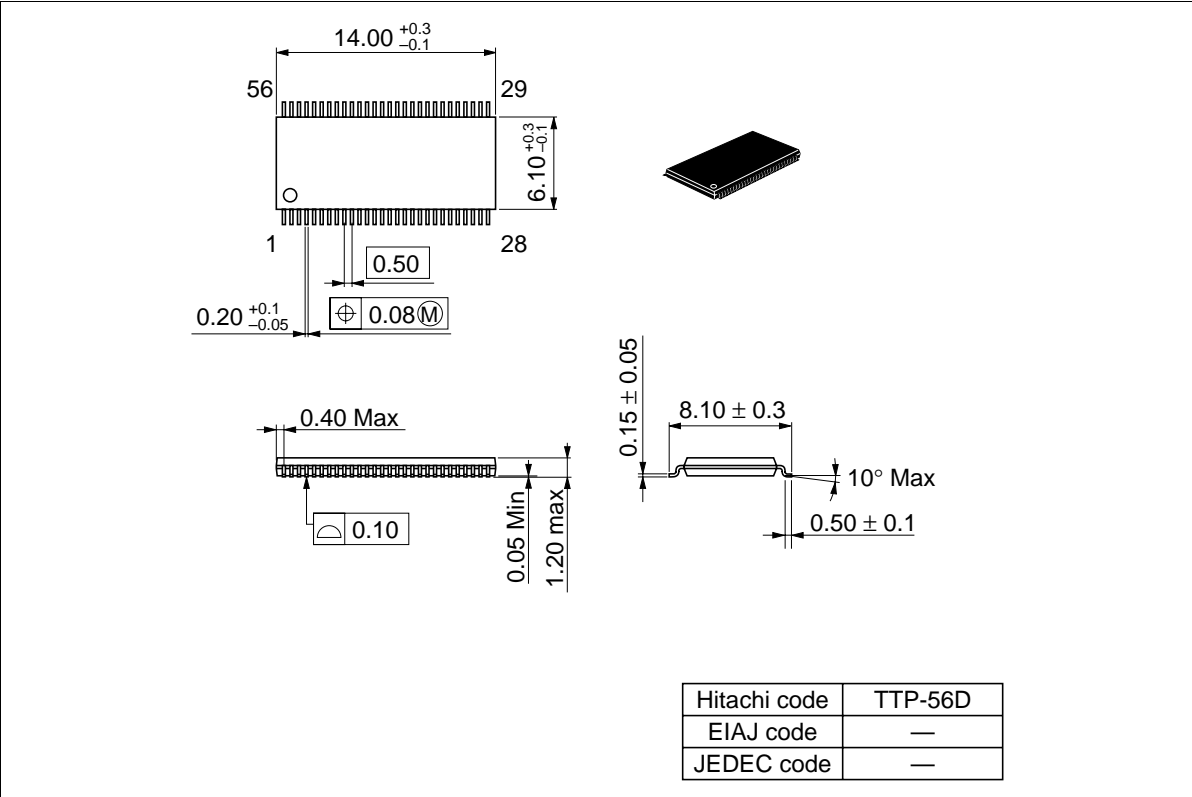

---

## HD74ALVCH162820

---

### Cautions

1. Hitachi neither warrants nor grants licenses of any rights of Hitachi's or any third party's patent, copyright, trademark, or other intellectual property rights for information contained in this document. Hitachi bears no responsibility for problems that may arise with third party's rights, including intellectual property rights, in connection with use of the information contained in this document.
2. Products and product specifications may be subject to change without notice. Confirm that you have received the latest product standards or specifications before final design, purchase or use.
3. Hitachi makes every attempt to ensure that its products are of high quality and reliability. However, contact Hitachi's sales office before using the product in an application that demands especially high quality and reliability or where its failure or malfunction may directly threaten human life or cause risk of bodily injury, such as aerospace, aeronautics, nuclear power, combustion control, transportation, traffic, safety equipment or medical equipment for life support.
4. Design your application so that the product is used within the ranges guaranteed by Hitachi particularly for maximum rating, operating supply voltage range, heat radiation characteristics, installation conditions and other characteristics. Hitachi bears no responsibility for failure or damage when used beyond the guaranteed ranges. Even within the guaranteed ranges, consider normally foreseeable failure rates or failure modes in semiconductor devices and employ systemic measures such as fail-safes, so that the equipment incorporating Hitachi product does not cause bodily injury, fire or other consequential damage due to operation of the Hitachi product.
5. This product is not designed to be radiation resistant.
6. No one is permitted to reproduce or duplicate, in any form, the whole or part of this document without written approval from Hitachi.
7. Contact Hitachi's sales office for any questions regarding this document or Hitachi semiconductor products.

---

---

# HITACHI

## Hitachi, Ltd.

Semiconductor & Integrated Circuits.  
Nippon Bldg., 2-6-2, Ohte-machi, Chiyoda-ku, Tokyo 100-0004, Japan  
Tel: Tokyo (03) 3270-2111 Fax: (03) 3270-5109

URL      NorthAmerica      : <http://semiconductor.hitachi.com/>  
             Europe                : <http://www.hitachi-eu.com/hel/ecg>  
             Asia (Singapore)      : <http://www.has.hitachi.com.sg/grp3/sicd/index.htm>  
             Asia (Taiwan)         : [http://www.hitachi.com.tw/E/Product/SICD\\_Frame.htm](http://www.hitachi.com.tw/E/Product/SICD_Frame.htm)  
             Asia (HongKong)      : <http://www.hitachi.com.hk/eng/bo/grp3/index.htm>  
             Japan                    : <http://www.hitachi.co.jp/Sicd/index.htm>

### For further information write to:

Hitachi Semiconductor  
(America) Inc.  
179 East Tasman Drive,  
San Jose, CA 95134  
Tel: <1> (408) 433-1990  
Fax: <1> (408) 433-0223

Hitachi Europe GmbH  
Electronic components Group  
Dornacher StraÙe 3  
D-85622 Feldkirchen, Munich  
Germany  
Tel: <49> (89) 9 9180-0  
Fax: <49> (89) 9 29 30 00

Hitachi Europe Ltd.  
Electronic Components Group.  
Whitebrook Park  
Lower Cookham Road  
Maidenhead  
Berkshire SL6 8YA, United Kingdom  
Tel: <44> (1628) 585000  
Fax: <44> (1628) 778322

Hitachi Asia Pte. Ltd.  
16 Collyer Quay #20-00  
Hitachi Tower  
Singapore 049318  
Tel: 535-2100  
Fax: 535-1533

Hitachi Asia Ltd.  
Taipei Branch Office  
3F, Hung Kuo Building, No.167,  
Tun-Hwa North Road, Taipei (105)  
Tel: <886> (2) 2718-3666  
Fax: <886> (2) 2718-8180

Hitachi Asia (Hong Kong) Ltd.  
Group III (Electronic Components)  
7/F., North Tower, World Finance Centre,  
Harbour City, Canton Road, Tsim Sha Tsui,  
Kowloon, Hong Kong  
Tel: <852> (2) 735 9218  
Fax: <852> (2) 730 0281  
Telex: 40815 HITEC HX

Copyright ' Hitachi, Ltd., 1999. All rights reserved. Printed in Japan.

**HITACHI**