HA12173 Series

Audio Signal Processor for Car Deck and Cassette Deck
(Dolby B/C-type NR with PB Amp)

HITACHI

ADE-204-016

1st Edition
Nov. 1992

Description

HA12173 series are silicon monolithic bipolar IC providing Dolby noise reduction system*, music sensor and PB equalizer system in one chip.

Functions

- PB equalizer × 2 channel
- Dolby B/C-NR × 2 channel
- Music sensor × 1 channel

Features

- Different type of PB equalizer characteristics selection (normal/chrome or metal) is available with fully electronic control switching built-in.
- 2 type of input selection (RADIO/TAPE) is available.
- Changeable to Forward, Reverse-mode for PB head with fully electronic control switching built-in.
- Available to change music sensing level by external resistor.
- Music sensing level selection is available with fully electronic control switching built-in.
- Available to change frequency response of music sensor.
- NR-ON/OFF and REC/PB fully electronic control switching built-in.
- 4 type of PB-out level.
- Available to allow common PCB designs with HA12163 series.

* Dolby is a trademark of Dolby Laboratories Licensing Corporation.
 A license from Dolby Laboratories Licensing Corporation is required for the use of this IC.

HA12173 Series

Ordering Information

Products	PB-OUT level	REC-OUT level	Dolby-level	Operating voltage range*1	
				Min	Max
HA12173	300 mVrms	300 mVrms	300 mVrms	7.0V	16V
HA12174	450 mVrms	300 mVrms	300 mVrms	8.0V	16V
HA12175	580 mVrms	300 mVrms	300 mVrms	9.5V	16V
HA12177	775 mVrms	300 mVrms	300 mVrms	12.0V	16V

Note: 1. The minimum operating voltage of HA12173 series are different from the HA12163 series (Dolby B - type).

Pin Description ($V_{CC} = 9\text{ V}$ Single supply, $T_a = 25^\circ\text{C}$, No signal, The value in the table show typical value)

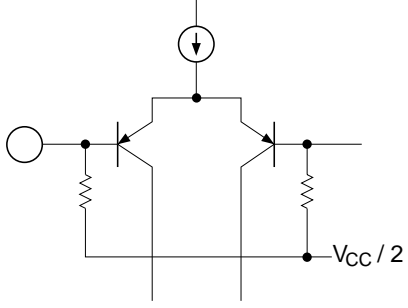
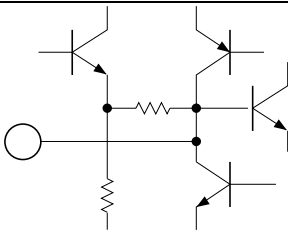
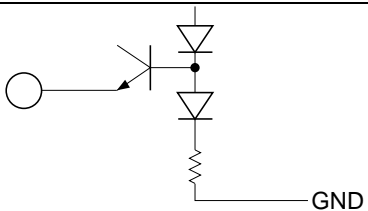
Pin No.	Terminal name	Zin	DC voltage	Equivalent circuit	Description
2, 41	TAI	100 k Ω	$V_{CC}/2$		Tape input
4, 39	RAI				Radio input
25	MSI				Music sensor rectifier input
10, 33	HLS DET	—	2.5 V		Time constant pin for rectifier
11, 32	LLS DET				
3	BIAS	—	0.28 V		Reference current input

Pin Description ($V_{CC} = 9\text{ V}$ Single supply, $T_a = 25^\circ\text{C}$, No signal, The value in the table show typical value) (cont)

Pin No.	Terminal name	Zin	DC voltage	Equivalent circuit	Description
24	MS DET	—	V_{CC}		Time constant pin for rectifier
19	MS GV	100 k Ω	—		Mode control input
40	RIP	—	$V_{CC}/2$		Ripple filter

HA12173 Series

Pin Description ($V_{CC} = 9\text{ V}$ Single supply, $T_a = 25^\circ\text{C}$, No signal, The value in the table show typical value) (cont)

Pin No.	Terminal name	Zin	DC voltage	Equivalent circuit	Description
43, 56	EQ OUT	—	$V_{CC}/2$		Equalizer output
6, 37	PB OUT				Play back (Decode) output
30	MS V_{REF}				Reference voltage buffer output
26	MA OUT				Music sensor amp output
47, 52	V_{REF}				Reference voltage buffer output
12, 31	REC OUT				Recording (Encode) output
8, 35	SS2				Spectral skewing amp. output
44, 55	EQ OUT-M	—	$V_{CC}/2$		Equalizer output (Metal)

Pin Description ($V_{cc} = 9\text{ V}$ Single supply, $T_a = 25^\circ\text{C}$, No signal, The value in the table show typical value) (cont)

Pin No.	Terminal name	Zin	DC voltage	Equivalent circuit	Description
21	MS OUT	—	—		Music sensor output to MPU
22	V_{cc}	—	V_{cc}	—	Power supply
23	MS V_{cc}	—	—	—	—
20	D GND	—	0V	—	Digital (Logic) ground
27	MS GND	—	—	—	Music sensor ground
49, 50	GND	—	—	—	Ground
48, 51	FIN	—	$V_{cc}/2$		PB - EQ input for forward
46, 53	RIN	—	—	—	PB - EQ input for reverse
45, 54	NFI	—	—	—	Negative feedback terminal of PB - EQ amp.
28	NOI	—	—	—	Negative feedback input for normal speed
29	FFI	—	—	—	Negative feedback input for FF or REW

HA12173 Series

Pin Description ($V_{cc} = 9\text{ V}$ Single supply, $T_a = 25^\circ\text{C}$, No signal, The value in the table show typical value) (cont)

Pin No.	Terminal name	Zin	DC voltage	Equivalent circuit	Description
13	C/B	100 k Ω	—		Mode control input
14	ON/OFF				
15	REC/PB				
16	TAPE/RADIO				
17	120 μ /170 μ				
18	F/R				
7, 36	SS1	—	$V_{cc}/2$		Spectral skewing amp. input
9, 34	CCR	—	$V_{cc}/2$		Current controlled resistor output
1, 5, 38, 42	NC				No connection

Block Diagram

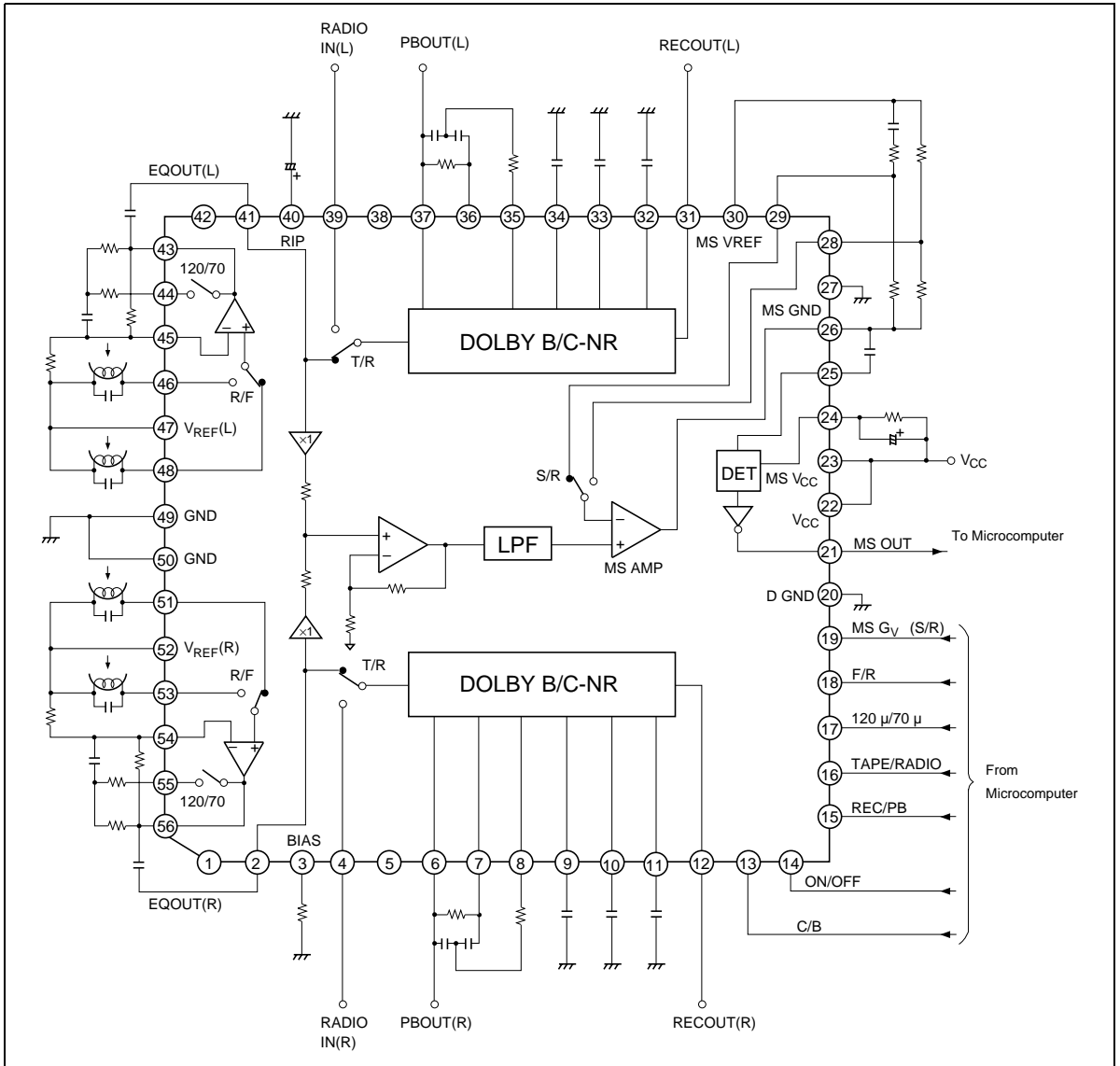

Absolute Maximum Ratings

Item	Symbol	Ratings	Unit	Condition
Supply voltage	V_{cc} max	16	V	
Power dissipation	P_T	500	mW	$T_a \leq 85^\circ\text{C}$
Operating temperature	T_{opr}	-40 to +85	$^\circ\text{C}$	
Storage temperature	T_{stg}	-55 to +125	$^\circ\text{C}$	

HA12173 Series

Electrical Characteristics (Ta = 25°C Dolby level 300 mVrms (Rec-out pin))

HA12173 V_{cc} = 9.0 V HA12174 V_{cc} = 9.0 V
 HA12175 V_{cc} = 12.0 V HA12177 V_{cc} = 14.0 V

Item	Symbol	Min	Typ	Max	Unit	Test Condition	Note
Quiescent current	I _Q	10.0	16.0	24.0	mA	No input	No Signal NR-B70 μ
Input Amp. gain	HA12173	GvIA TAI	18.5	20.0	21.5	dB	Vin = 0 dB, f = 1 kHz
		GvIA RAI	15.5	17.0	18.5		
	HA12174	GvIA TAI	22.0	23.5	25.0		Vin = 0 dB, f = 1 kHz
		GvIA RAI	19.0	20.5	22.0		
	HA12175	GvIA TAI	24.2	25.7	27.2		Vin = 0 dB, f = 1 kHz
		GvIA RAI	21.2	22.7	24.2		
	HA12177	GvIA TAI	26.7	28.2	29.7		Vin = 0 dB, f = 1 kHz
		GvIA RAI	23.7	25.2	26.7		
B-type Encode boost	ENC -2k	2.8	4.3	5.8	dB	Vin = -20 dB, f = 2 kHz	
	ENC -5k	1.7	3.2	4.7		Vin = -20 dB, f = 5 kHz	
C-type Encode boost	ENC -1k (1)	3.9	5.9	7.9	dB	Vin = -20 dB, f = 1 kHz	
	ENC -1k (2)	18.1	19.6	21.6		Vin = -60 dB, f = 1 kHz	
	ENC -700	9.8	11.8	13.8		Vin = -30 dB, f = 700 Hz	
Signal handling	Vo max	12.0	13.0	—	dB	THD = 1%, f = 1 kHz	*1
Signal to noise ratio	S/N	60.0	64.0	—	dB	Rg = 5.1 kΩ, CCIR/ARM	
THD	THD	—	0.05	0.3	%	Vin = 0 dB, f = 1 kHz	
Channel separation	CT RL (1)	70.0	85.0	—	dB	Vin = 0 dB, f = 1 kHz	RAI input
	CT RL (2)	50.0	60.0	—		Vin = 0.6 mVrms, f = 1 kHz	EQ input
Crosstalk	CT EQ → RAI	70.0	80.0	—		Vin = 0.6 mVrms, f = 1 kHz	EQ input
	CT RAI → EQ	50.0	60.0	—		Vin = 0 dB, f = 1 kHz	RAI input
PB - EQ gain	Gv EQ 1k	37.0	40.0	43.0	dB	Vin = 0.6 mVrms, f = 1 kHz	120 μ
	Gv EQ 10k (1)	33.0	36.0	39.0		Vin = 0.6 mVrms, f = 10 kHz	
	Gv EQ 10k (2)	29.0	32.0	35.0			70 μ
PB - EQ maximum output	VoM	300	600	—	mVrms	THD = 1%, f = 1 kHz	*1
PB - EQ THD	THD - EQ	—	0.05	0.3	%	Vin = 0.6 mVrms, f = 1 kHz	
Noise voltage level converted in input	V _N	—	0.7	1.5	μVrms	Rg = 680 Ω, DIN - AUDIO	
MS sensing level	V _{ON} (1)	-36.0	-32.0	-28.0	dB	f = 5 kHz, Normal speed	
	V _{ON} (2)	-18.0	-14.0	-10.0		f = 5 kHz, High speed	

Electrical Characteristics (Ta = 25°C Dolby level 300 mVrms (Rec-out pin)) (cont)

HA12173 V_{cc} = 9.0 V HA12174 V_{cc} = 9.0 V
HA12175 V_{cc} = 12.0 V HA12177 V_{cc} = 14.0 V

Item	Symbol	Min	Typ	Max	Unit	Test Condition	Note
MS output low level	V _{OL}	—	1.0	1.5	V		
MS output leak current	I _{OH}	—	0.0	2.0	μA		
Control voltage	V _{IL}	-0.2	—	1.5	V		
	V _{IH}	3.5	—	5.3			

Note: 1. HA12173 V_{cc} = 7.0 V, HA12174 V_{cc} = 8.0 V, HA12175 V_{cc} = 9.5 V, HA12177 V_{cc} = 12.0 V

HA12173 Series

Test Circuit

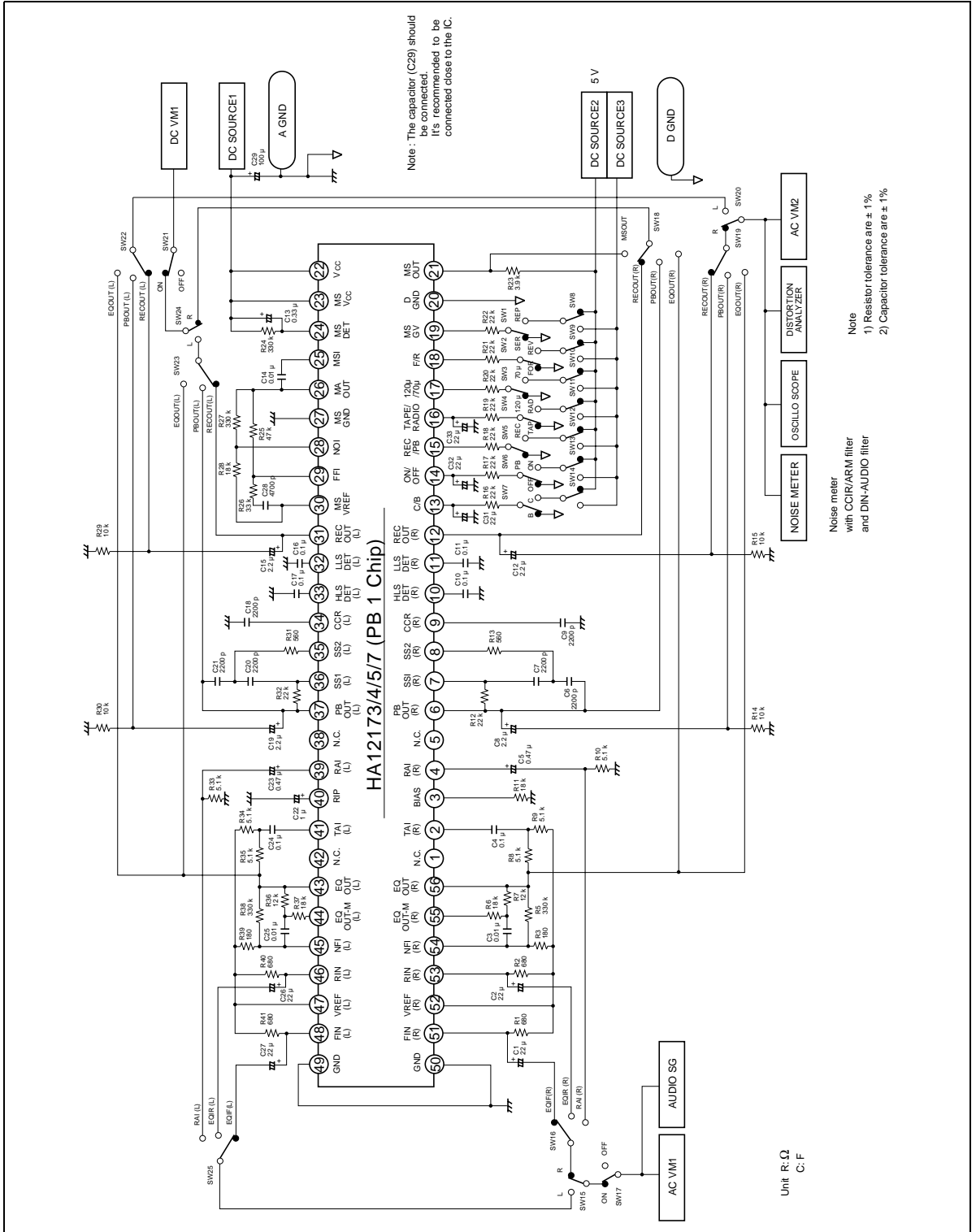

Noise meter with CCIR/ARM filter and DIN-AUDIO filter

Note
 1) Resistor tolerance are ± 1%
 2) Capacitor tolerance are ± 1%

Functional Description

Power Supply Range

HA12173 series are provided with four line output level, which will permit on optimum overload margin for power supply conditions. And this series are designed to operate on either single supply or split supply.

Table 1 Supply Voltage

Item		HA12173	HA12174	HA12175	HA12177
Single supply		7.0 V to 16.0 V	8.0 V to 16.0 V	9.5 V to 16.0 V	12.0 V to 16.0 V
Split supply	GND level	±5.0 V to 8.0 V	±5.0 V to 8.0 V	±5.0 V to 8.0 V	±6.0 V to 8.0 V
	V _{EE} level	±3.5 V to ±8.0 V	±4.0 V to 8.0 V	±4.8 V to 8.0 V	±6.0 V to 8.0 V

A. The lower limit of supply voltage depends on the line output reference level.

The minimum value of the overload margin is specified as 12 dB by Dolby Laboratories.

B. In case of using digital GND terminal referring to GND level, operating voltage range varies depending on the condition at power on. On using the HA12173/174/175, use within the following ranges to avoid latch-ups.

When power on in NR-OFF mode: ±5.0 V to ±8.0 V

When power on in NR-ON mode: ±5.7 V to ±8.0 V

C. In the reverse-voltage conditions such as 'D-GND is higher than V_{CC}' or 'D-GND is lower than GND', excessive current flows into the D-GND to destroy this IC. To prevent such destruction, pay attention to the followings on using.

Single power supply : Short-circuit the D-GND and GND directory on the board mounting this IC.

Split power supply : Avoid reverse conditions of D-GND and V_{CC} or V_{EE} voltage, including transient-time of power ON/OFF.

Reference Voltage

For the single supply operation these devices provide the reference voltage of half the supply voltage that is the signal grounds. As the peculiarity of these devices, the capacitor for the ripple filter is very small about 1/100 compared with their usual value. The Reference voltage are provided for the left channel and the right channel separately. The block diagram is shown as figure 1.

HA12173 Series

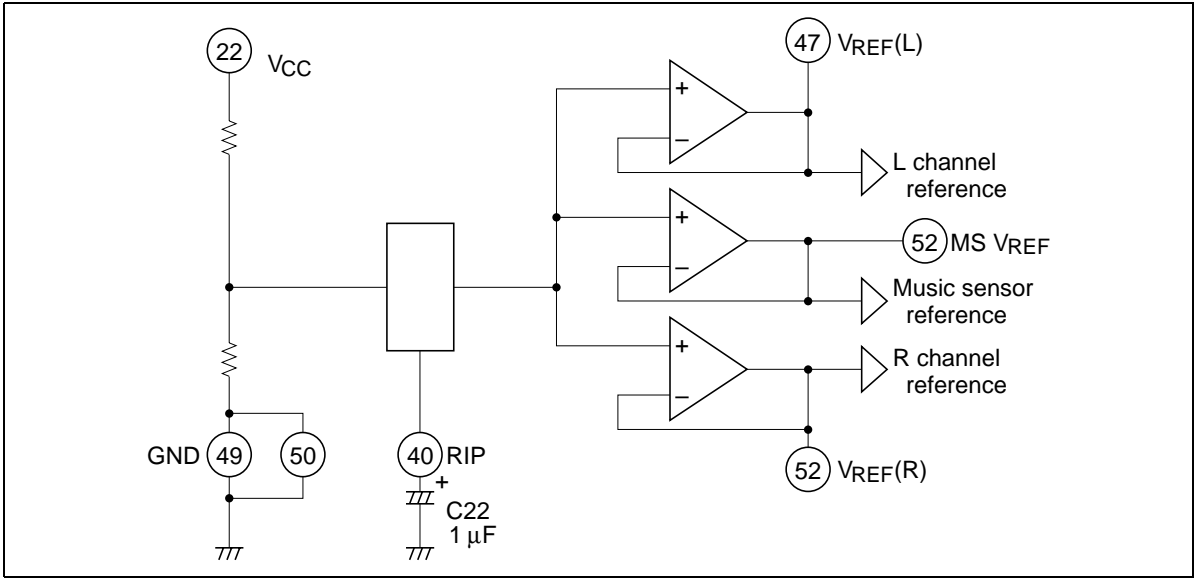

Figure 1 The Block Diagram of Reference Voltage Supply

Operating Mode Control

HA12173 series provide fully electronic switching circuits. And each operating mode control are controlled by parallel data (DC voltage).

Table 2 Threshold Voltage (V_{TH})

Pin No.	Low	High	Unit	Test condition
13, 14, 15, 16, 17, 18, 19	-0.2 to 1.5	3.5 to 5.3	V	

Table 3 Switching Truth Table

Pin No.	Low	High
13	B - NR	C - NR
14	NR - OFF	NR - ON
15	PB	REC
16	TAPE	RADIO
17	120 μ (NORMAL)	70 μ (METAL or CHROME)
18	FORWARD	REVERSE
19	SER (FF or REV)	REP (NORMAL SPEED)

Notes: 1. Voltages shown above are determined by internal circuits of LSI when take pin 20 (DGND pin) as reference pin. On split supply use, same V_{TH} can be offered by connecting DGND pin to GND pin.

This means that it can be controlled directly by microprocessor. But power supply should be over ± 5 V, notwithstanding the prescription of table 1.

2. Each pins are on pulled down with 100 k Ω internal resistor. Therefore, it will be low-level when each pins are open.
3. Over shoot level and under shoot level of input signal must be the standardized (High: 5.3 V, Low: -0.2 V)
4. When connecting microcomputer or Logic-IC with HA12173 series directly, there is apprehension of rush-current under some transition timing of raising voltage or falling voltage at V_{CC} ON/OFF. On using, connect protective resistors of 10 to 22 k Ω to all the control pins. It is shown is test circuit on this data sheet. And pins fixed to low level should be preferably open.
5. Pay attention not to make digital GND voltage lower than GND voltage.

HA12173 Series

Input Block Diagram and Level Diagram

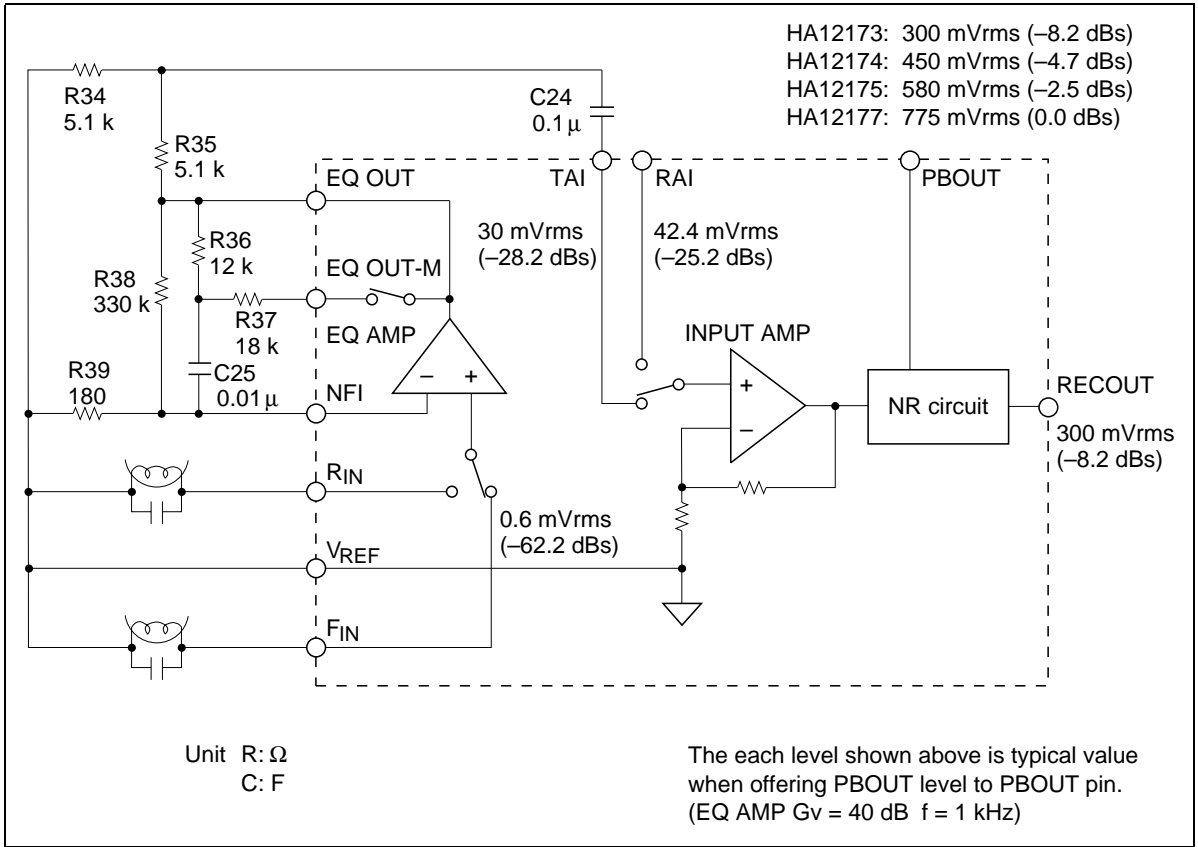

Figure 2 Input Block Diagram

Adjustment of Playback Dolby Level

After replace R34 and R35 with a half-fix volume of 10 k Ω , adjust RECOUT level to be Dolby level with playback mode.

Note on Connecting with Tape Head to IC

This IC has no internal resistor to give the DC bias current to equalizer amp., therefore the DC bias current will give through the head. This IC provides the Vref buffer output pin for Rch and Lch separately (has two Vref terminal). In case of use that the Rch and Lch reference of head are connected commonly, please use one of Vref terminals of IC (47 pin or 52 pin) for head reference. If both 47 pin and 52 pin of IC are connected, rush current give the great damage to IC. The application circuit is shown in figure 3.

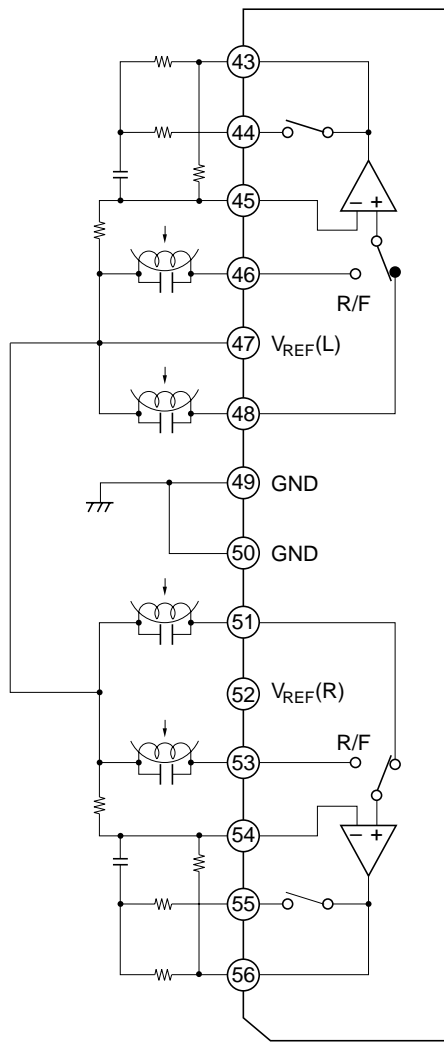

Figure 3 Application Circuit

HA12173 Series

The Sensitivity Adjustment of a Music Sensor

Adjusting MS AMP. gain by external resistor, the sensitivity of music sensor can set up.

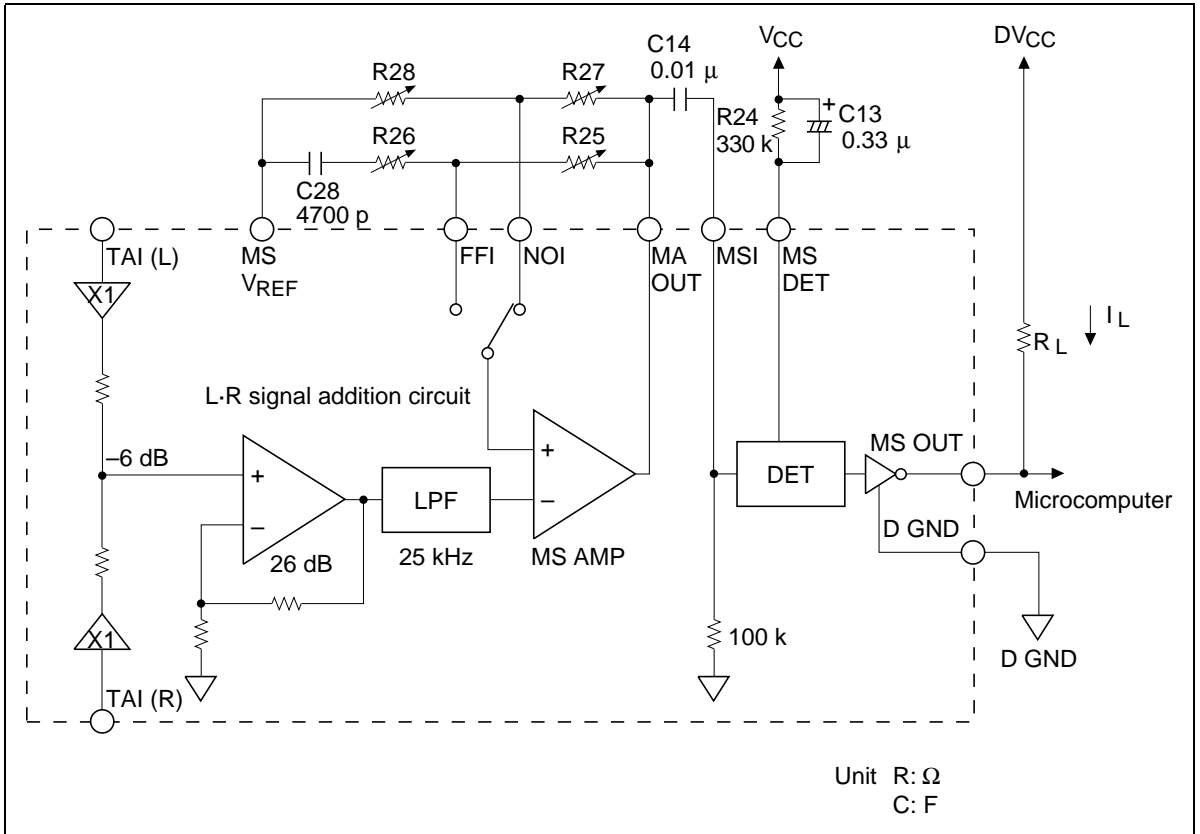

Figure 4 Music Sensor Block Diagram

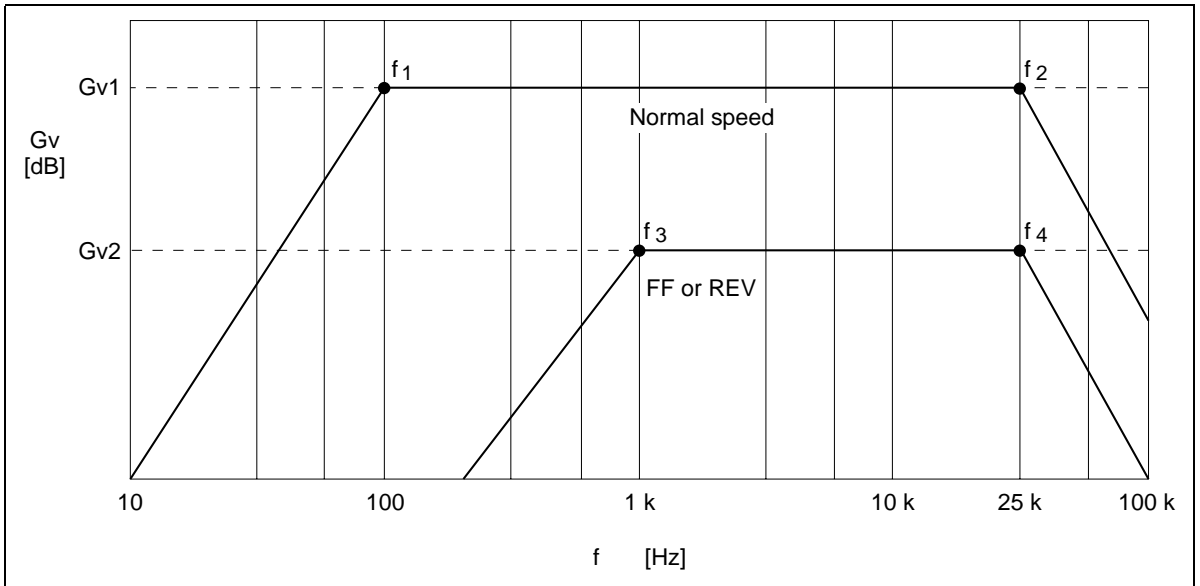

Figure 5 Frequency Response

1. Normal mode

$$Gv1 = 20 \log \left(1 + \frac{R27}{R28} \right) [\text{dB}]$$

$$f1 = \frac{1}{2 \cdot \pi \cdot C14 \cdot 100 \text{ k}} [\text{Hz}], f2 = 25 \text{ k} [\text{Hz}]$$

2. FF or REW mode

$$Gv2 = 20 \log \left(1 + \frac{R25}{R26} \right) [\text{dB}]$$

$$f3 = \frac{1}{2 \cdot \pi \cdot C28 \cdot R26} [\text{Hz}], f4 = 25 \text{ k} [\text{Hz}]$$

A standard level of TAI pin is 30 mVrms and the gain for TAI to MS AMP input is 10, therefore, the other channel sensitivity of music sensor (S) is computed by the formula mentioned below.

$$S = 20 \log \frac{C}{30} \cdot \frac{1}{10 \cdot A} [\text{dB}]$$

A = MS AMP. gain (B dB)

S = -7.3-B [dB] C = 130 mVrms (typ.)

S is 6 dB up in case of the both channels.

C = The sensing level of music sensor

HA12173 Series

Music Sensor Output (MS OUT)

As for the internal circuit of music sensor block, music sensor out pin is connected to the collector of NPN Type directly, Output level will be “high” when sensing no signal. And output level will be “low” when sensing signal.

Connection with microcomputer, design I_L at 1 mA typ.

$$I_L = \frac{DV_{CC} - MSOUT_{Lo} *}{R_L}$$

* $MSOUT_{Lo}$: Sensing signal (about 1 V)

- Notes: 1. Supply voltage of MS OUT pin must be less than V_{CC} voltage.
 2. MS V_{CC} pin and V_{CC} pin are required the same voltage.

The Tolerances of External Components for Dolby NR-block

For adequate Dolby NR tracking response, take external components shown below.

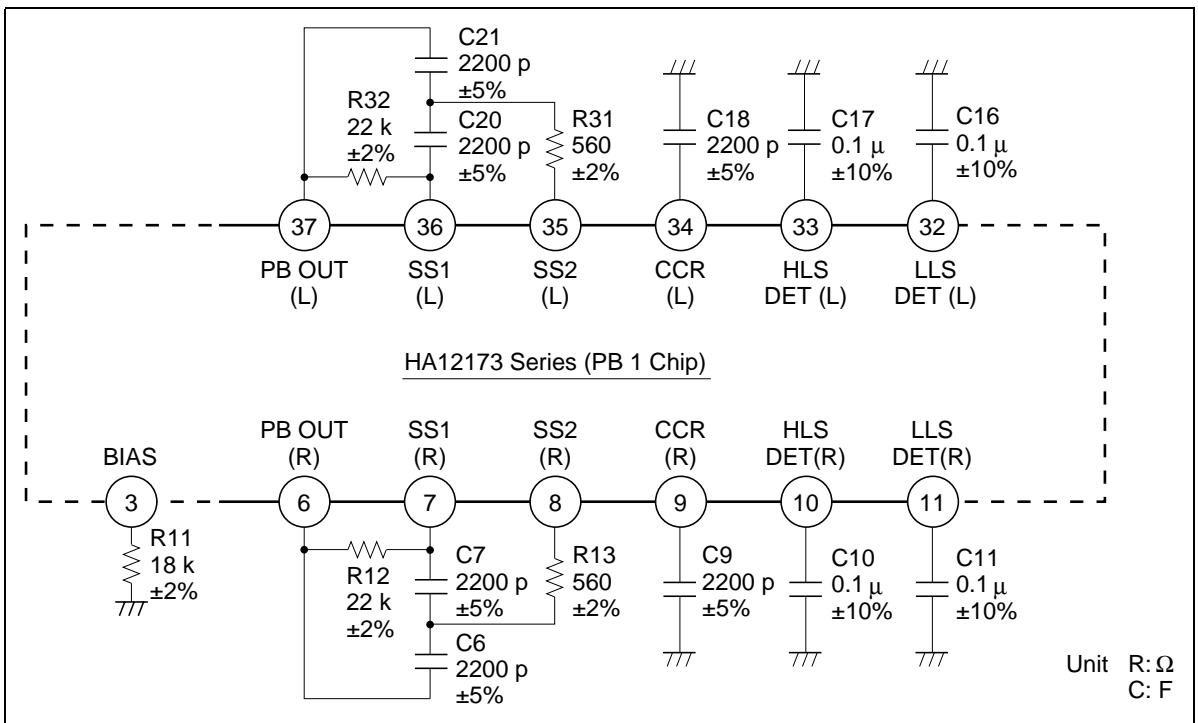

Figure 6 Tolerances of External Components

PB Equalizer for Double Speed

PB equalizer can be design for double speed by using external components shown in figure 7. Application data is shown in figure 8.

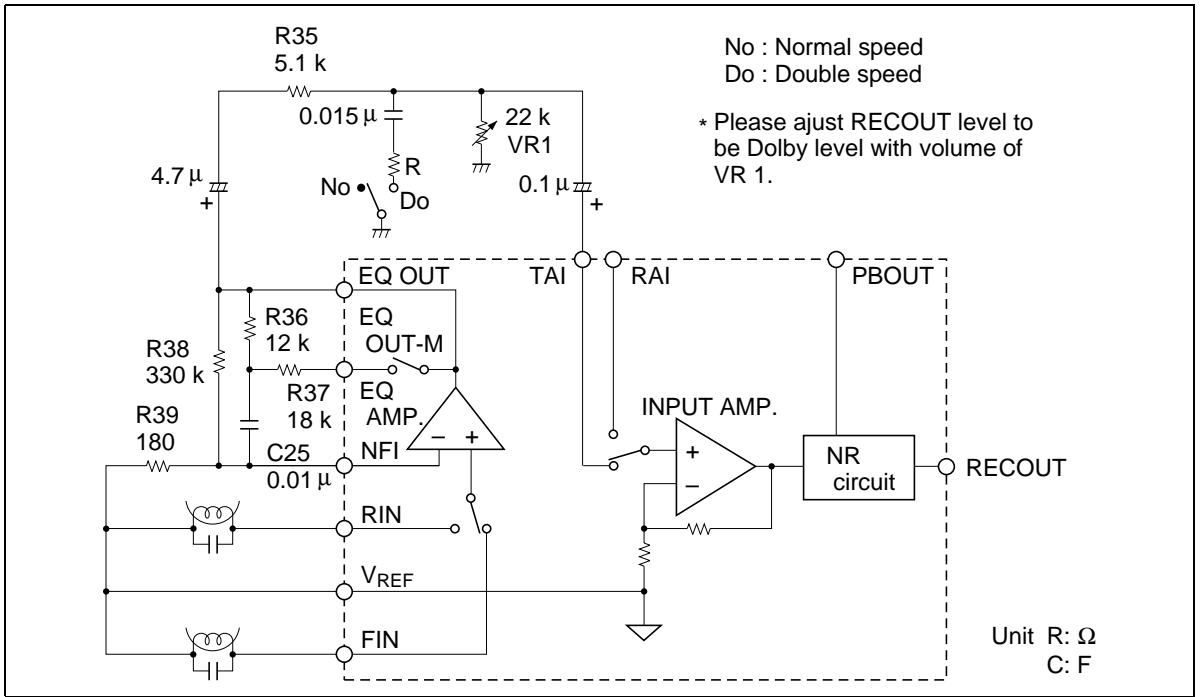

Figure 7 Application Circuit for Double Speed

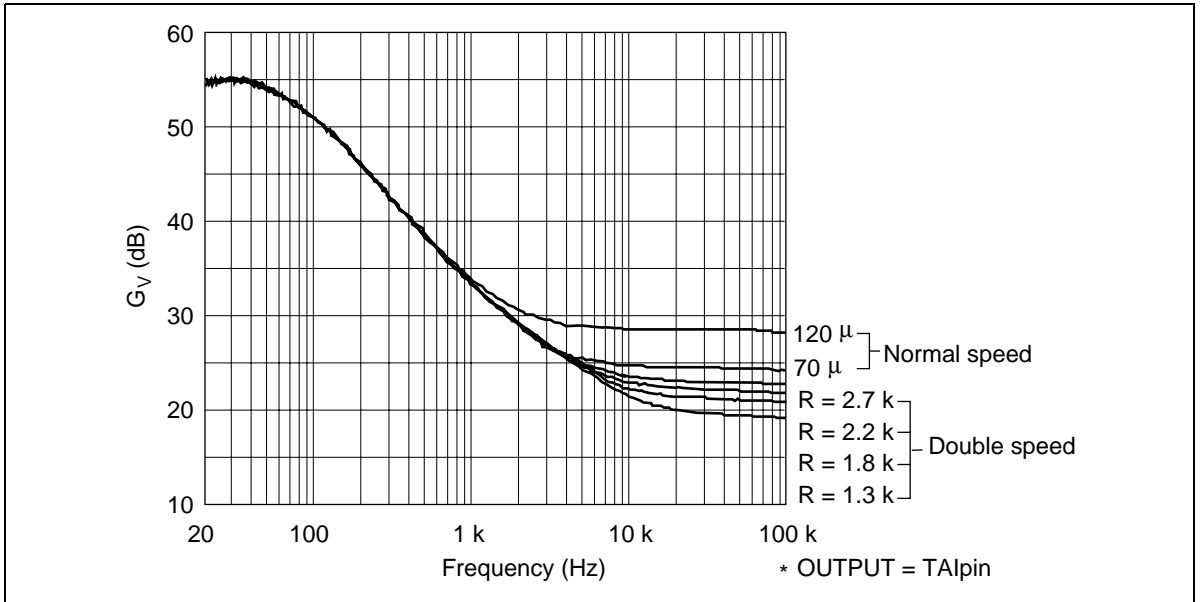
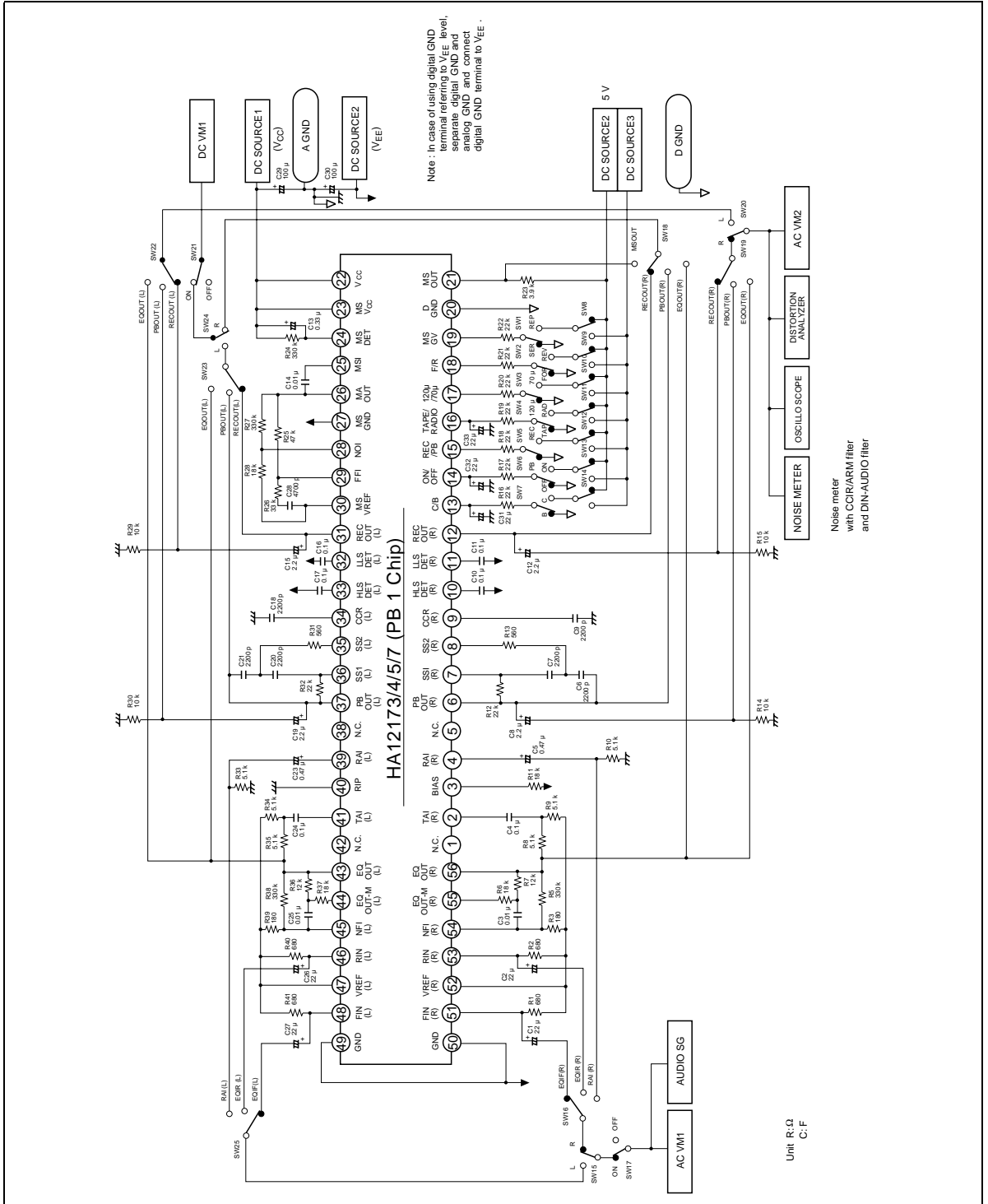

Figure 8 Application data

HA12173 Series

Circuit For Split Supply

HA12173



Typical Characteristic Curves

HA12173

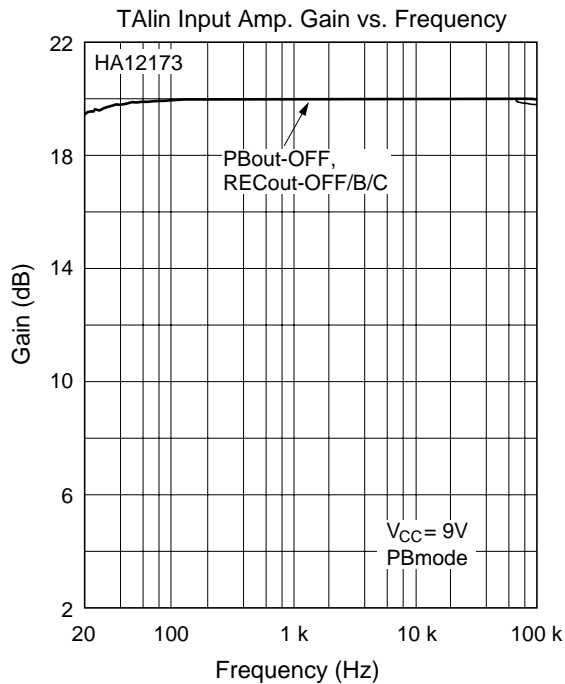
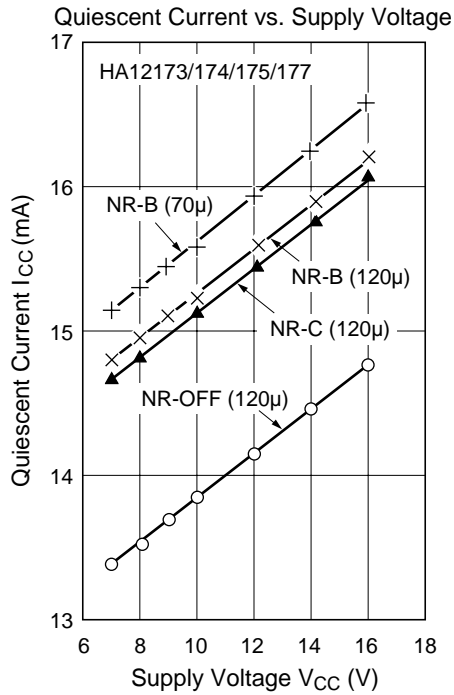

HA12173 Series

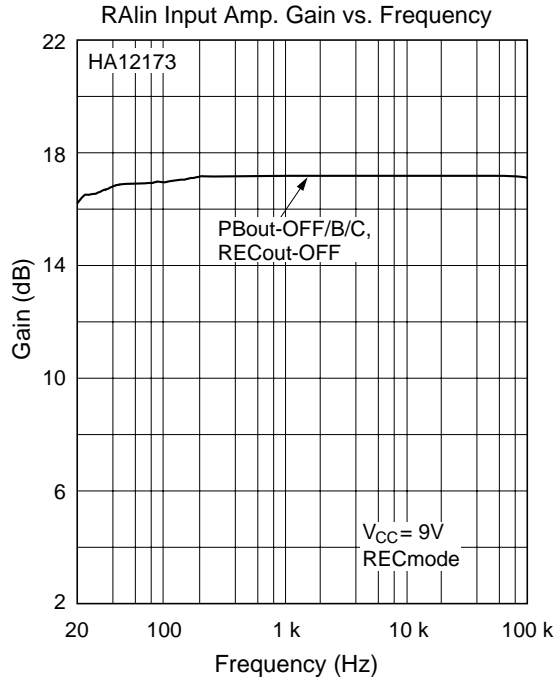

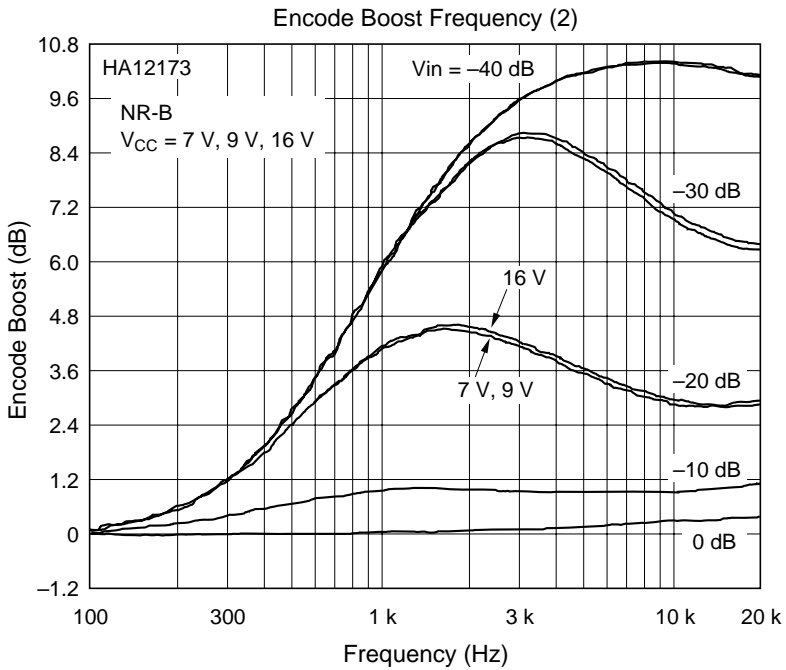
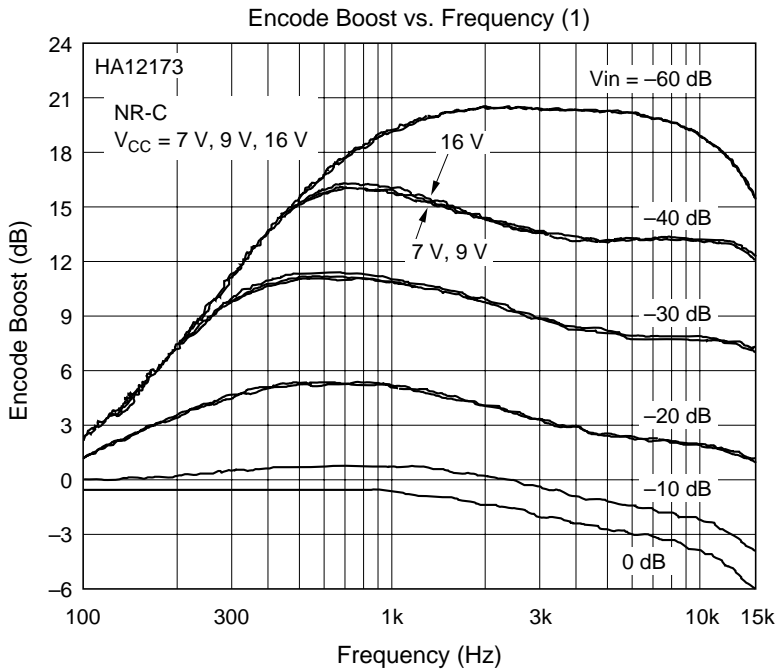

HA12173 Series

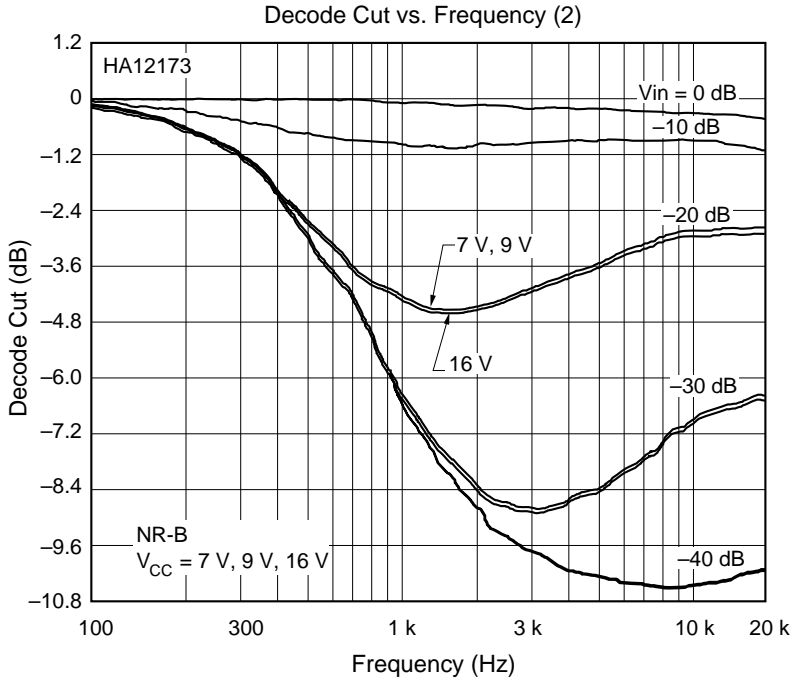
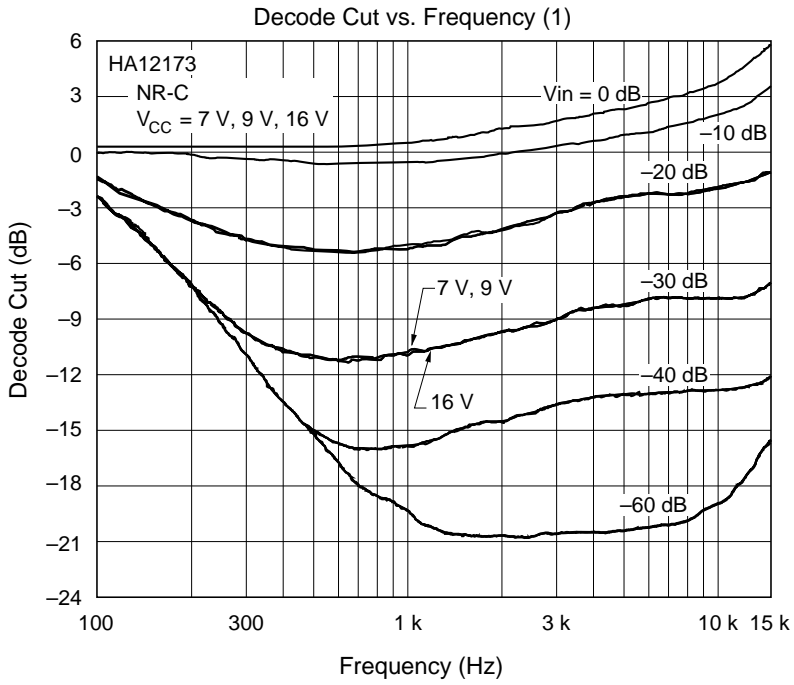

Maximum Output Level vs. Supply Voltage (1)

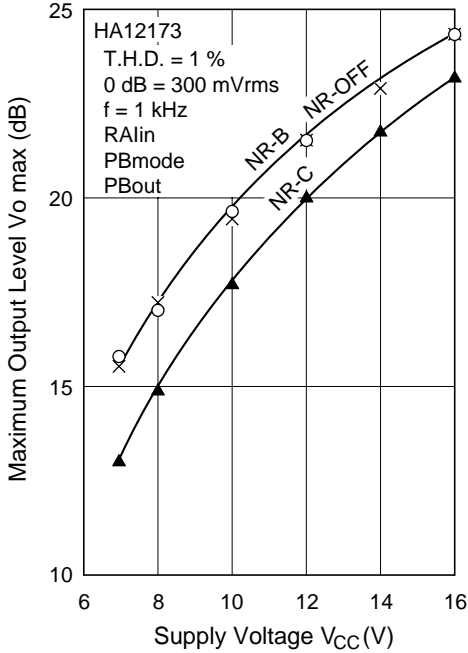

Maximum Output Level vs. Supply Voltage (2)

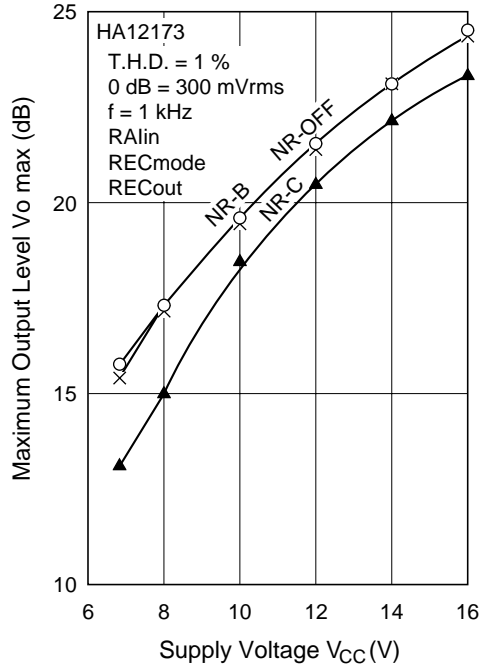

Signal to Noise Ratio vs. Supply Voltage (1)

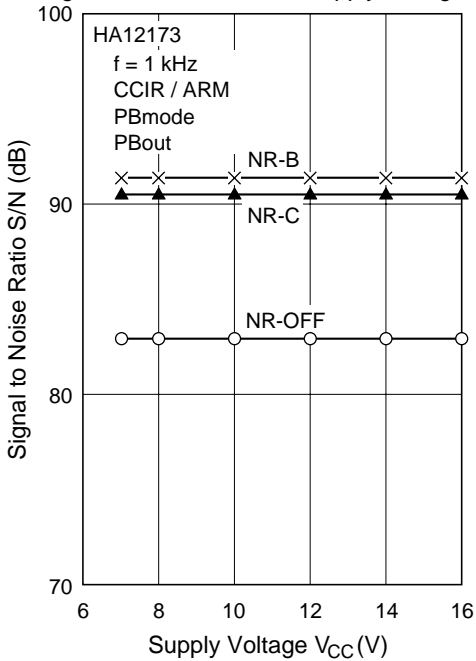

Signal to Noise Ratio vs. Supply Voltage (2)

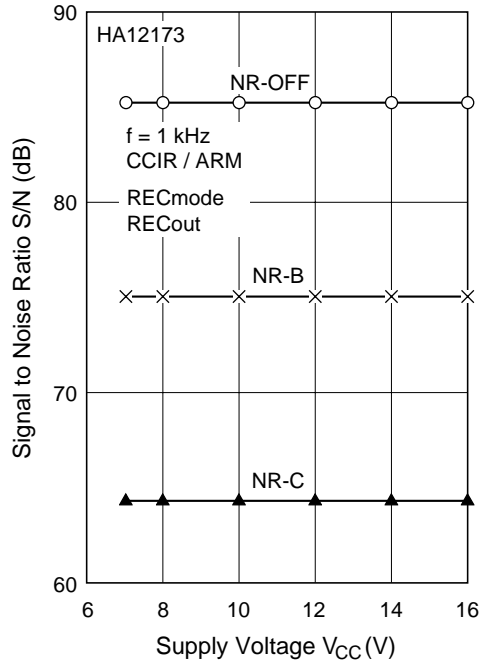

HA12173 Series

Total Harmonic Distortion vs. Supply Voltage (1)

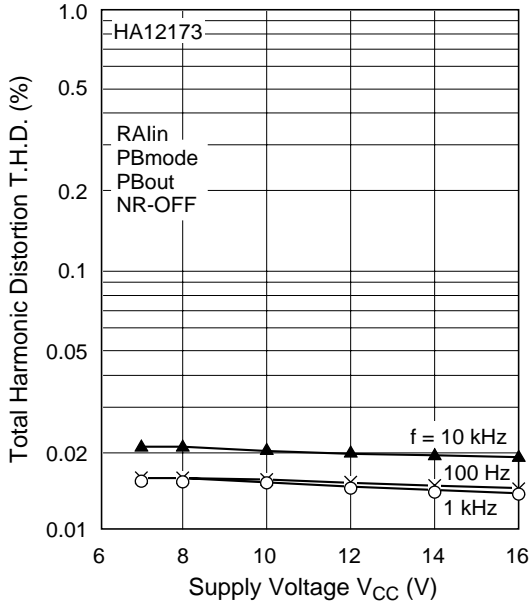

Total Harmonic Distortion vs. Supply Voltage (2)

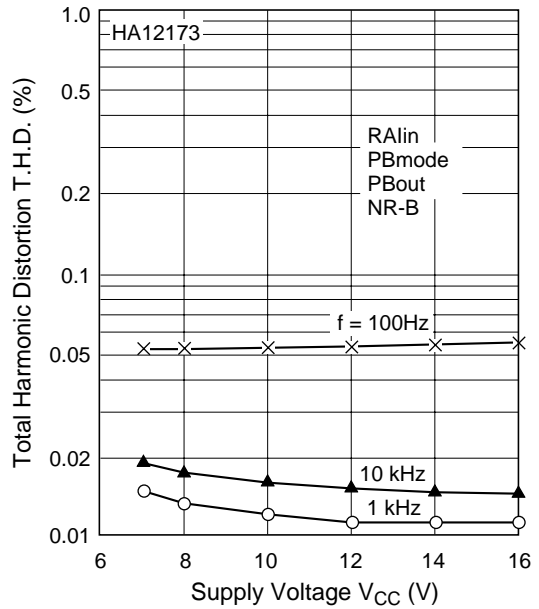

Total Harmonic Distortion vs. Supply Voltage (3)

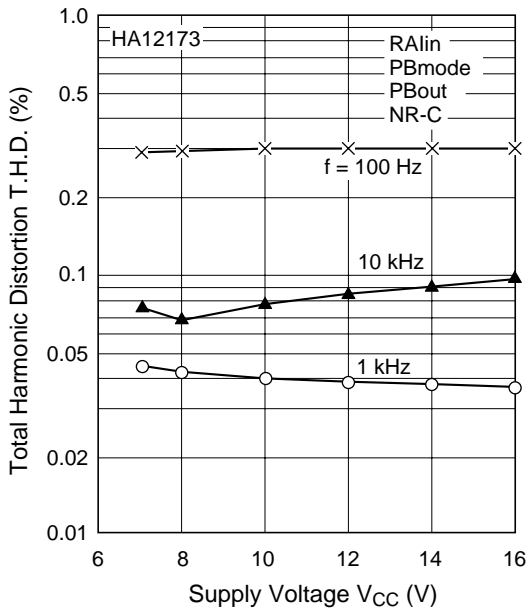

Total Harmonic Distortion vs. Supply Voltage (4)

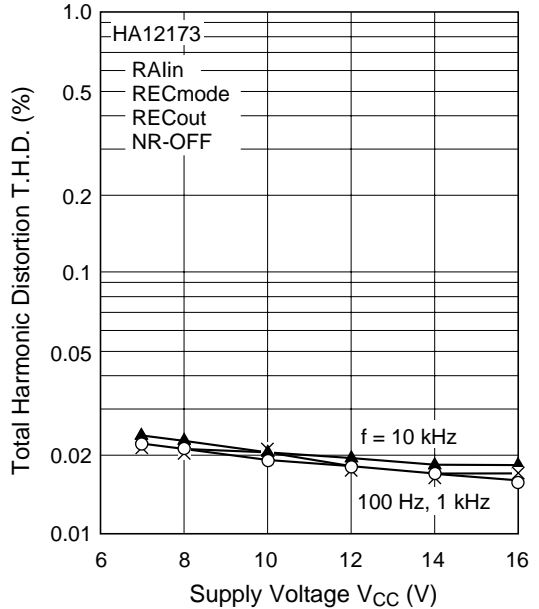

Total Harmonic Distortion vs. Supply Voltage (5)

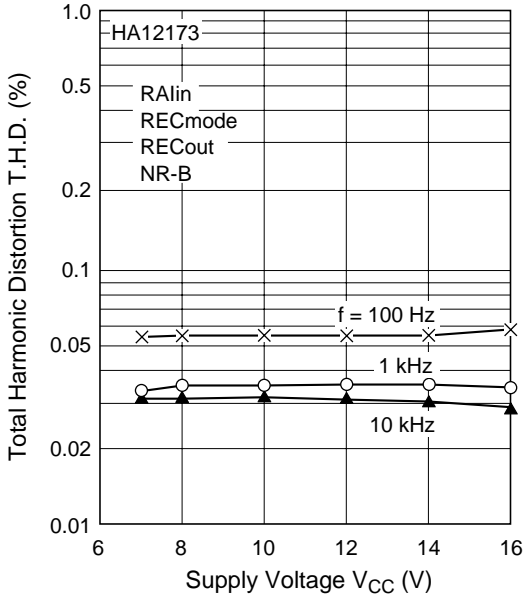

Total Harmonic Distortion vs. Supply Voltage (6)

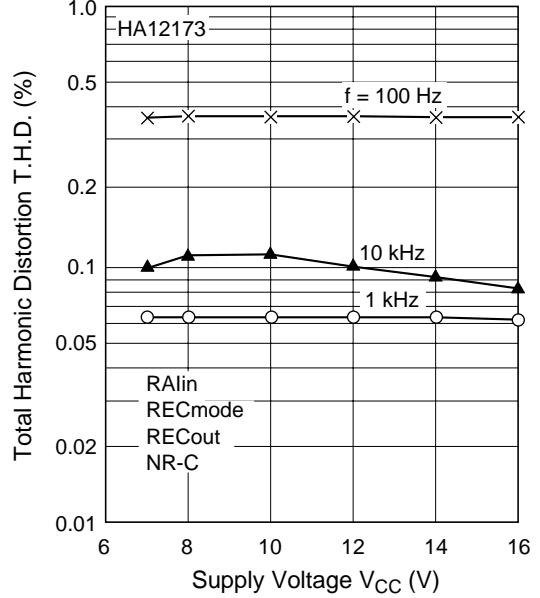

Total Harmonic Distortion vs. Output Level (1)

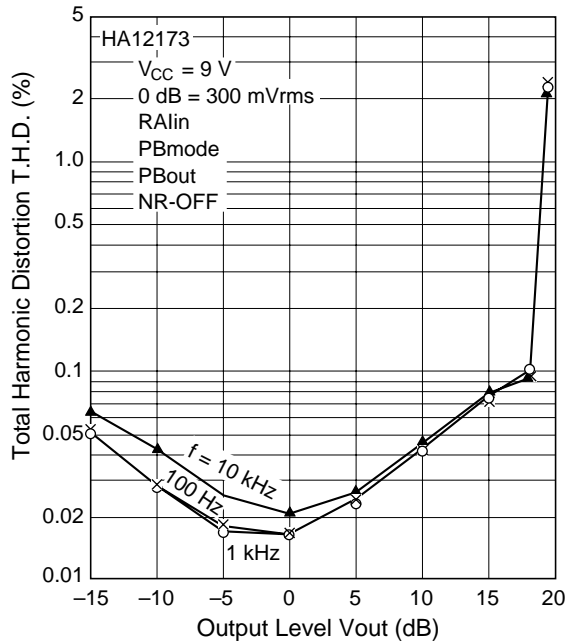

Total Harmonic Distortion vs. Output Level (2)

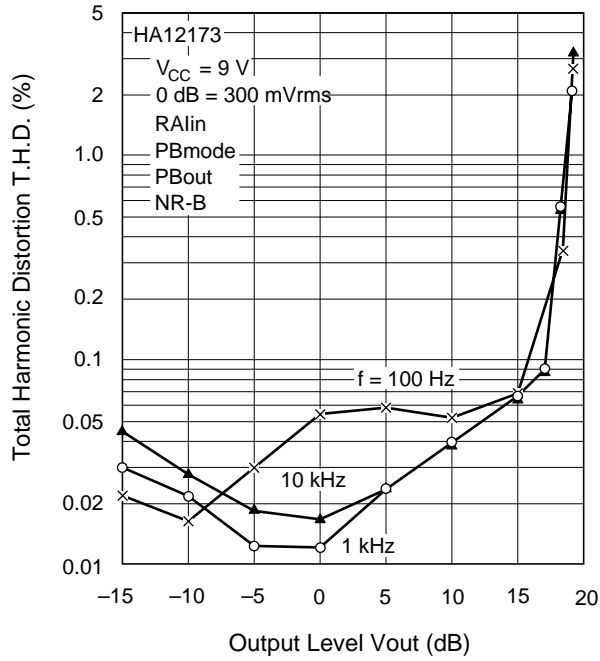

Total Harmonic Distortion vs. Output Level (3)

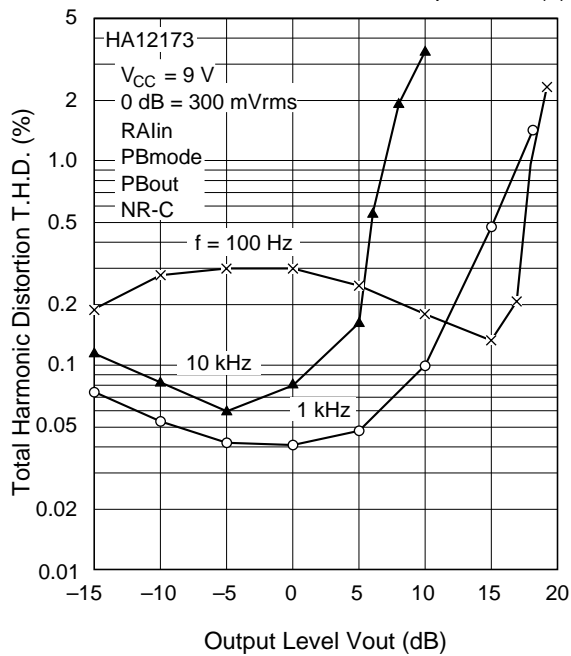

Total Harmonic Distortion vs. Output Level (4)

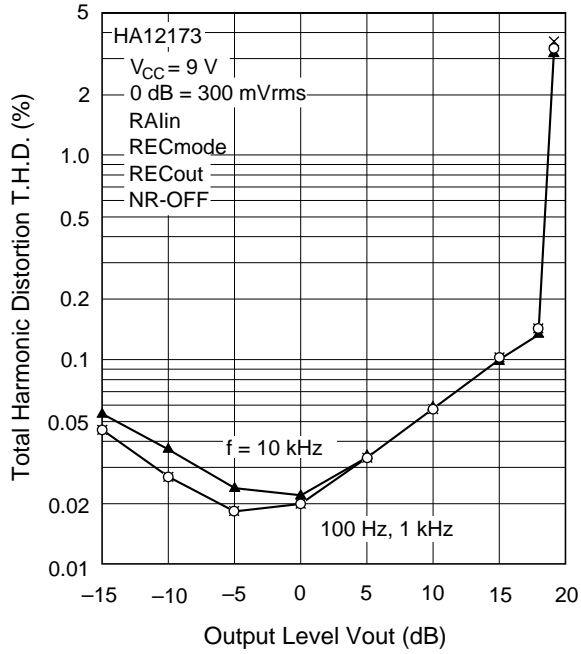

Total Harmonic Distortion vs. Output Level (5)

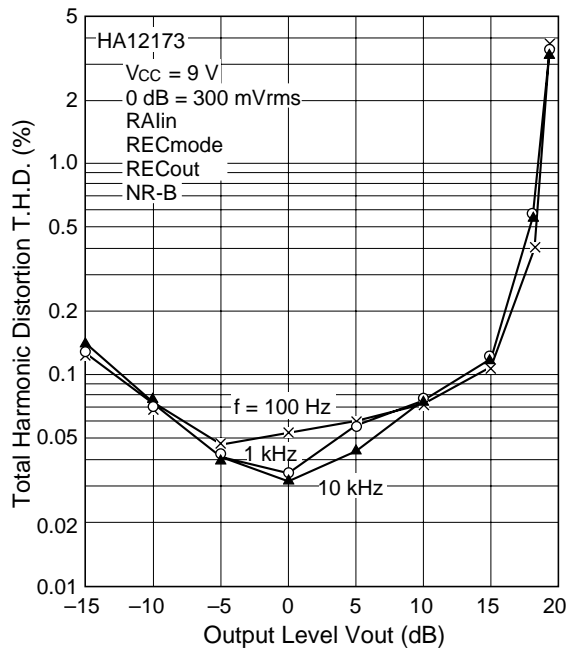

HA12173 Series

Total Harmonic Distortion vs. Output Level (6)

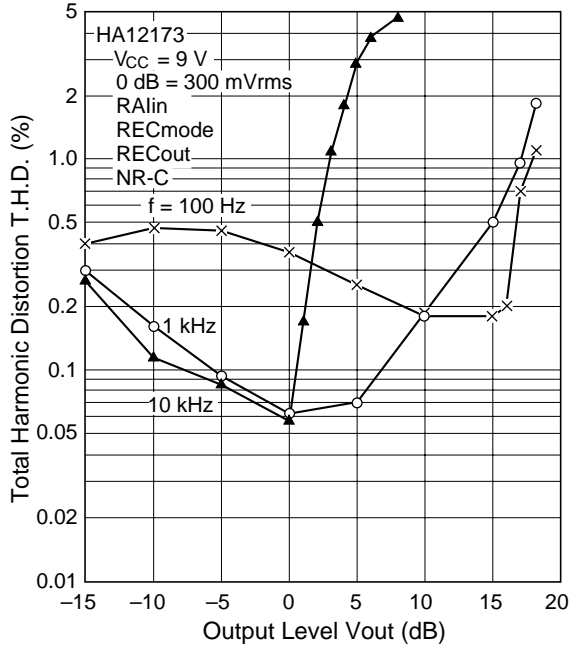

Total Harmonic Distortion vs. Frequency (1)

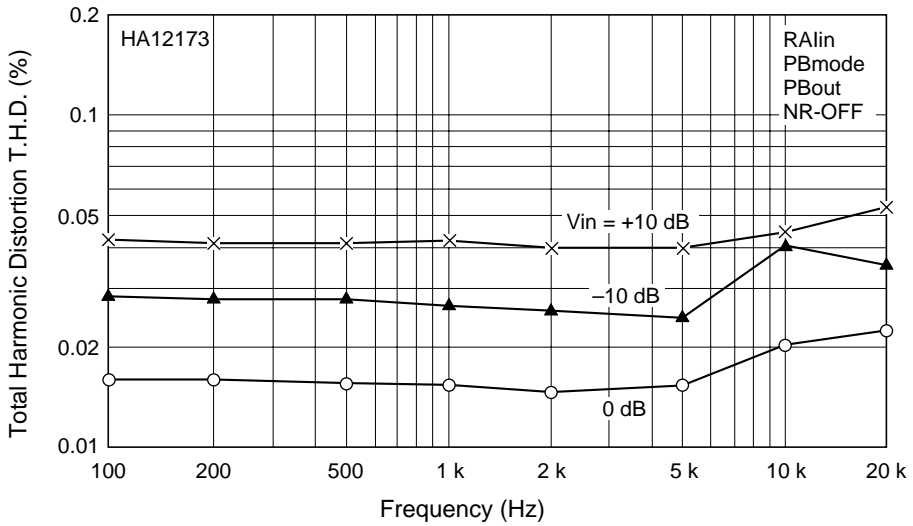

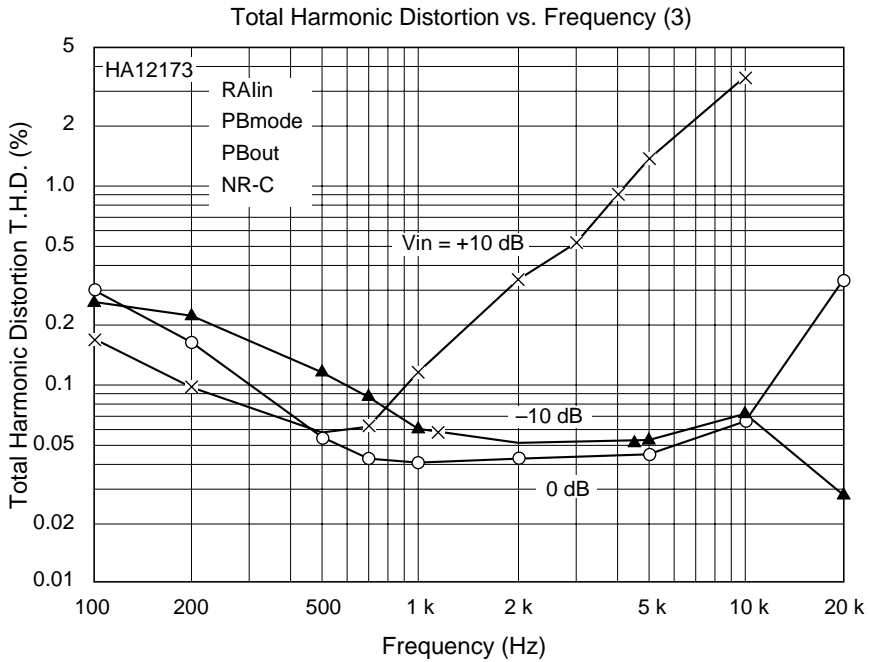
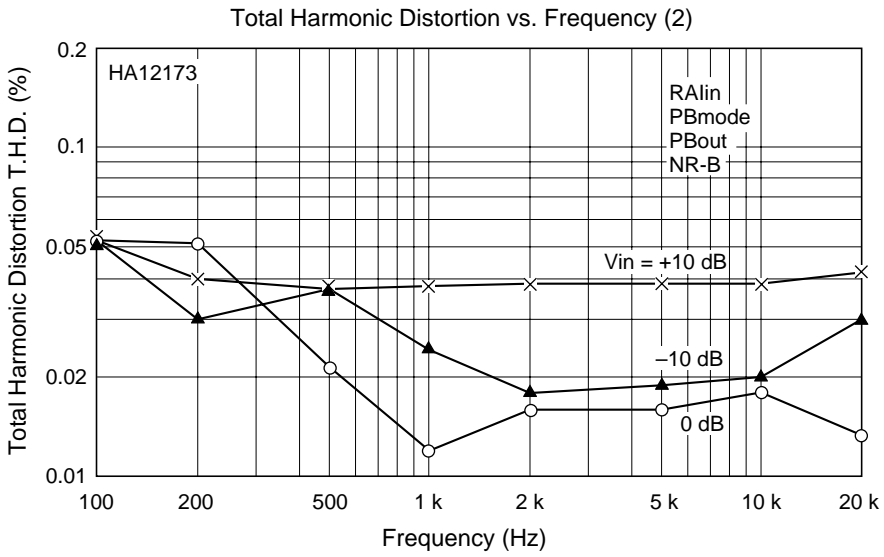

HA12173 Series

Total Harmonic Distortion vs. Frequency (4)

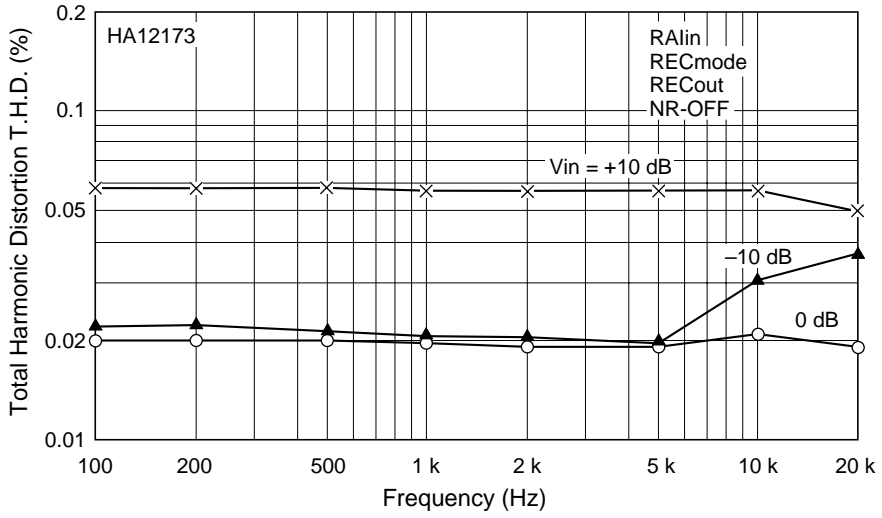

Total Harmonic Distortion vs. Frequency (5)

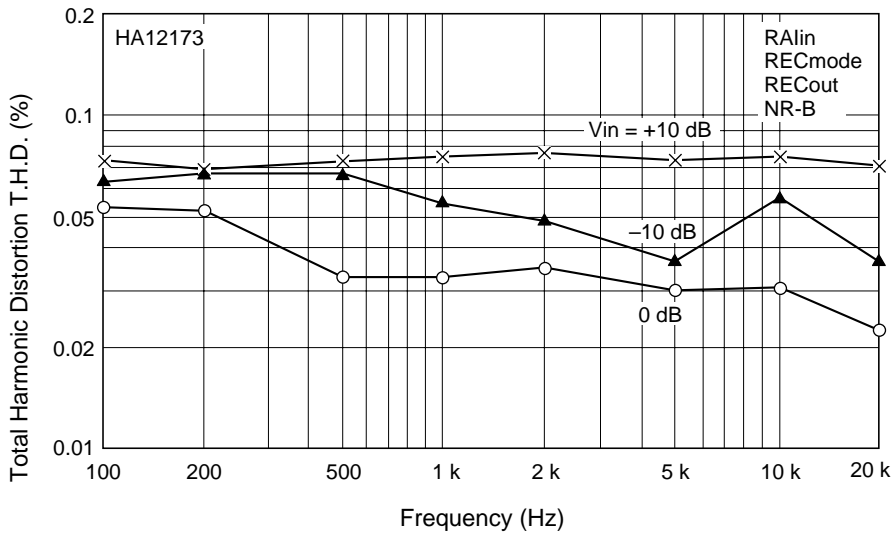

Total Harmonic Distortion vs. Frequency (6)

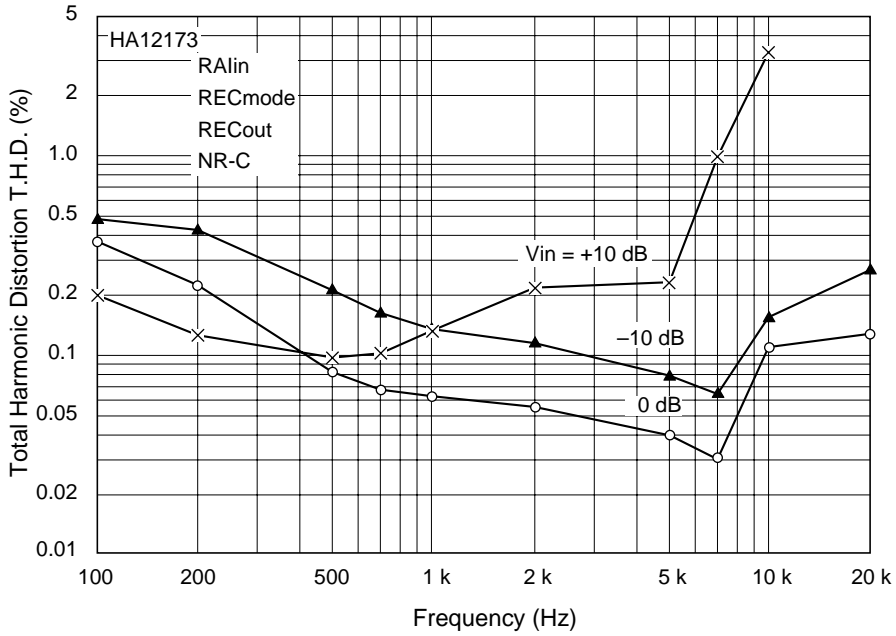

Crosstalk vs. Frequency (1)

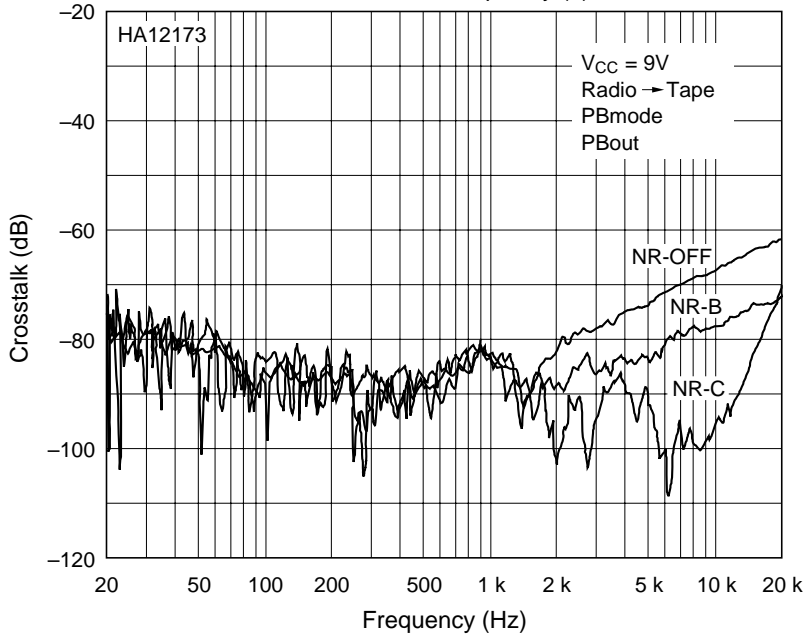

HA12173 Series

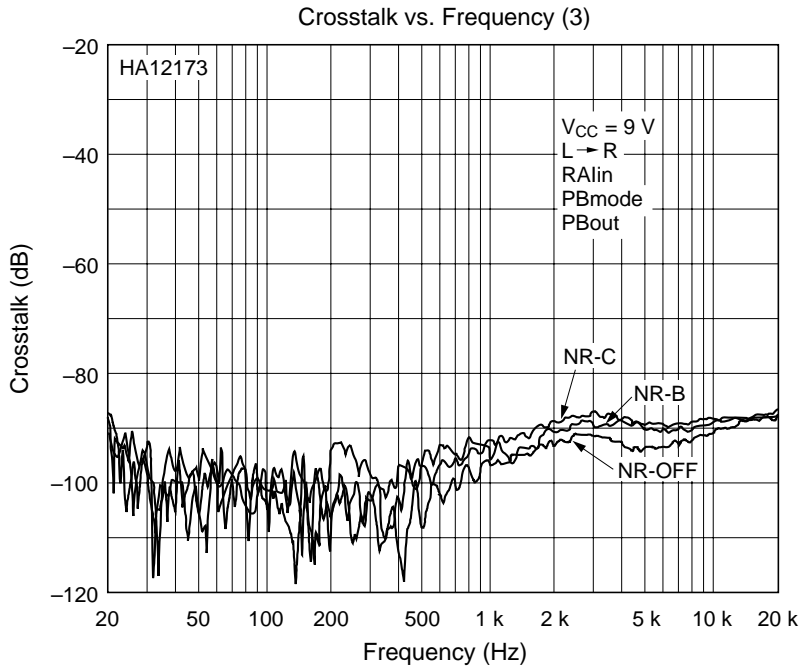
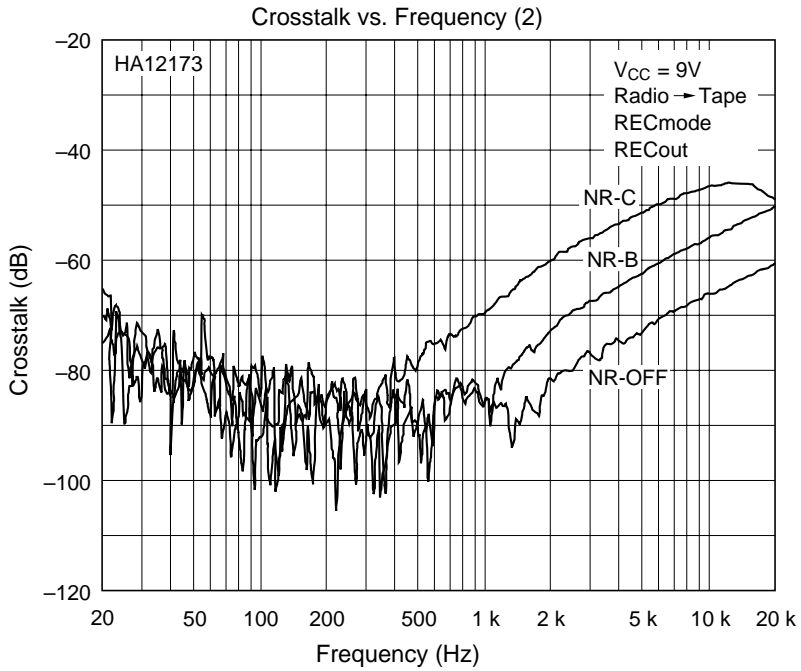

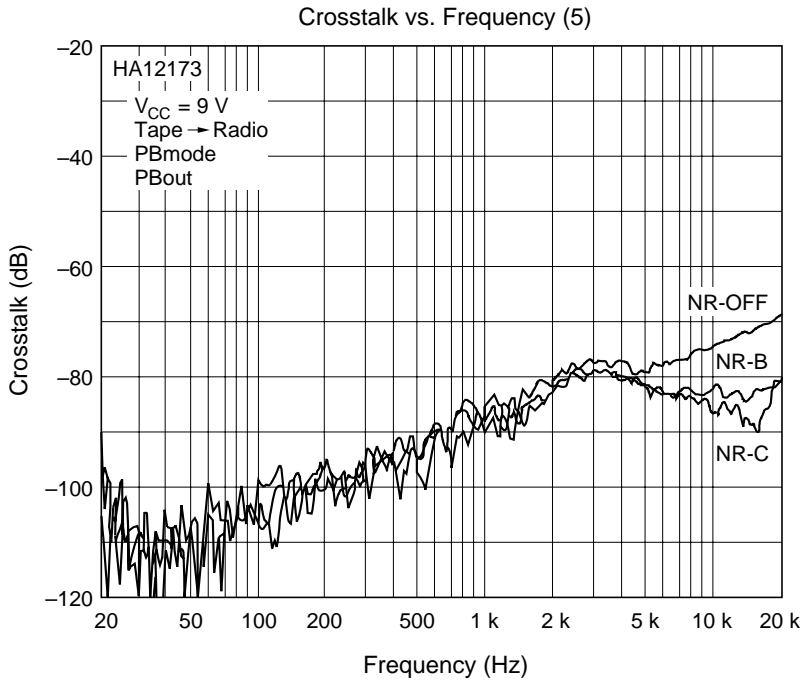
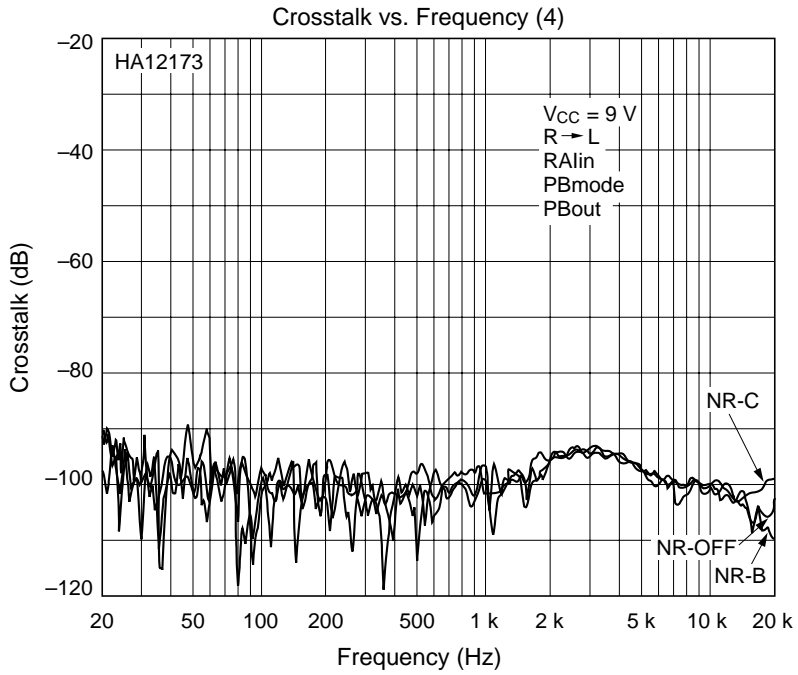

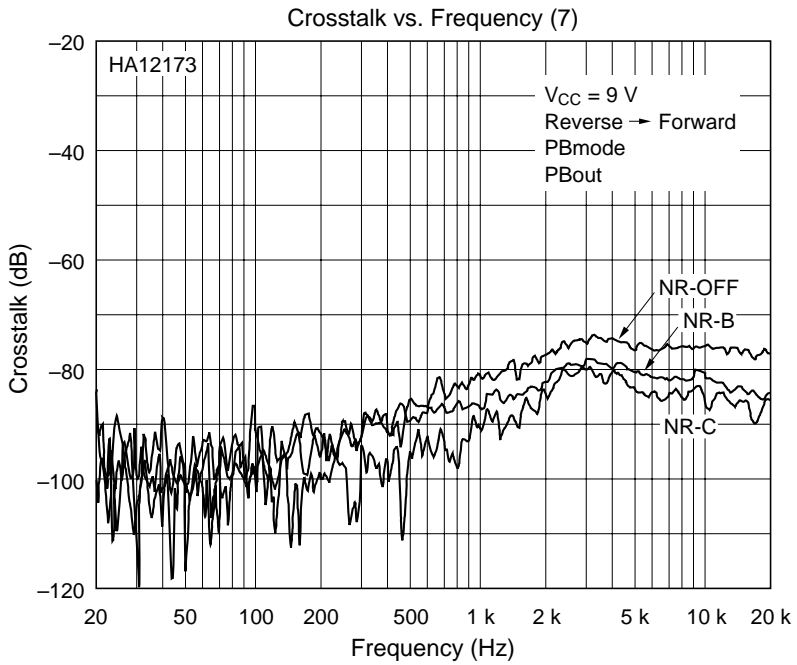
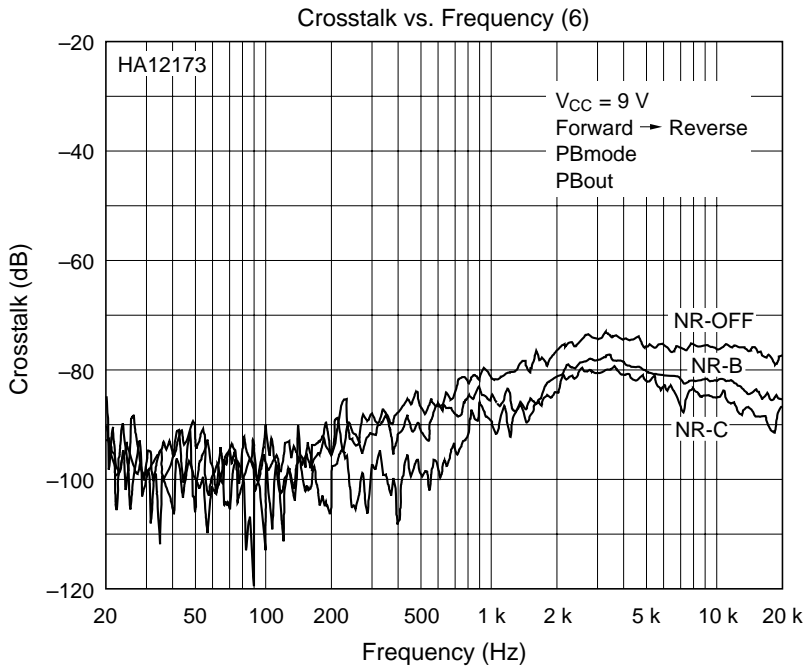

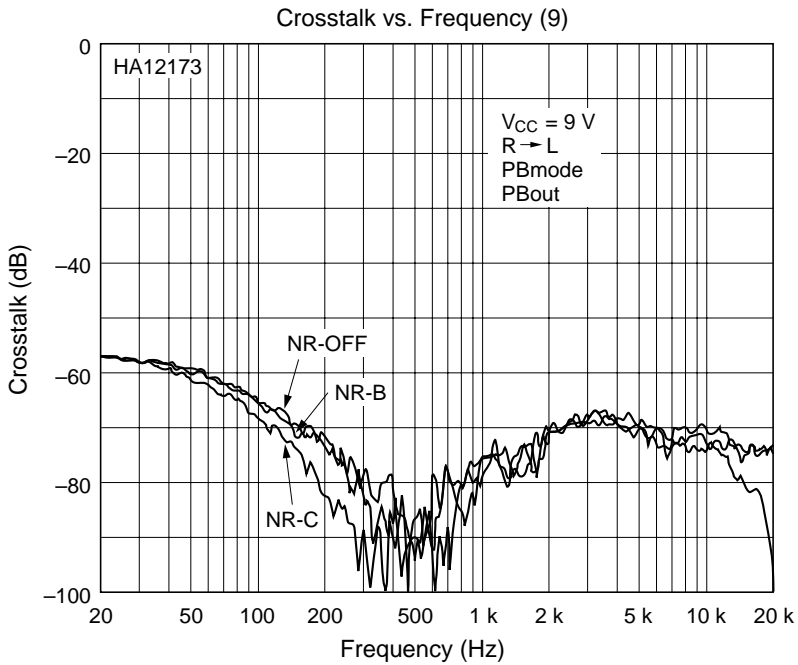
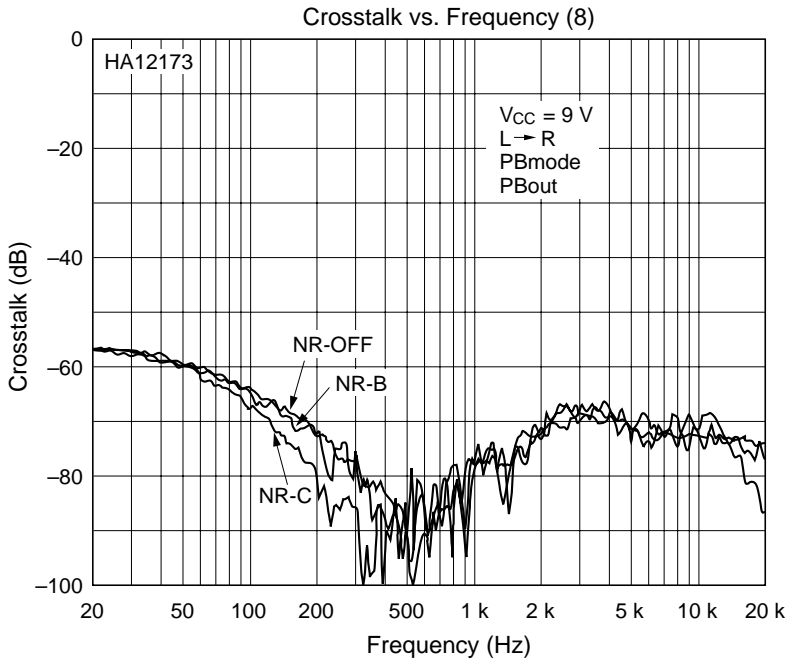

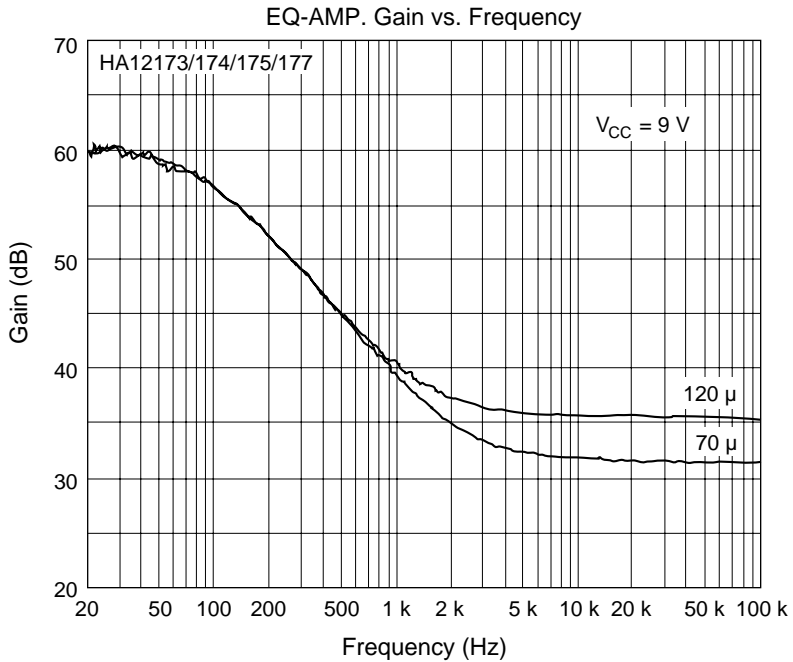
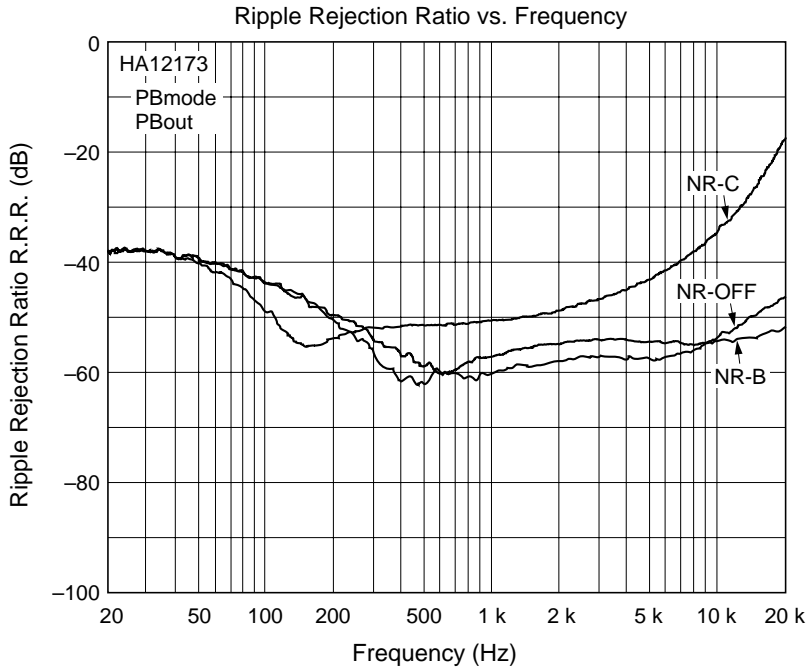

EQOUT Maximum Output Level vs. Supply Voltage

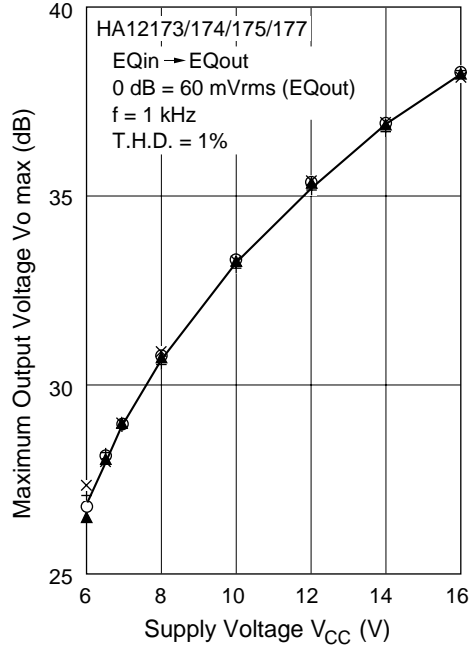

Signal to Noise Ratio vs. Supply Voltage

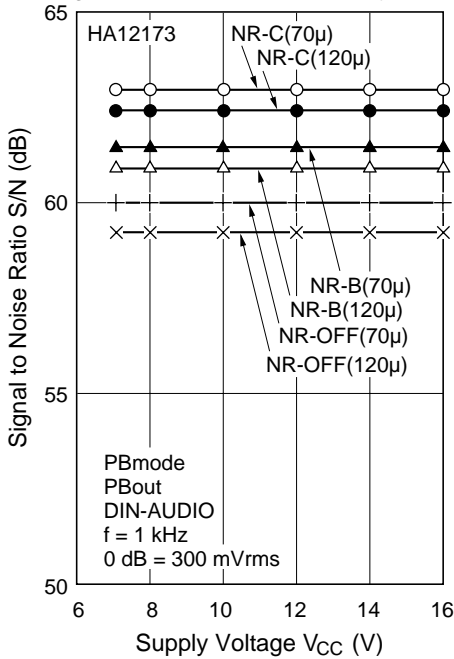

Total Harmonic Distortion vs. Supply Voltage

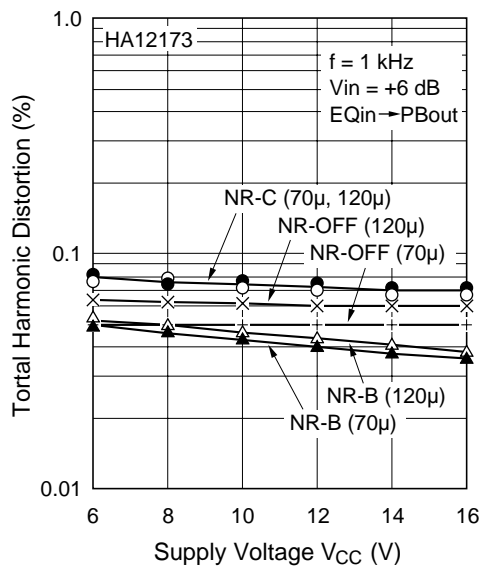

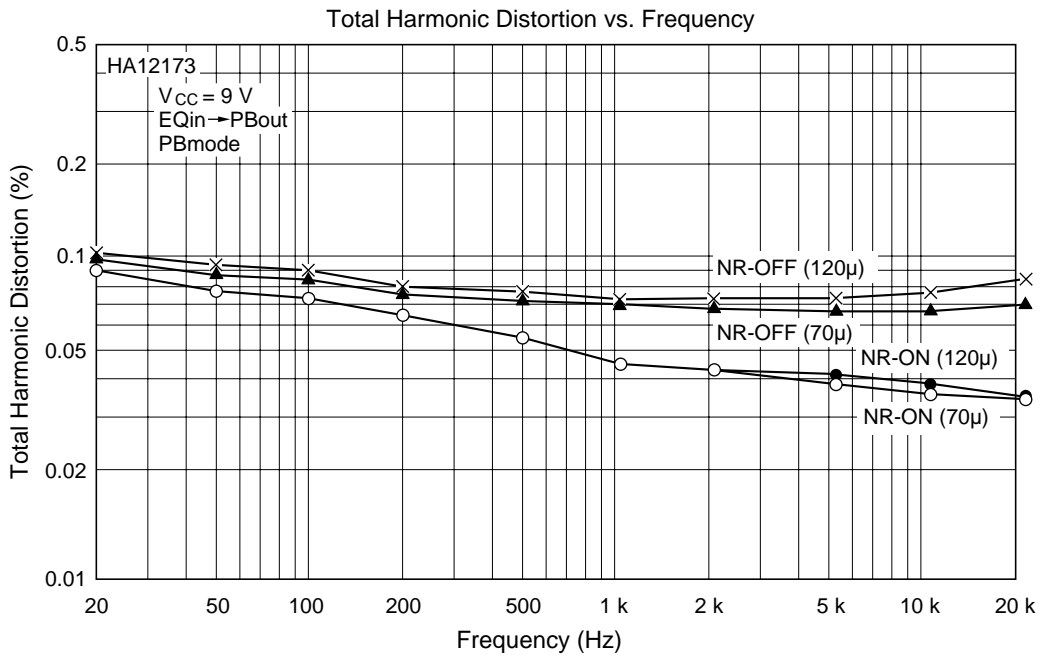
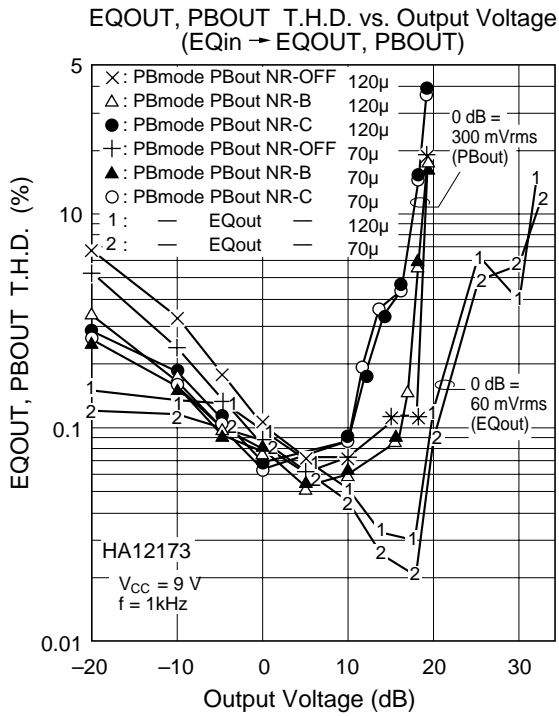

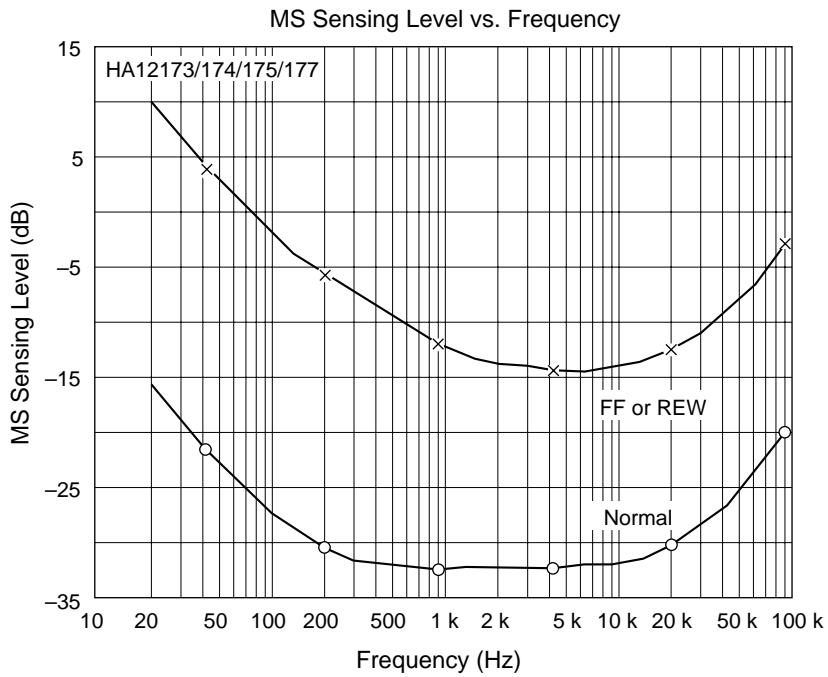
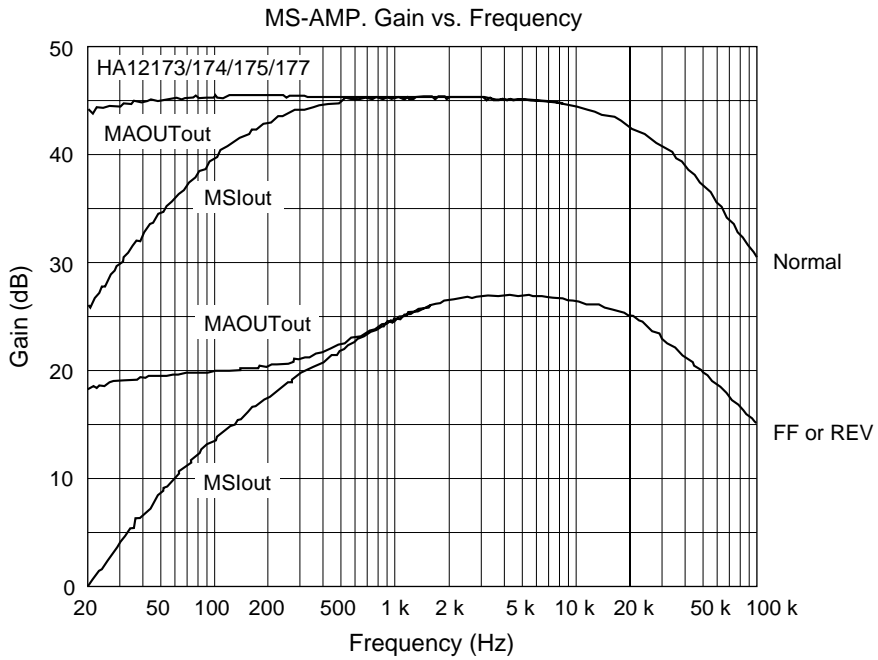

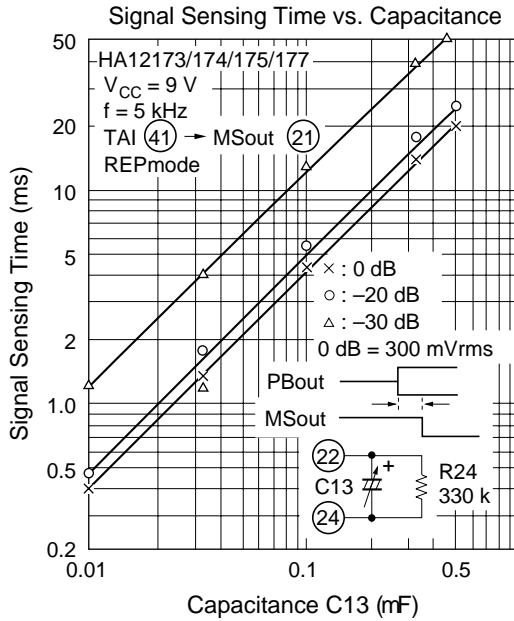
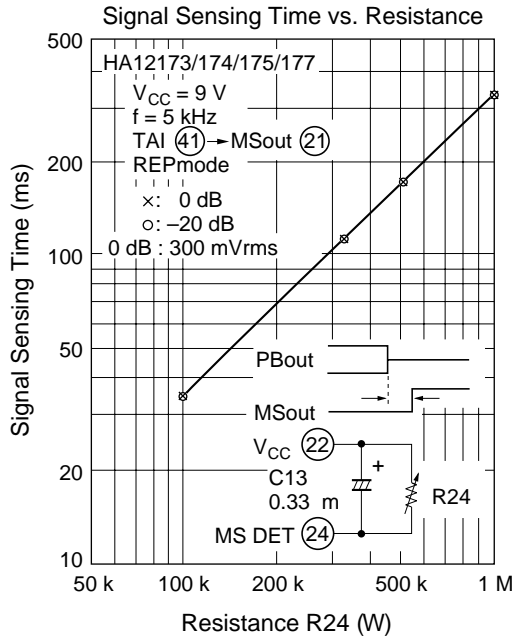

HA12174

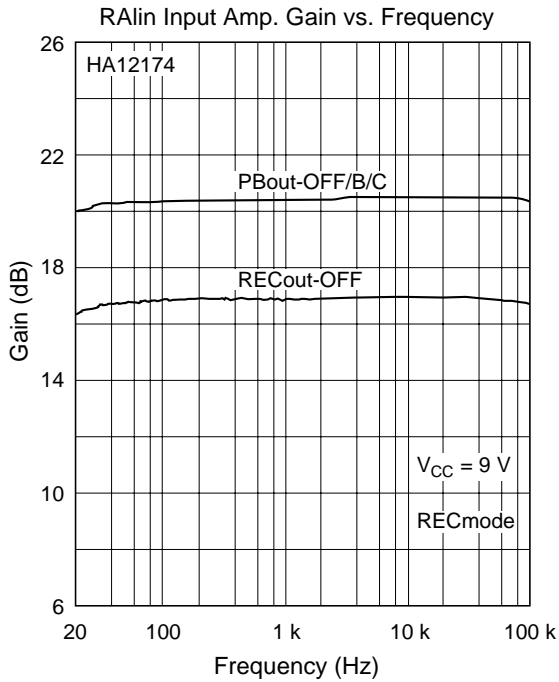
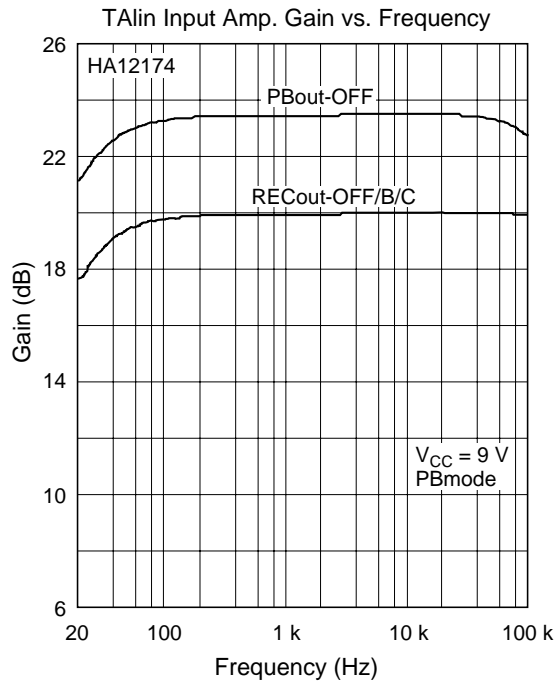

HA12173 Series

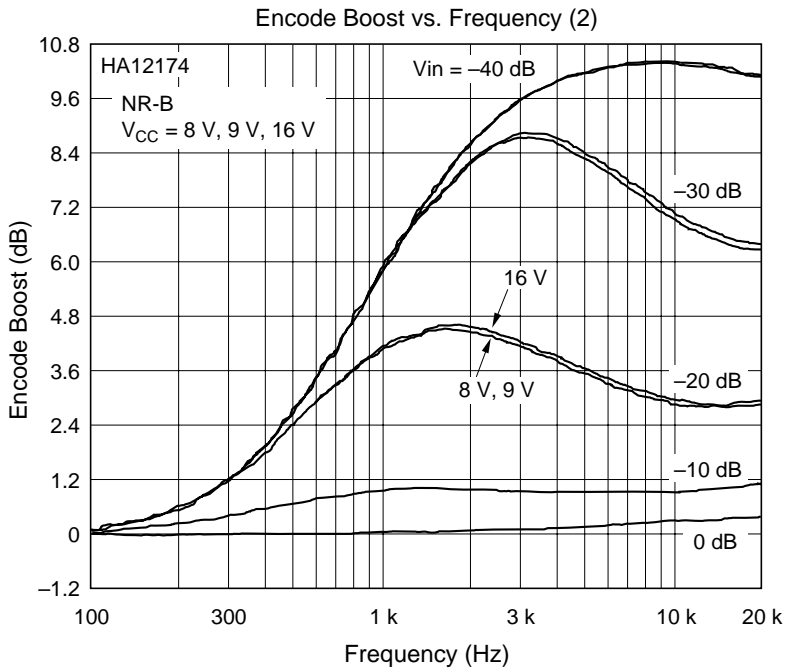
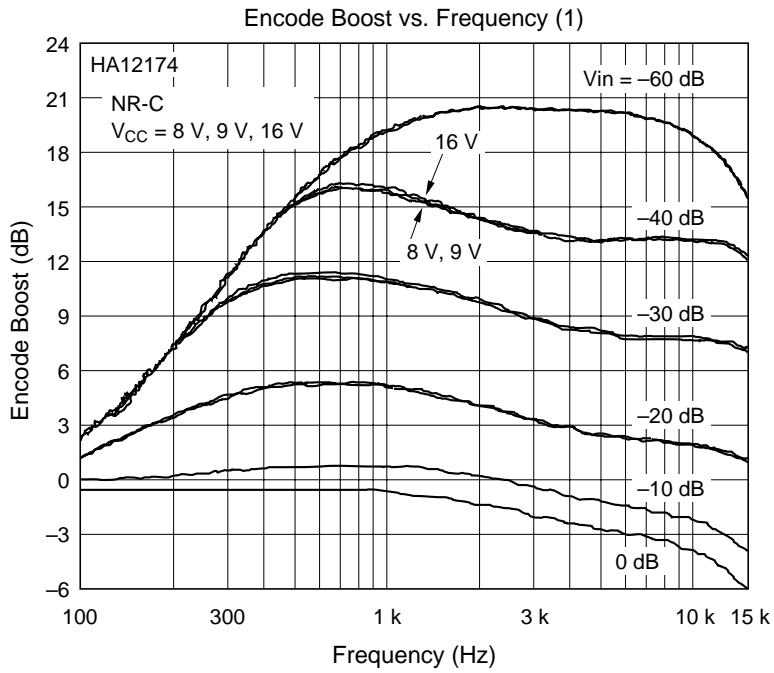

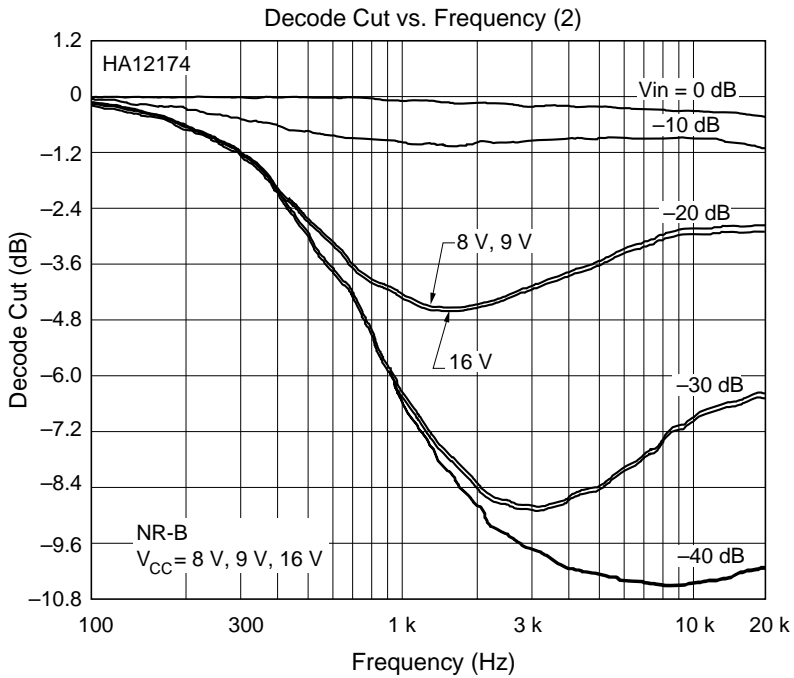
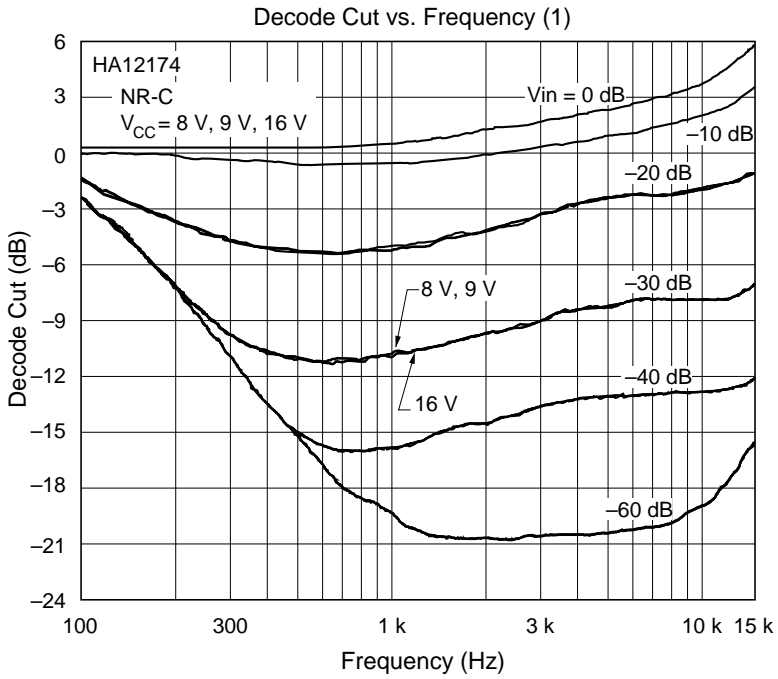

HA12173 Series

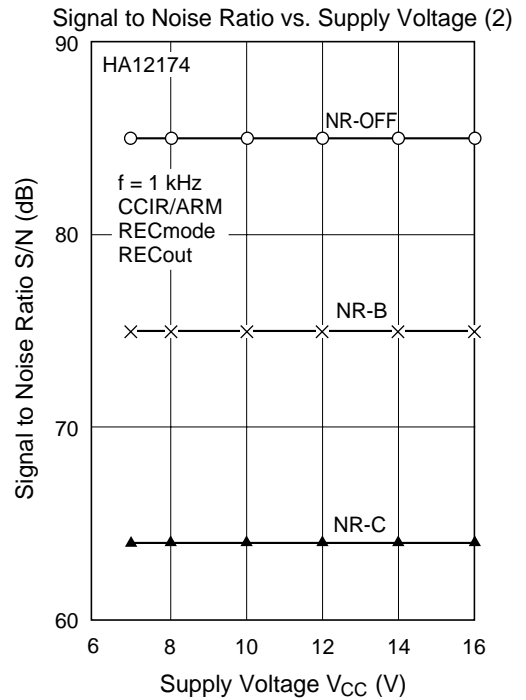
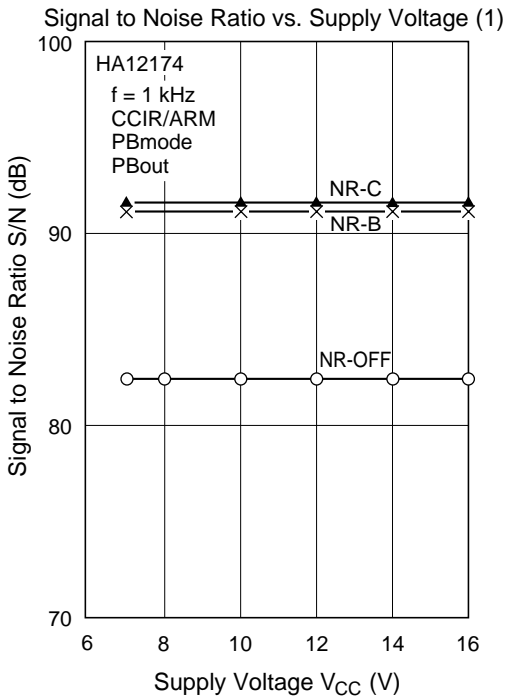
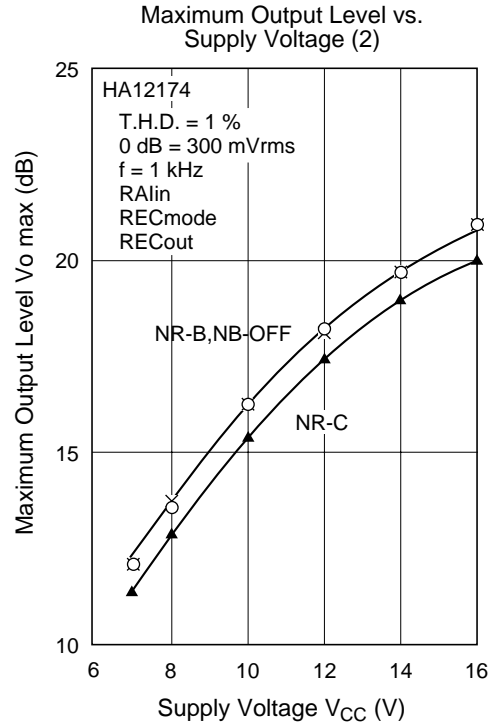
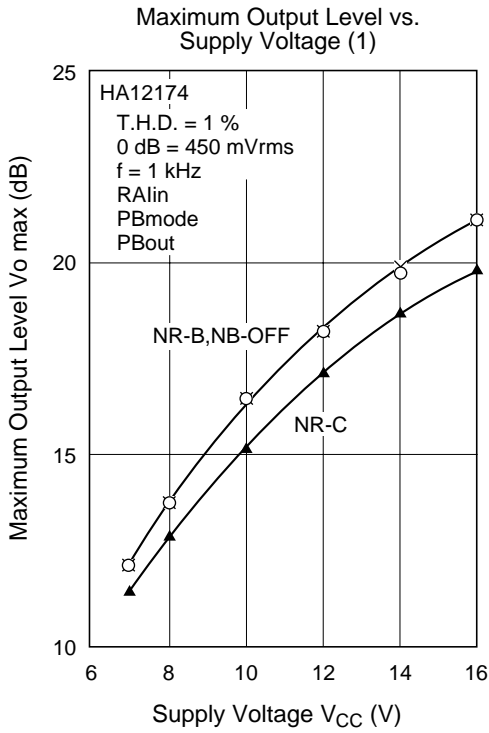

Total Harmonic Distortion vs. Output Level (1)

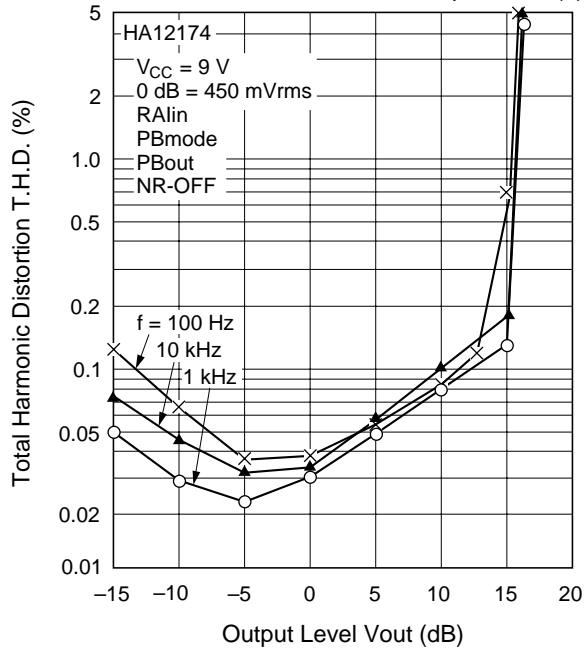

Total Harmonic Distortion vs. Output Level (2)

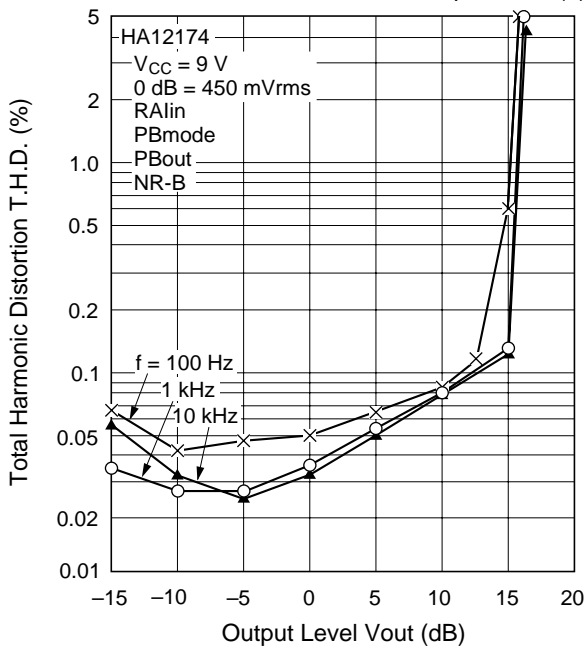

HA12173 Series

Total Harmonic Distortion vs. Output Level (3)

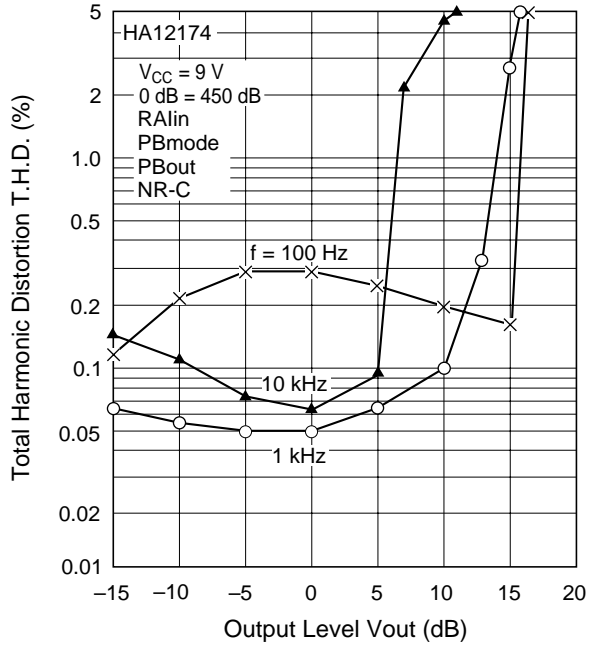

Total Harmonic Distortion vs. Output Level (4)

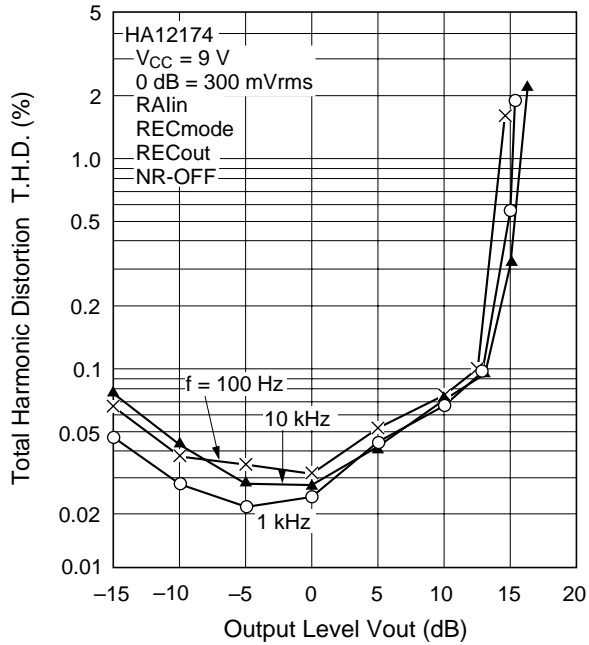

Total Harmonic Distortion vs. Output Level (5)

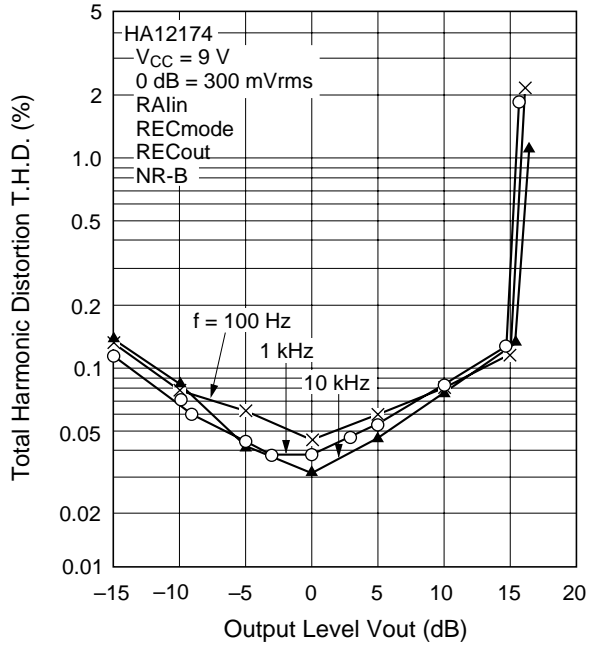

Total Harmonic Distortion vs. Output Level (6)

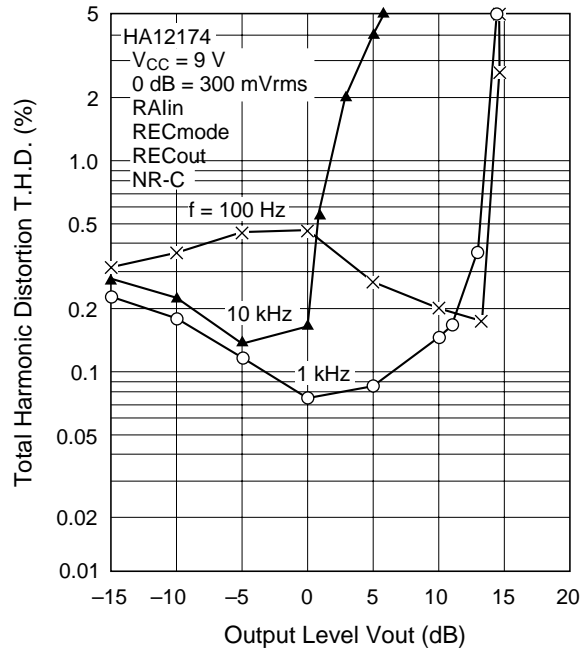

HA12173 Series

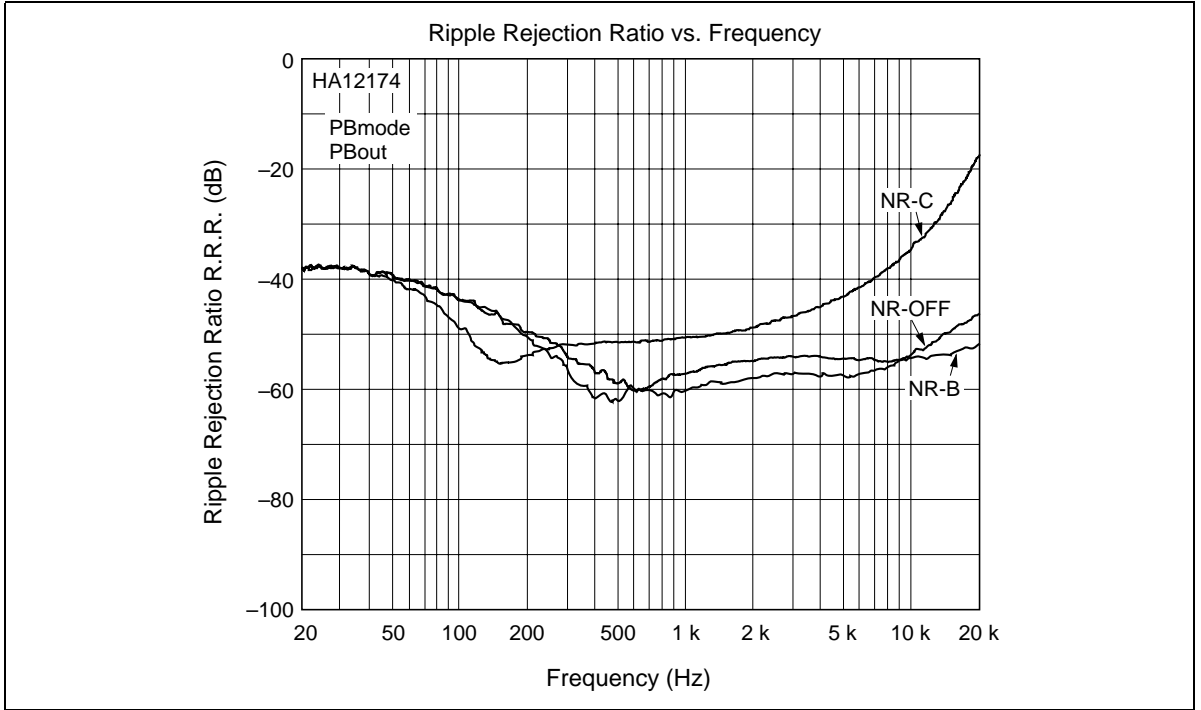

HA12175

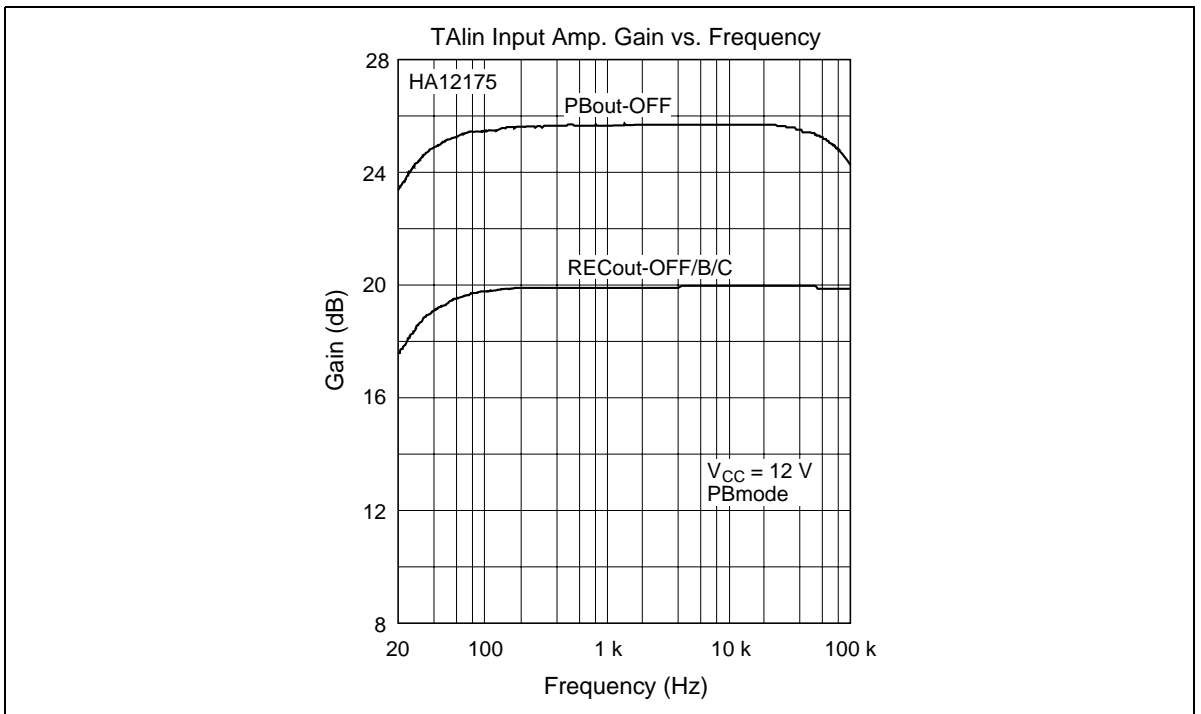

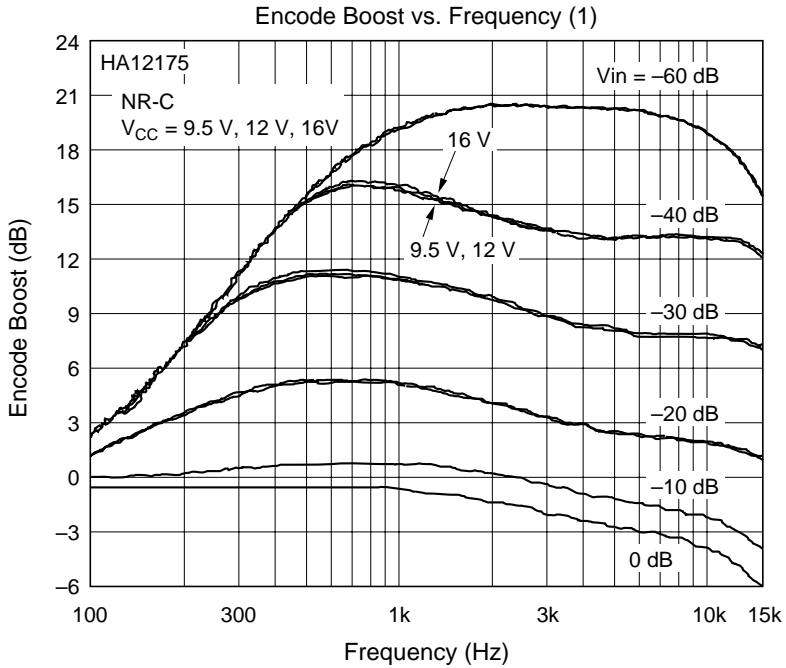
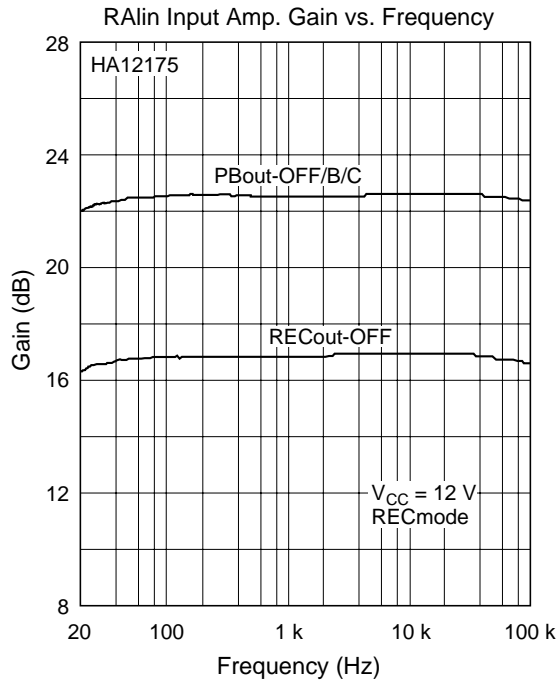

HA12173 Series

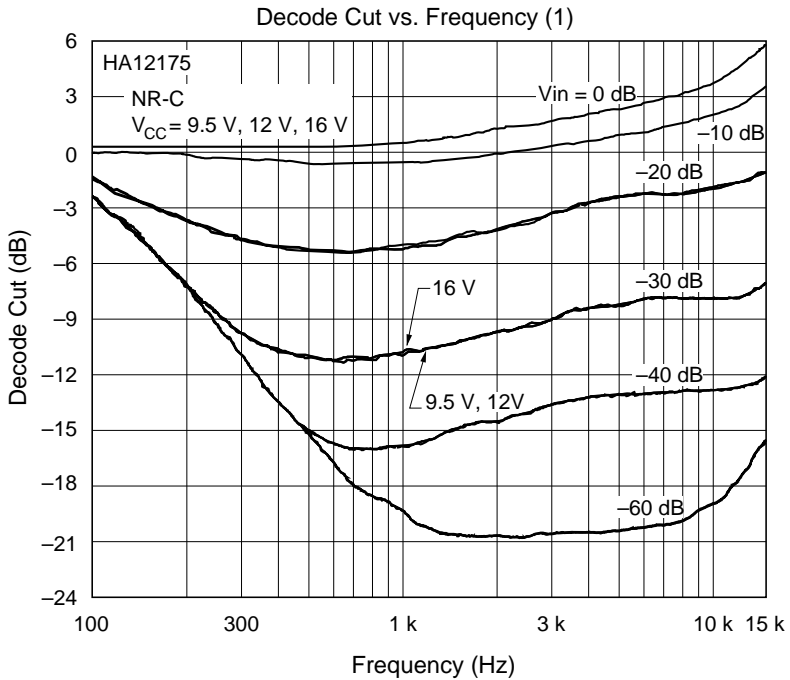
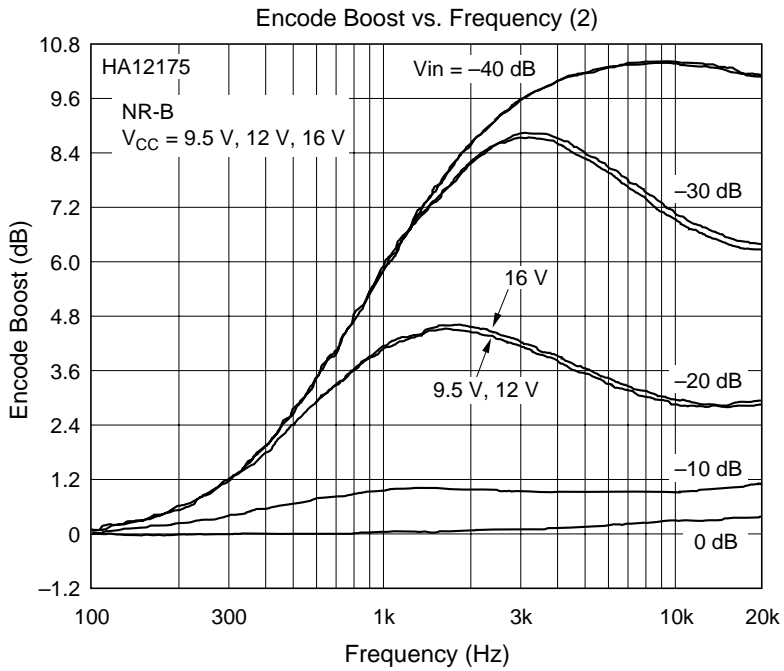

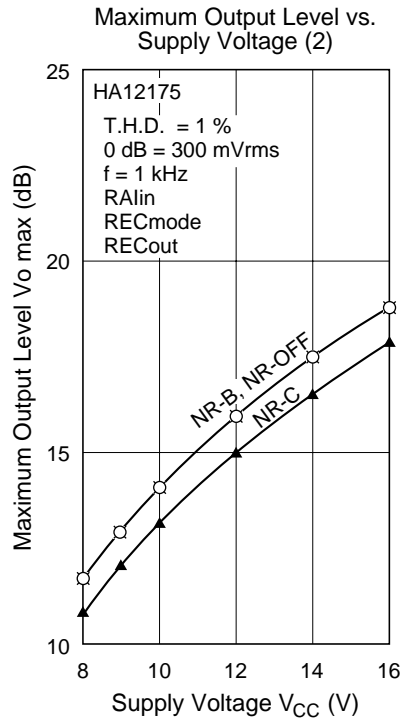
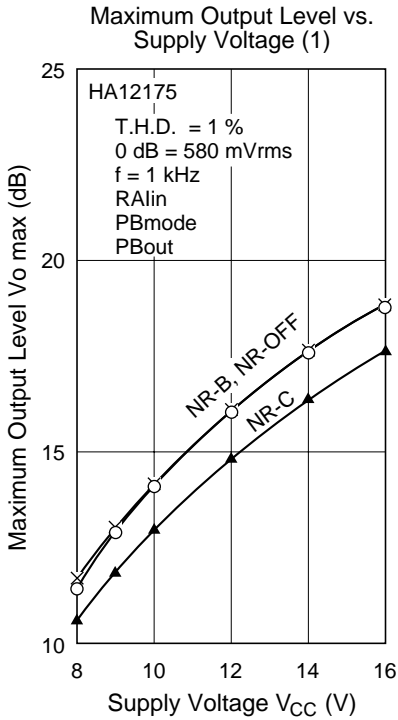
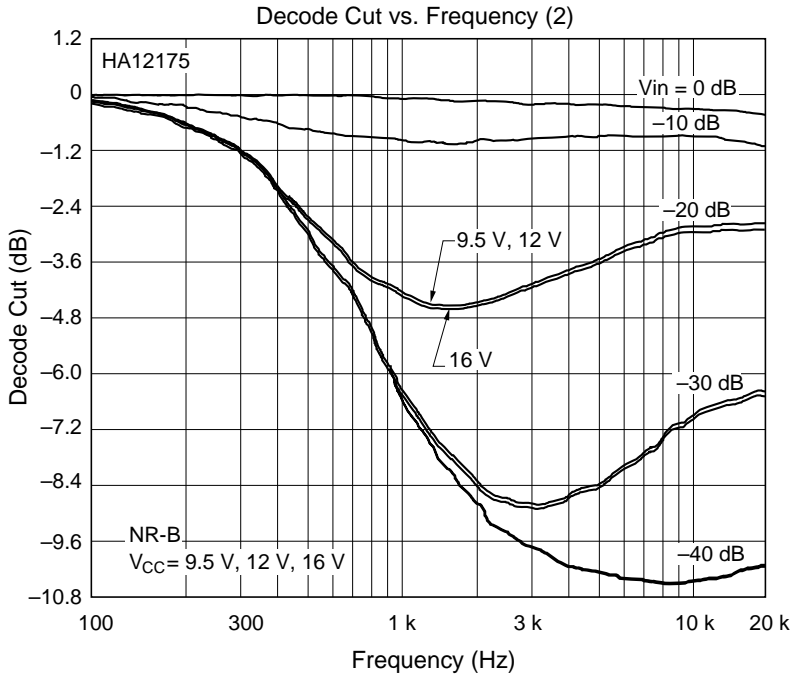

HA12173 Series

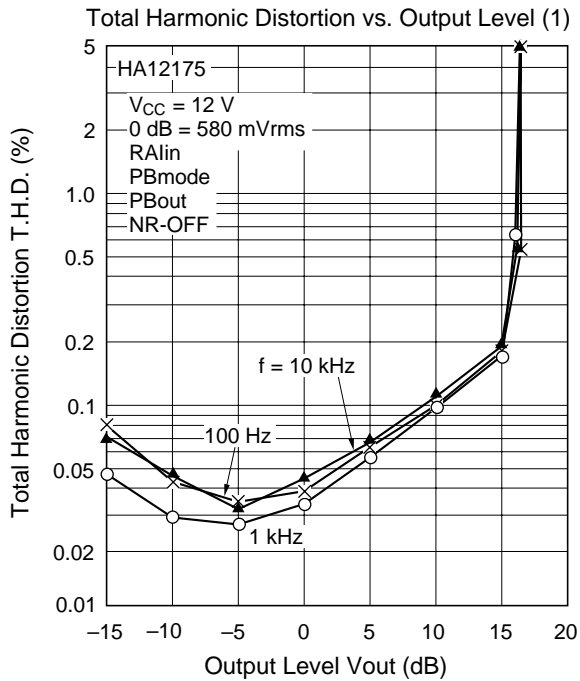
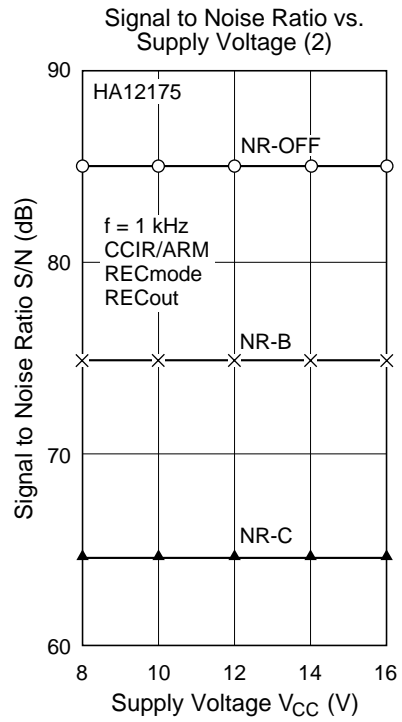
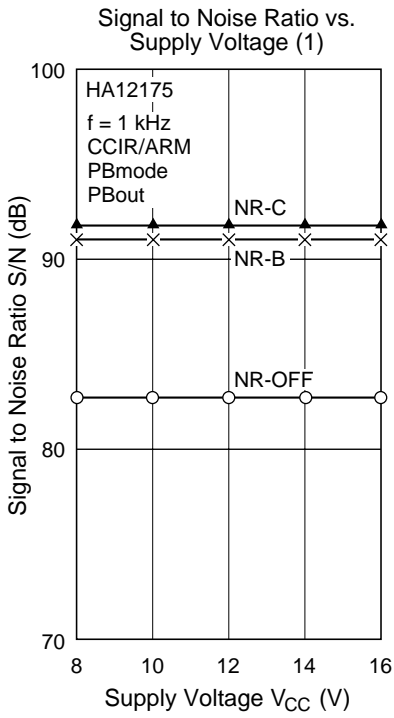

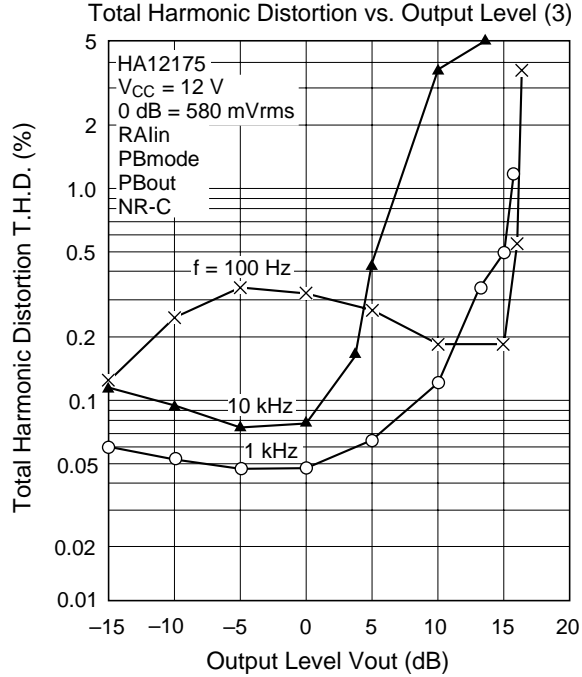
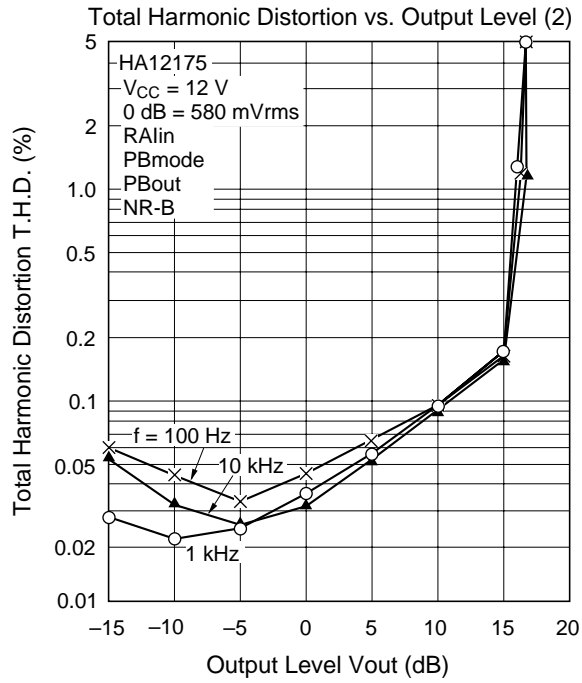

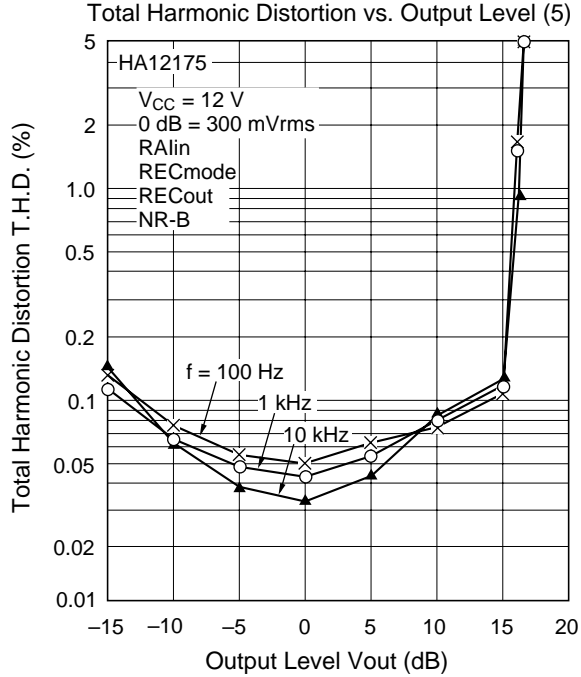
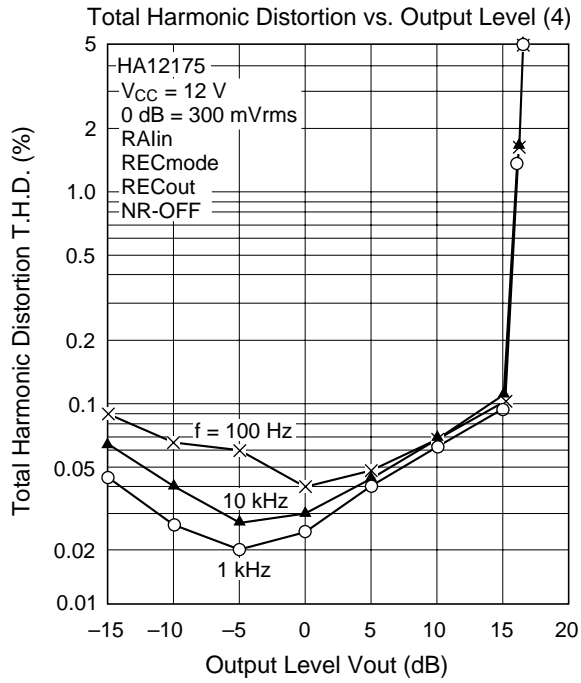

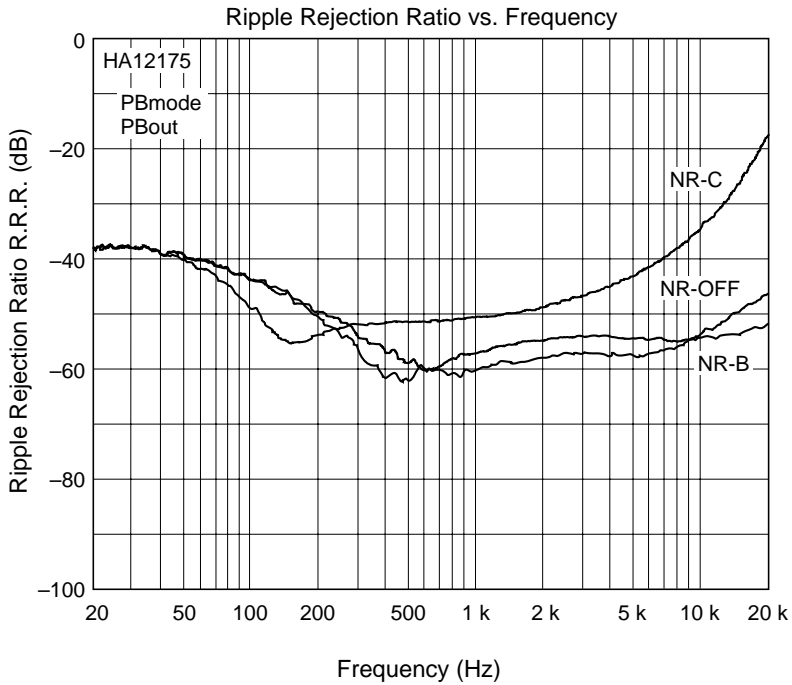
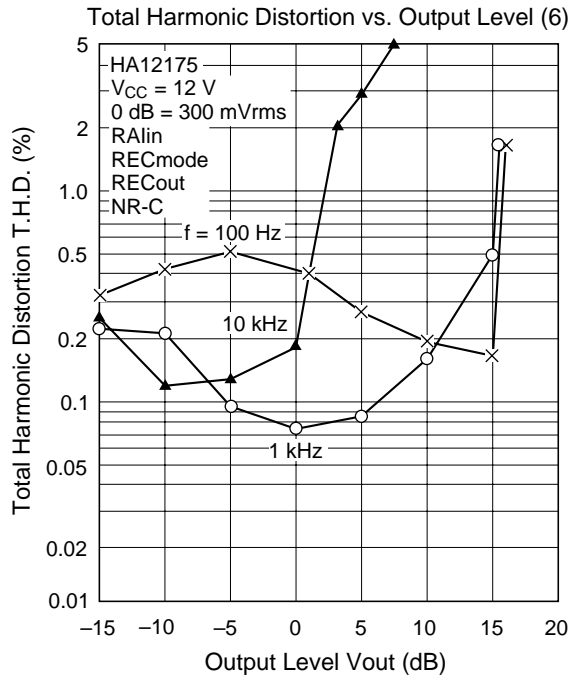

HA12173 Series

HA12177

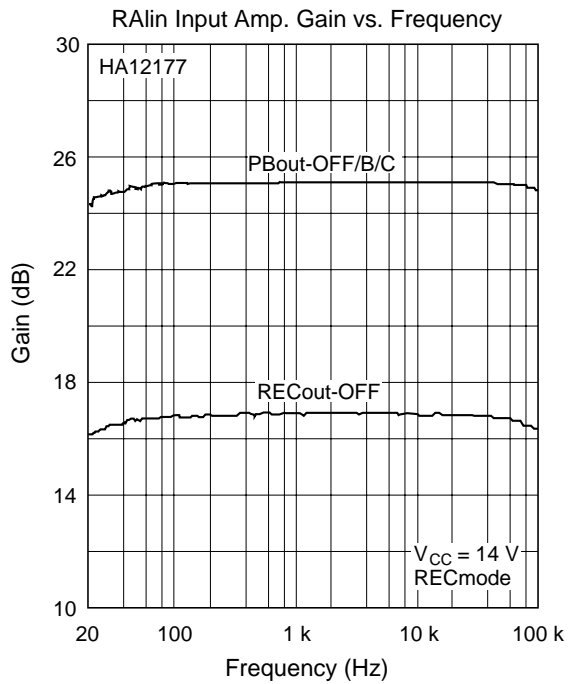
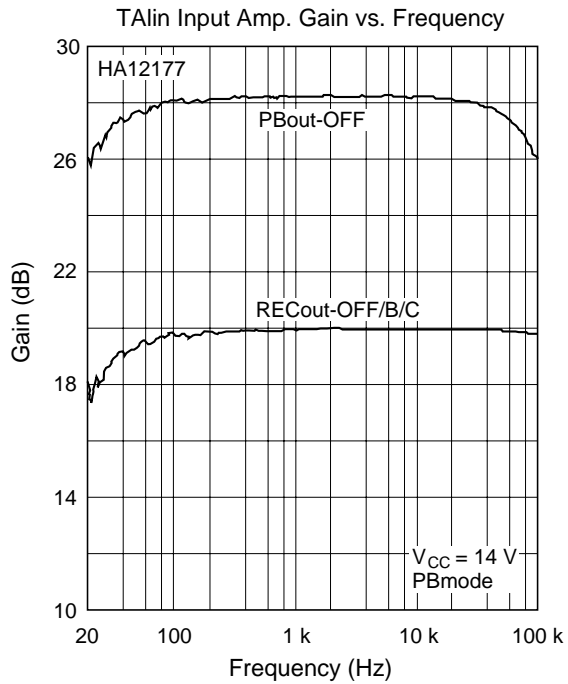

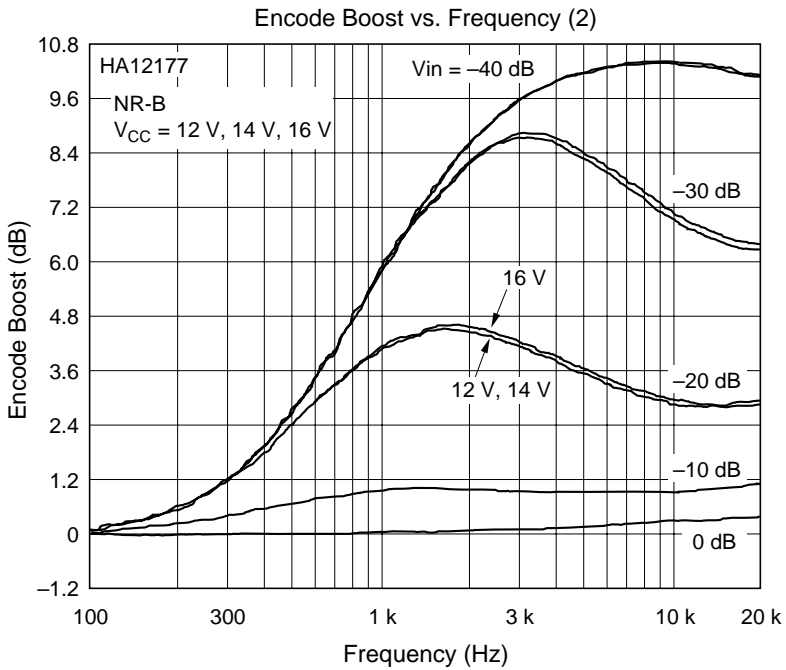
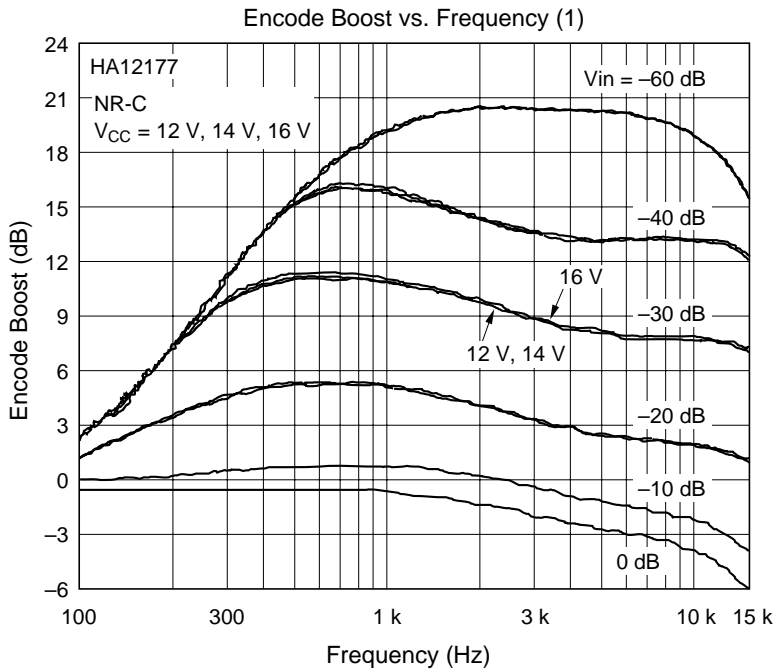

HA12173 Series

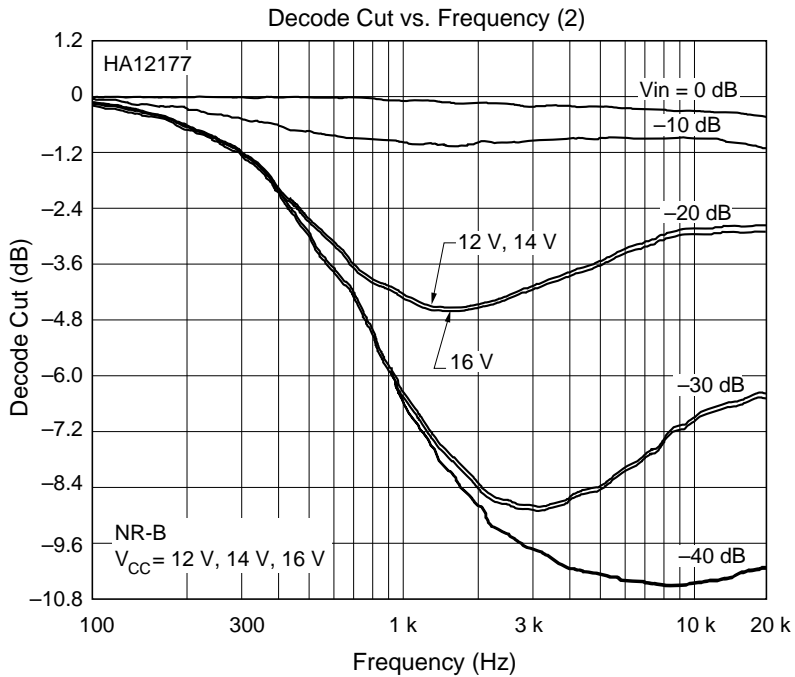
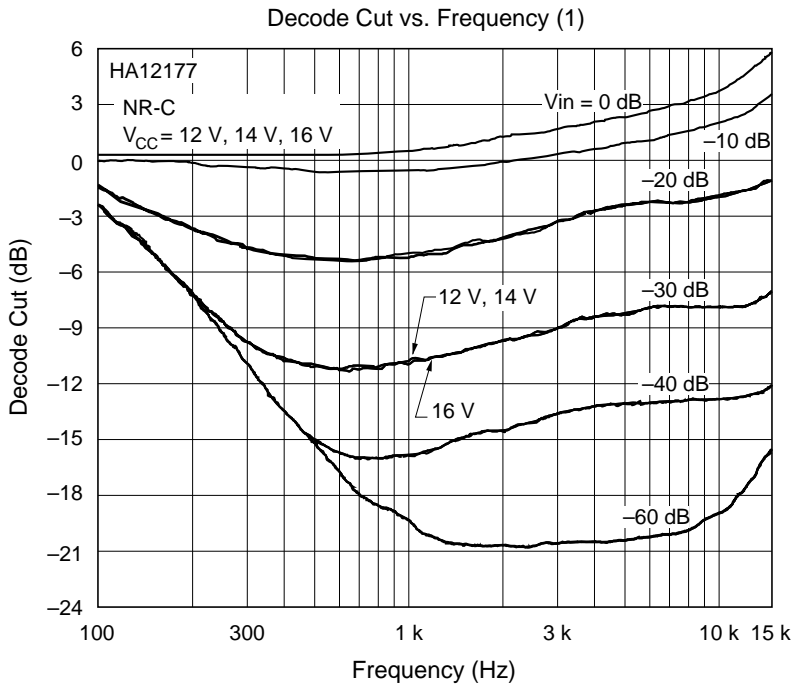

Maximum Output Level vs. Supply Voltage (1)

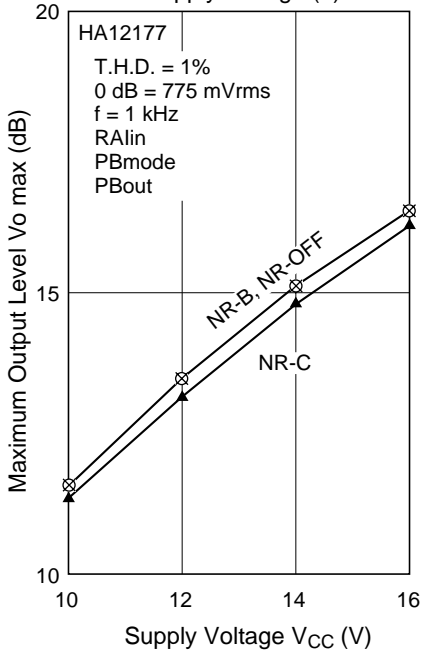

Maximum Output Level vs. Supply Voltage (2)

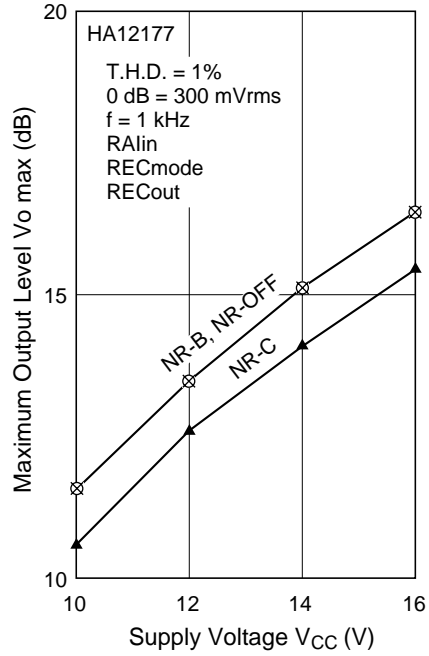

Signal to Noise Ratio vs. Supply Voltage (1)

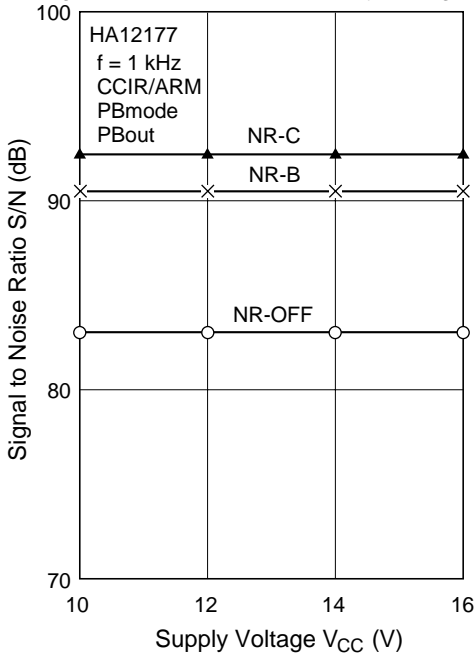

Signal to Noise Ratio vs. Supply Voltage (2)

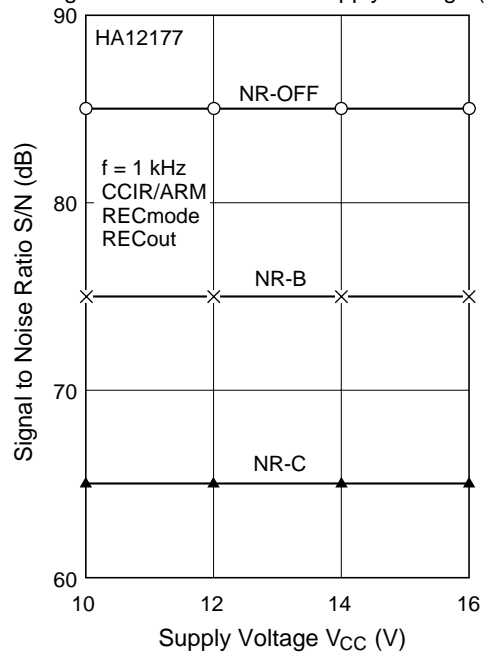

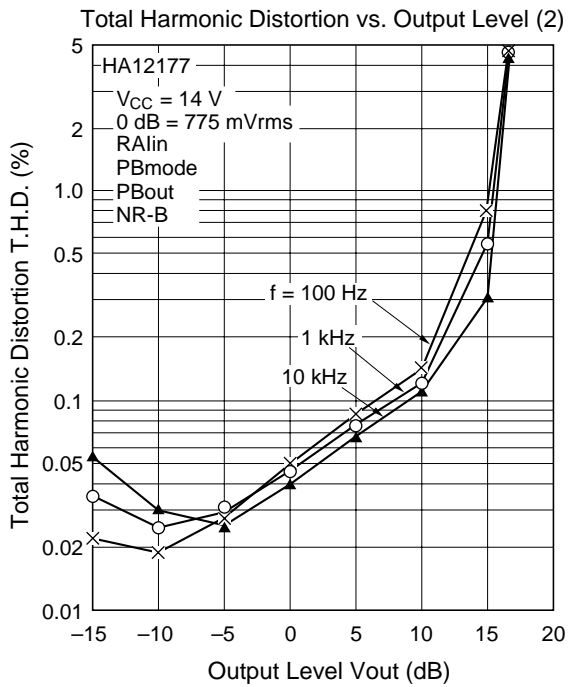
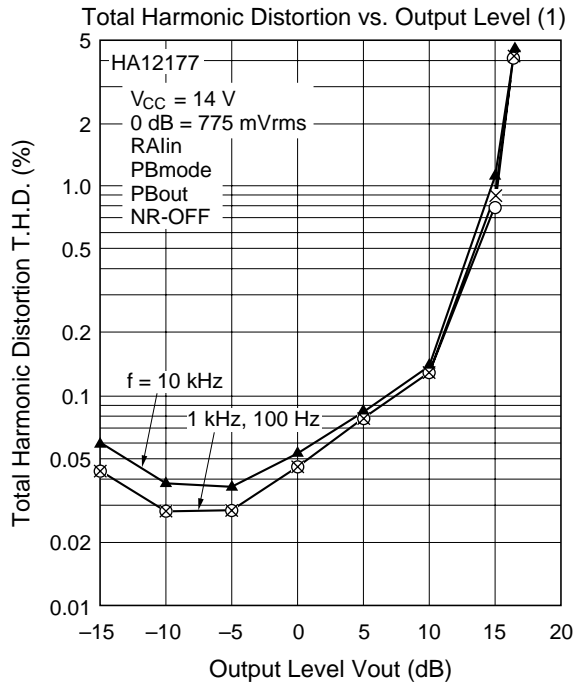

Total Harmonic Distortion vs. Output Level (3)

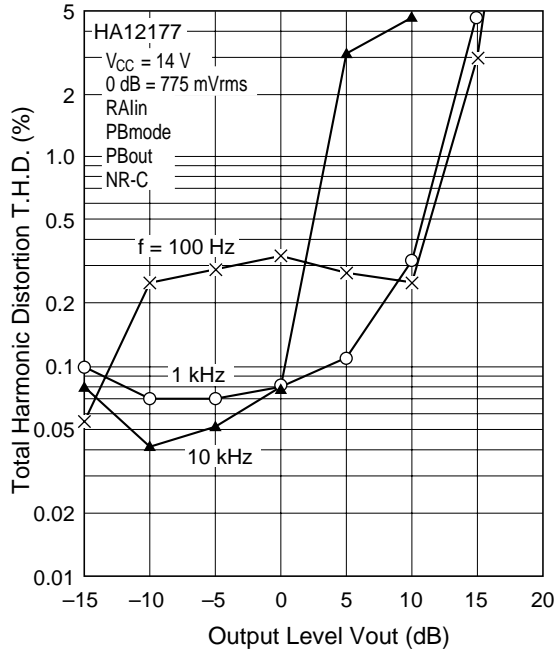

Total Harmonic Distortion vs. Output Level (4)

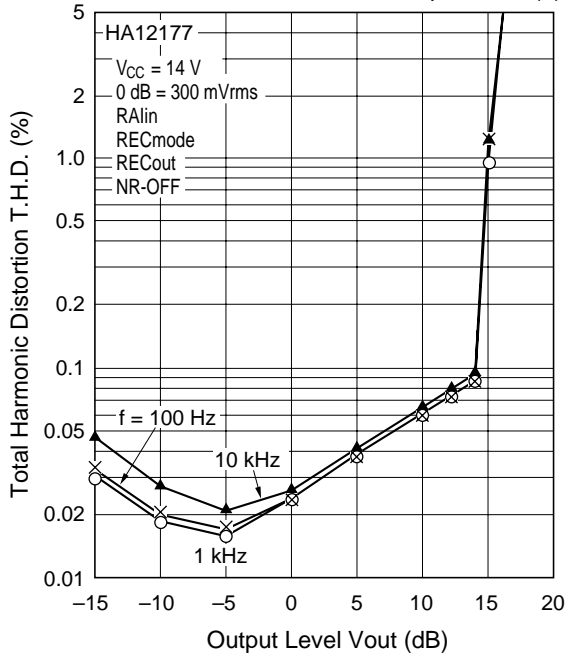

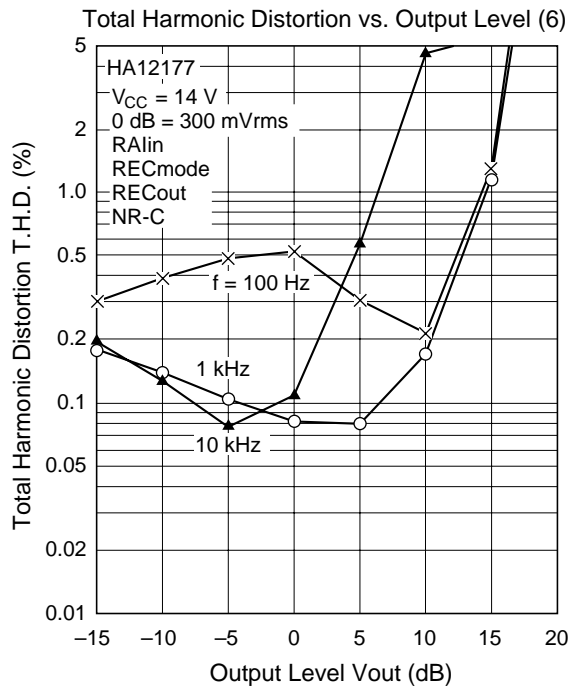
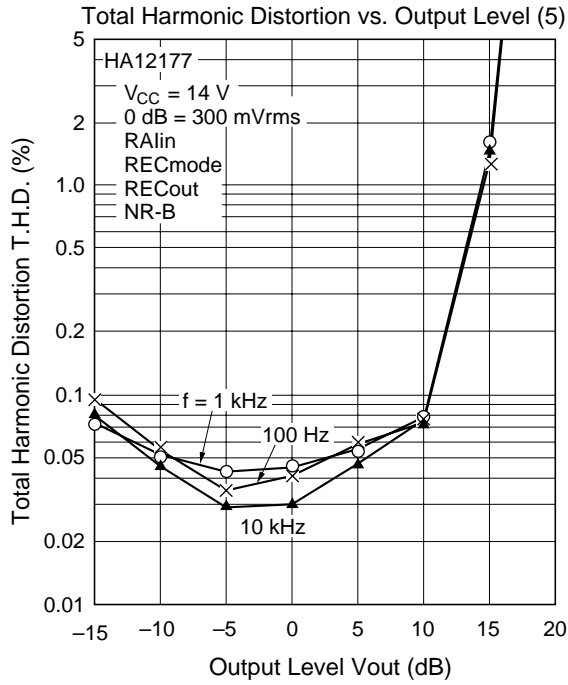

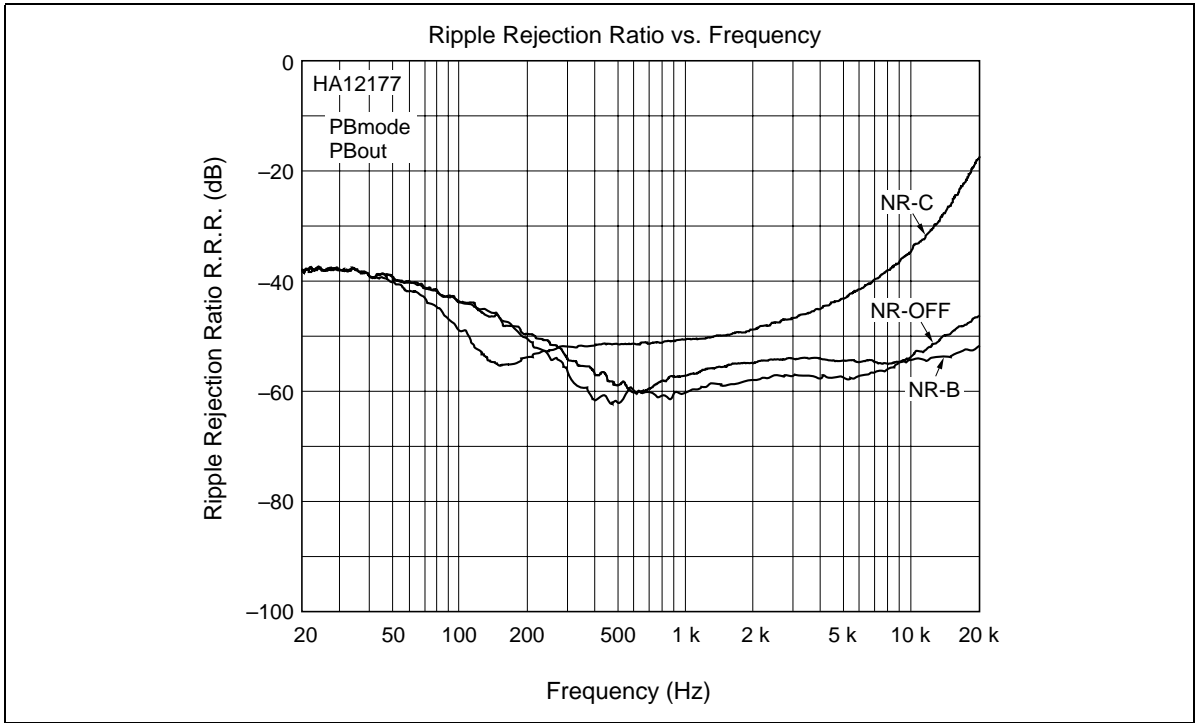

HA12173 Series

Disclaimer

1. Hitachi neither warrants nor grants licenses of any rights of Hitachi's or any third party's patent, copyright, trademark, or other intellectual property rights for information contained in this document. Hitachi bears no responsibility for problems that may arise with third party's rights, including intellectual property rights, in connection with use of the information contained in this document.
2. Products and product specifications may be subject to change without notice. Confirm that you have received the latest product standards or specifications before final design, purchase or use.
3. Hitachi makes every attempt to ensure that its products are of high quality and reliability. However, contact Hitachi's sales office before using the product in an application that demands especially high quality and reliability or where its failure or malfunction may directly threaten human life or cause risk of bodily injury, such as aerospace, aeronautics, nuclear power, combustion control, transportation, traffic, safety equipment or medical equipment for life support.
4. Design your application so that the product is used within the ranges guaranteed by Hitachi particularly for maximum rating, operating supply voltage range, heat radiation characteristics, installation conditions and other characteristics. Hitachi bears no responsibility for failure or damage when used beyond the guaranteed ranges. Even within the guaranteed ranges, consider normally foreseeable failure rates or failure modes in semiconductor devices and employ systemic measures such as fail-safes, so that the equipment incorporating Hitachi product does not cause bodily injury, fire or other consequential damage due to operation of the Hitachi product.
5. This product is not designed to be radiation resistant.
6. No one is permitted to reproduce or duplicate, in any form, the whole or part of this document without written approval from Hitachi.
7. Contact Hitachi's sales office for any questions regarding this document or Hitachi semiconductor products.

Sales Offices

HITACHI

Hitachi, Ltd.

Semiconductor & Integrated Circuits.
Nippon Bldg., 2-6-2, Ohte-machi, Chiyoda-ku, Tokyo 100-0004, Japan
Tel: Tokyo (03) 3270-2111 Fax: (03) 3270-5109

URL NorthAmerica : <http://semiconductor.hitachi.com/>
 Europe : <http://www.hitachi-eu.com/hel/ecg>
 Asia : <http://sicapac.hitachi-asia.com>
 Japan : <http://www.hitachi.co.jp/Sicd/indx.htm>

For further information write to:

Hitachi Semiconductor
(America) Inc.
179 East Tasman Drive,
San Jose, CA 95134
Tel: <1>(408) 433-1990
Fax: <1>(408) 433-0223

Hitachi Europe GmbH
Electronic Components Group
Dornacher Straße 3
D-85622 Feldkirchen, Munich
Germany
Tel: <49> (89) 9 9180-0
Fax: <49> (89) 9 29 30 00

Hitachi Europe Ltd.
Electronic Components Group.
Whitebrook Park
Lower Cookham Road
Maidenhead
Berkshire SL6 8YA, United Kingdom
Tel: <44> (1628) 585000
Fax: <44> (1628) 585160

Hitachi Asia Ltd.
Hitachi Tower
16 Collyer Quay #20-00,
Singapore 049318
Tel : <65>-538-6533/538-8577
Fax : <65>-538-6933/538-3877
URL : <http://www.hitachi.com.sg>

Hitachi Asia Ltd.
(Taipei Branch Office)
4/F, No. 167, Tun Hwa North Road,
Hung-Kuo Building,
Taipei (105), Taiwan
Tel : <886>-(2)-2718-3666
Fax : <886>-(2)-2718-8180
Telex : 23222 HAS-TP
URL : <http://www.hitachi.com.tw>

Hitachi Asia (Hong Kong) Ltd.
Group III (Electronic Components)
7/F., North Tower,
World Finance Centre,
Harbour City, Canton Road
Tsim Sha Tsui, Kowloon,
Hong Kong
Tel : <852>-(2)-735-9218
Fax : <852>-(2)-730-0281
URL : <http://www.hitachi.com.hk>

Copyright © Hitachi, Ltd., 2000. All rights reserved. Printed in Japan.
Colophon 2.0