

# HA12412

## FM IF SYSTEM

The Hitachi HA12412 is specifically designed for FM IF system. Many functions are included, saving labour and miniaturizing sets.

### FUNCTIONS

- FM IF Amplifier
- Quadrature Detector
- Audio Amplifier
- Muting Circuit
- Signal-Meter Driver
- AFC
- Center-Meter Driver
- Muting Controller (Bandwidth Muting & Level Muting)
- Center-Meter Short Circuit for AM-band (Pin-15)
- IF Amp Killer for AM-band (Pin-15)

### FEATURES

- Low THD ... 0.01% typ
- High Signal-to-Noise Ratio ... 88 dB typ
- High Sensitivity ...  $V_{in(lim)} = 31\text{dB}\mu$  typ
- Large Muting-Attenuation ... 100dB typ
- Stable Operation by using Full-Balanced Differential

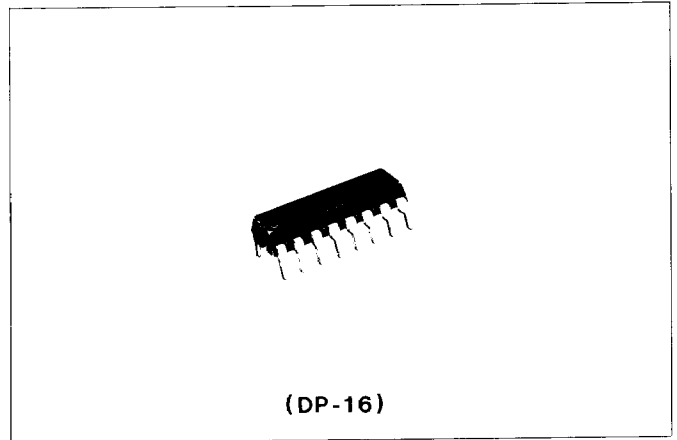

- Triplex Amplifier
- High Linearity of Signal Meter ...  $V_{in} = 42 \sim 105\text{dB}\mu$
- Operational Input Level of Muting is adjustable by controlling External Resistance.

Note) HA12412 is pin-compatible with HA11225, except pin-15.  
 Test Conditions:  $V_{in} = 100\text{dB}\mu$ ,  $f_m = 400\text{Hz}$ ,  $\Delta f = 75\text{kHz dev.}$   
 $f_c = 10.7\text{MHz}$

### BLOCK DIAGRAM

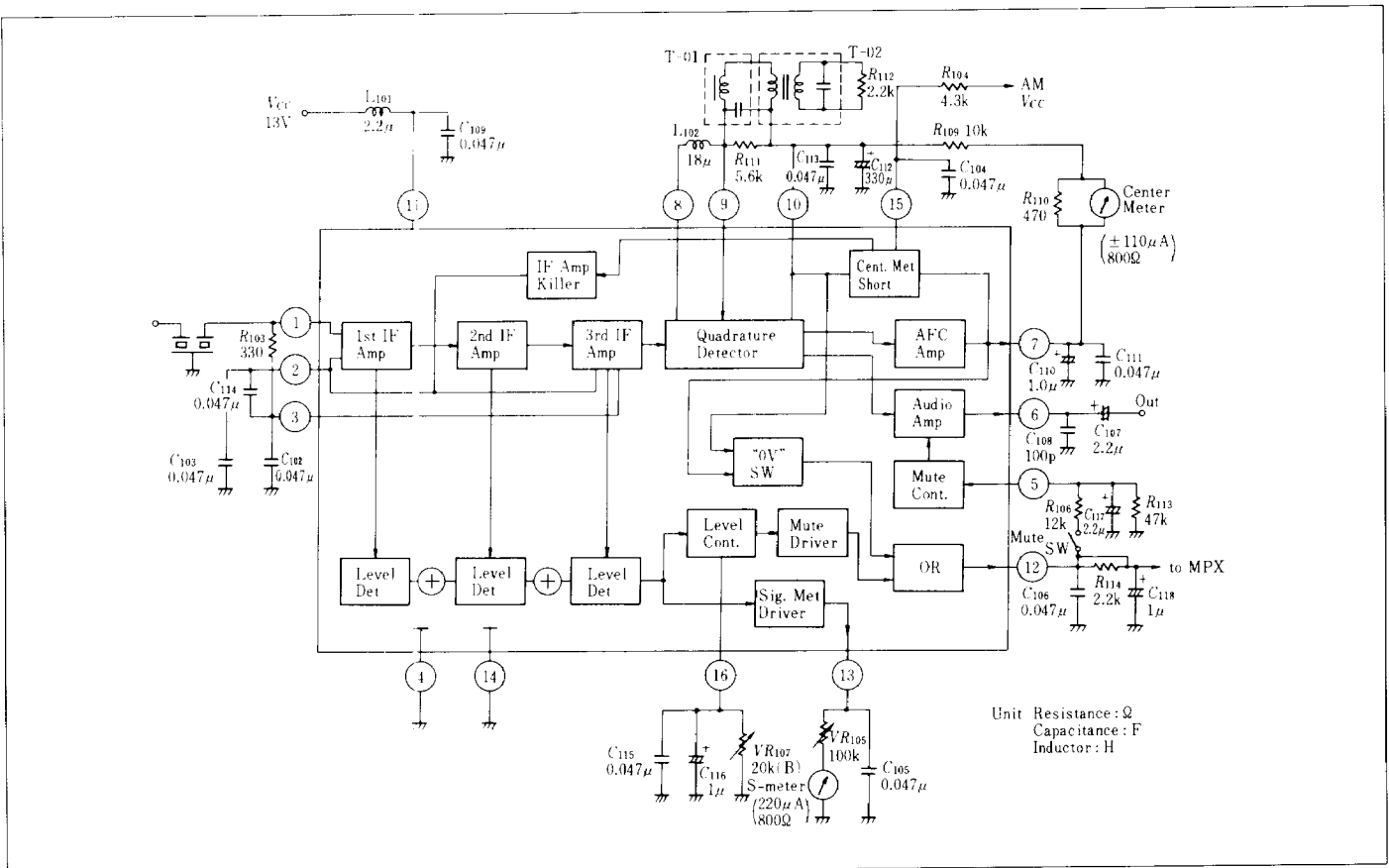

● ABSOLUTE MAXIMUM RATINGS

Item	Symbol	Rating	Unit
Supply Voltage	$V_{CC}$	15	V
Power Dissipation (Note)	$P_T$	590	mW
Operating Temperature Range	$T_{opr}$	-20 to +70	°C
Storage Temperature Range	$T_{stg}$	-55 to +125	°C

Note) Please refer to the following derating curve for  $T_a=60^\circ\text{C}$ .

● DERATING CURVE

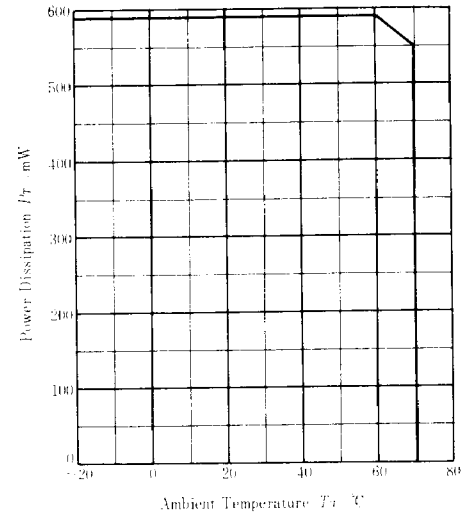

■ ELECTRICAL CHARACTERISTICS

(Unless otherwise specified,  $T_a=25^\circ\text{C}$ ,  $V_{CC}=13.0\text{V}$ ,  $f_c=10.7\text{MHz}$ ,  $f_m=400\text{Hz}$ ,  $f=75\text{kHz dev.}$ )

Item	Symbol	Test Conditions	min	typ	max	Unit
Operating Current	$I_{CC(MAX)}$	$V_{in}=100\text{dB}\mu$ ; 2V supplied to pin-5; +150kHz-detuned	—	30.5	39.3	mA
Limiting Sensitivity	$V_{in(LIM)}$	Input level lower by 3dB than ( $V_{O(AF)}$ ) under 100dB $\mu$ of Input Voltage)	—	33.0	37.0	dB $\mu$
Recovered AF Voltage	$V_{O(AF)}$	$V_{in}=100\text{dB}\mu$	280	380	510	mV
Total Harmonic Distortion	THD	$V_{in}=100\text{dB}\mu$	—	0.01	0.08	%
Signal-to-Noise Ratio	S/N	$V_{in}=100\text{dB}\mu$	83	88	—	dB
AM Rejection	AMR	$V_{in}=100\text{dB}\mu$ , $f_m=1\text{kHz}$ , $Mod=30\%$	45	60	—	dB
Muting Attenuation	$M_{mute(ATT)}$	(Output Voltage under 100dB $\mu$ of $V_{in}$ and with pin-5 open)=0dB, 2V fed to pin-5 via 12k $\Omega$	83	100	—	dB
Muting Band Width	$BW_{(Mute)}$	the sum of plus- and minus-side $\Delta f_c$ 's for $V_{12}=1.4\text{V}$ , under 100dB $\mu$ of $V_{in}$ ;	60	100	160	kHz
Muting Sensitivity	$V_{in(Mute)}$	without Muting-Level control; Pin-16 open; $V_{12}=1.4\text{V}$	36	43	60	dB $\mu$
Muting-Sensitivity Control Range	$\Delta V_{in(Mute)}$	Max Input Level for Muting-Level Control	75	—	—	dB $\mu$
Meter Driving Voltage (1)	$V_{13-0}$	$V_{in}=0\text{dB}\mu$	—	0	—	V
Meter Driving Voltage (2)	$V_{13-70}$	$V_{in}=70\text{dB}\mu$	0.9	1.60	—	V
Meter Driving Voltage (3)	$V_{13-110}$	$V_{in}=110\text{dB}\mu$	4.5	5.5	—	V
Recovered AF Voltage Attenuation (for AM-band)	$V_{O(AF)}$	$V_{in}=100\text{dB}\mu$ ; Pin-15 open; 13V supplied to pin-15 via 4.7k $\Omega$	60	81	—	dB
Center-Meter Voltage (for AM-band)	$V_{CM(AM)}$	$V_{in}=100\text{dB}\mu$ ; +150kHz-detuned; the voltage difference of pins 7 and 10, with 13V supplied to pin-15	-30	+7	+30	mV

TEST CIRCUIT

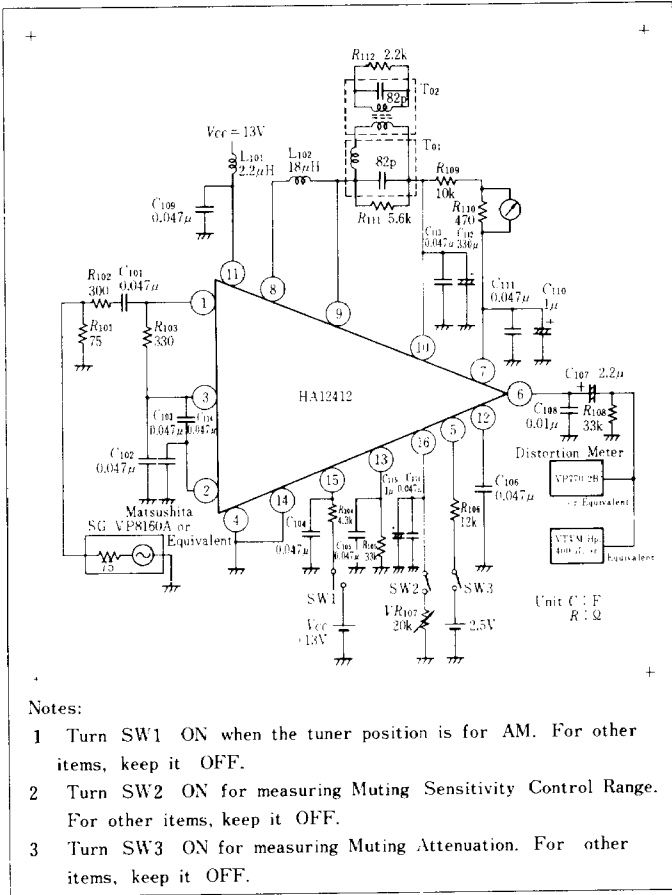

100dB typ and thus low-noise signal reception.

This IC features low DC offset voltage ( $V_6-V_{10}$ ) to minimize the pop noise cause by the DC offset when muting is turned ON under weak-input signal.

For prevention of the pop noise appearing at muting-ON when detuned, a gentle slope of audio muting characteristic is designed. This design offers an extra room for the external time-constant setup and satisfies both muting responses and pop noise level.

● Muting Control/Driver

Muting function starts at 43dB typ of input voltage when pin-16 is open (i.e.  $R_{107} = \infty$ ). Therefore by simply changing an external resistor at pin-16, the mute starting point can be adjusted up to 75dB $\mu$ . This feature enables low noise stereo reception.

Even when the mute starting point is set variable by controlling VR<sub>107</sub> (an external resistor at pin-16), the circuit design will not cause any temperature dependent problems.

● IF Amp Killer for AM band/Shorting Center-Meter

In an FM-AM tuner, the FM IF amp in operation may deteriorate S/N in AM reception, since an IF amp has high voltage gain of approximately 90dB.

In HA12412, simple feeding of AM block's supply voltage into pin-15 across R<sub>104</sub> makes the internal IF amp's killer start, to achieve low S/N AM band reception. Offset voltage generated by killing the IF amp is prevented by a built-in switch which shorts pins 7 and 10.

As mentioned above, good quality AM reception is performed with less number of parts.

As for the value of R<sub>104</sub>, an external resistor at pin-15, please refer to the following figure.

■ FUNCTION DESCRIPTIONS

The following functional descriptions has been achieved by giving careful consideration to the designing.

● FM IF Amp/Detector

Requirements for high performance FM tuners are satisfied by high S/N, low THD, and wide low-THD bandwidth.

The signal-to-noise ratio has reached 88dB typ; the HA12412 is designed for minimizing FM-demodulated noise (converted at the quadrature detector) and audible noise of the post stage audio amp.

Also, the optimized design in 90° phase-shift circuit has brought out low THD of 0.01% typ ( $V_{in}=100dB\mu$ ) and wide low-THD bandwidth of 10.7 MHz $\pm$ 120kHz (THD=0.1%).

In contrast to the conventional ones, this IC has removed the pin-9 IF output signal detection used for muting. The detection independent muting operation can eliminate much restriction in designing a phase shift transformer.

● Audio Muting

The muting control voltage from pin-12 delivers pin-5 the muting control signal and it works under weak-input signal or when detuned. This brings out large muting attenuation up to

■ R<sub>104</sub> (Resistor of Pin-15) vs. AM V<sub>CC</sub>

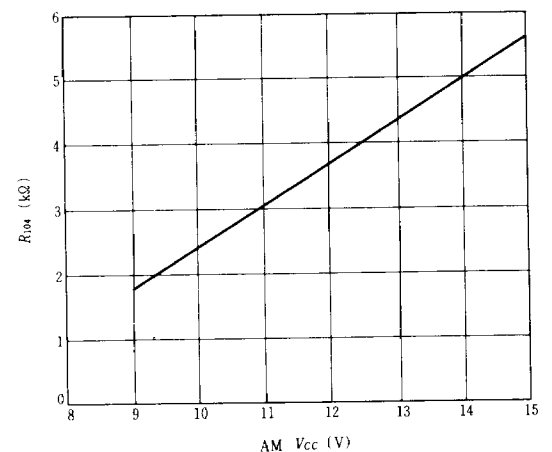

■ CAUTIONS

● 90° Phase Shift Transformer

Out of room temperature, caution must be taken about the phase shift transformer, as center-meter voltage and total harmonic distortion have large dependence upon temperature. The phase shift transformer shows satisfying characteristic in room temperature.

● Muting Control at Pin-16

Less  $C_{116}$  value than recommended ( $1\mu F$ ) may deteriorate AM-rejection around the muting starting point ( $V_{in(Mute)}$ ). Muting sensitivity is variable till the input level which saturates meter voltage. When muting sensitivity  $V_{in(Mute)}$  is set at a level over  $75dB\mu$  of input voltage, its dependence on temperature may enlarge.

● AFC Driving Voltage at Pin-7

$C_{110}$  value less than recommended may result in higher THD

around the operation range of detuned-frequency muting circuit.  $C_{110}$  value should be made largest within the range which will not deteriorate the muting response. This should be taken into consideration to give an optimum constant to  $C_{110}$ .

● Muting Control Voltage at Pin-12

Residual voltage of pin-12 muting control voltage does not depend upon the input level of pin-9 Quadrature Detector, thus enabling a phase shift transformer to be designed with less restriction.

● IF Amp Killer/Center-Meter Shorting for AM Band Reception (Pin-15)

As for  $R_{104}$  value, please refer to Fig. Larger  $R_{104}$  value than shown in this figure may increase the residual voltage between pins 7 and 10.

■ EXTERNAL COMPONENTS (Please See BLOCK DIAGRAM)

No.	Recommend- ed Value	Functions	Deteriorations		Notes
			Less than Recommended	More than Recommended	
R <sub>103</sub>	330	Impedance matching with the ceramic filter			
R <sub>104</sub>	4.3k	Limits the current flowing into pin-15	Increases the current into pin-15	Increases the center meter offset under AM band reception	The AM $V_{CC}$ value in Fig. should be taken into consideration to give $R_{104}$ value.
VR <sub>105</sub>	100k	Controls the sensitivity of meter deflection			Quasi-variable resistor
R <sub>106</sub>	12k	Along with $C_{107}$ , smooths the muting control voltage	Decreases the time constant	Increases the time constant	as a countermeasure of pop noise at muting-ON
VR <sub>107</sub>	20k	Adjusts the operating level of level muting			Quasi-variable resistor
R <sub>109</sub>	10k	Decides the AFC voltage and the muting band width when detuned	Decreases the AF AFC voltage. Increases the muting band width.	Increases the AF AFC voltage. Decreases the muting band width.	R <sub>109</sub> and $C_{110}$ compose LPF. $R_{109} \times C_{110}$ should be constant.
R <sub>110</sub>	470	Controls the sensitivity of the center meter.	Deteriorates the center meter sensitivity.	Delivers higher sensitivity of the center meter.	
R <sub>111</sub>	5.6k	Damps the resonance circuit at the primary side.	Increases THD.	Increases THD.	
R <sub>112</sub>	2.2k	Damps the resonance circuit at the secondary side.	Increases THD.	Increases THD.	
R <sub>113</sub>	47k	Discharges $C_{117}$ when muting switch is off.	Disables muting control.	Requires longer time to release from muting. *	*Resulted from increase of $C_{115}$ discharging time.

■ PHASE SHIFT TRANSFORMER (Bottom View)

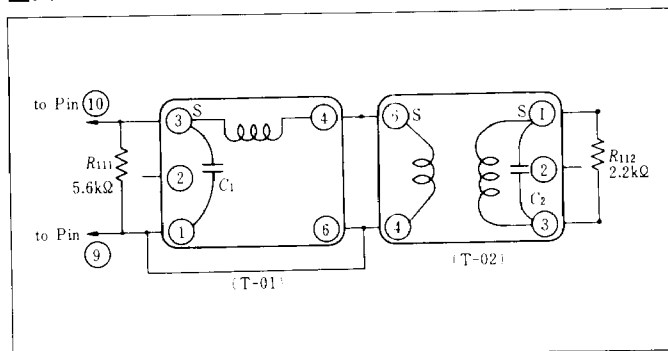

The following types of transformer are recommended.

	T-01	T-02	Note
Part No.	TKAEA-26394AUO (Toko)	TKAEA-26393AN (Toko)	Center-meter voltage ( $V_7 - V_{10}$ ) and THD show large dependence upon temperature.
Center Frequency	$f_c = 10.7MHz \pm 3\%$	$f_c = 10.7MHz \pm 3\%$	
Capacitance	$C_1 = 82pF$	$C_2 = 82pF$	
Unloaded Q	$Q_U = 58 \pm 20\%$	$Q_U = 55 \pm 20\%$	
	T-01	T-02	
Part No.	R-12-2479-A 41M10H (Mitsumi)	R-12-2480-A 41M10H (Mitsumi)	
Center Frequency	$f_c = 10.7MHz \pm 3\%$	$f_c = 10.7MHz \pm 3\%$	
Capacitance	$C_1 = 82pF \pm 10\%$	$C_2 = 82pF \pm 10\%$	
Unloaded Q	$Q_U = 58 \pm 15\%$	$Q_U = 58 \pm 15\%$	

PC-BOARD LAYOUT PATTERN

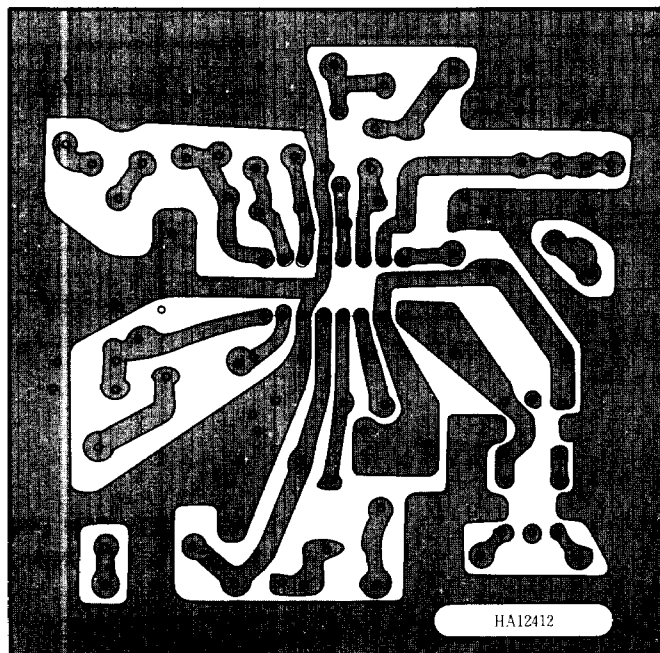

(Bottom View)

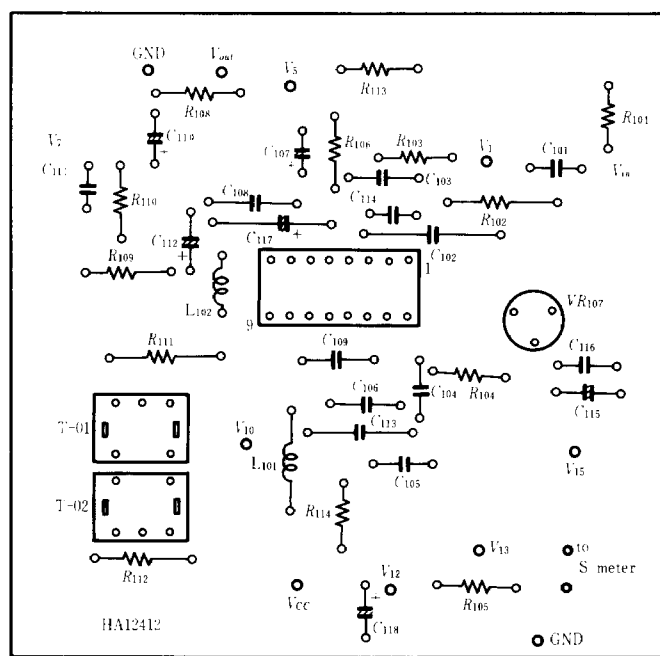

(Top View)

**SIGNAL-TO-NOISE RATIO, AF OUTPUT VOLTAGE AND AM REJECTION VS. INPUT VOLTAGE**

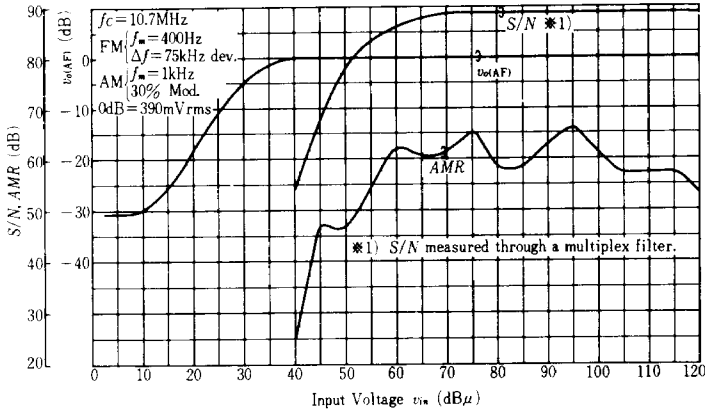

**PIN 12 AND 13 VOLTAGE VS. INPUT VOLTAGE**

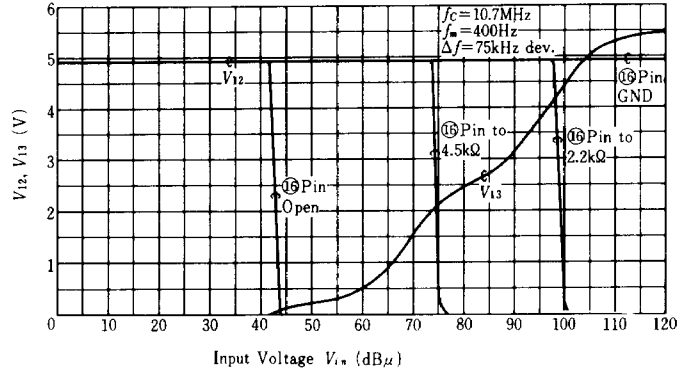

**TOTAL HARMONIC DISTORTION VS. INPUT VOLTAGE**

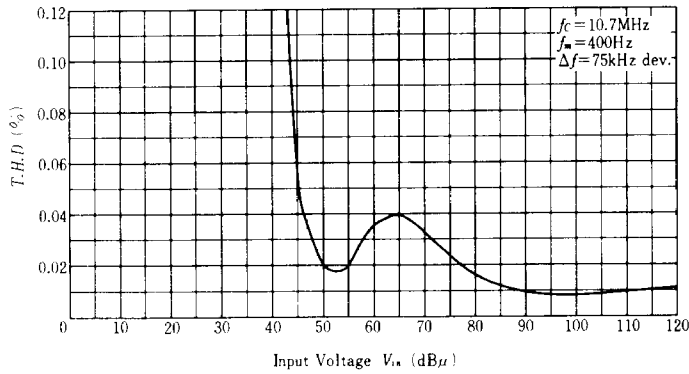

**VOLTAGE BETWEEN PINS 7 AND 10, AND PIN 12 VOLTAGE VS. DETUNING FREQUENCY**

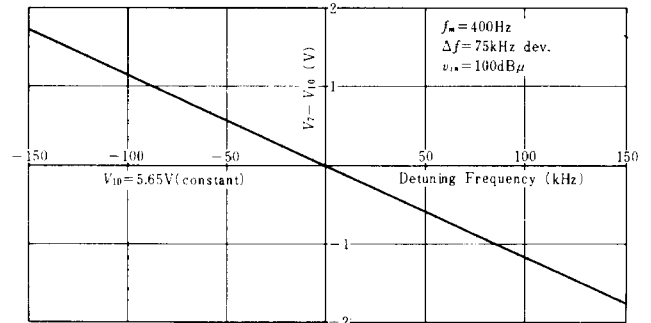

**PIN-12 VOLTAGE VS. DETUNING FREQUENCY**

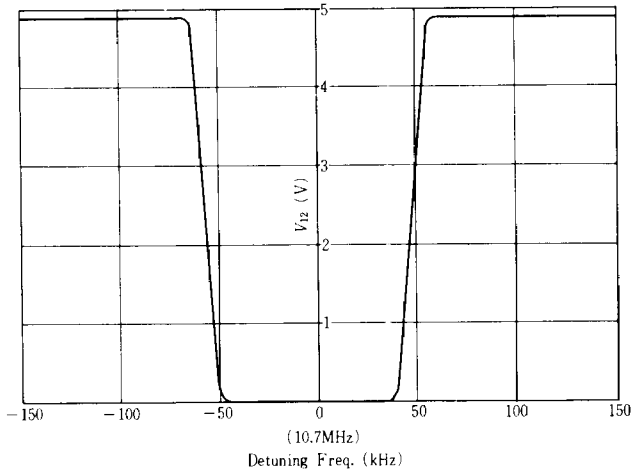

**TOTAL HARMONIC DISTORTION VS. DETUNING FREQUENCY**

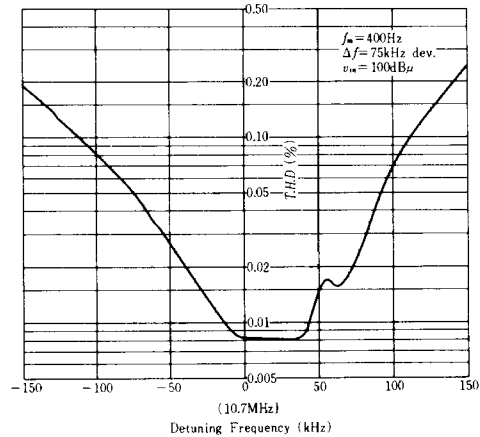

**AF OUTPUT VOLTAGE AND TOTAL HARMONIC DISTORTION VS. MODULATION FREQUENCY**

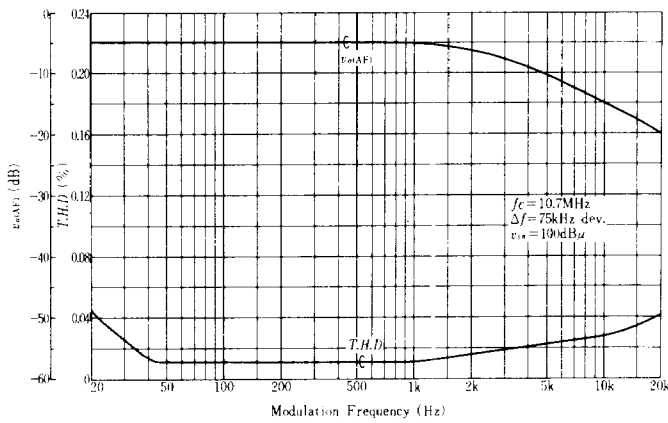

**VOLTAGE BETWEEN PINS 7 AND 10 VS. INPUT VOLTAGE**

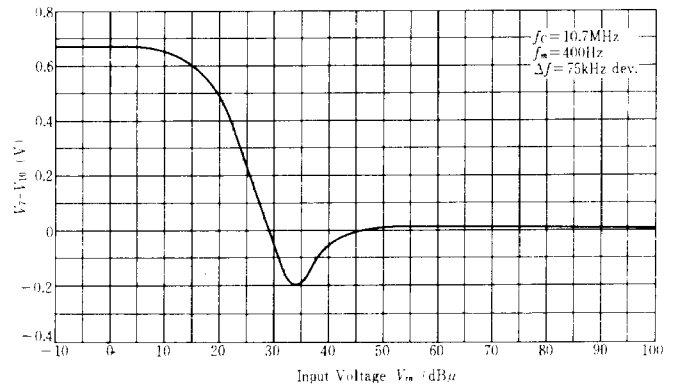

**AF OUTPUT VOLTAGE VS. PIN-5 APPLIED VOLTAGE**

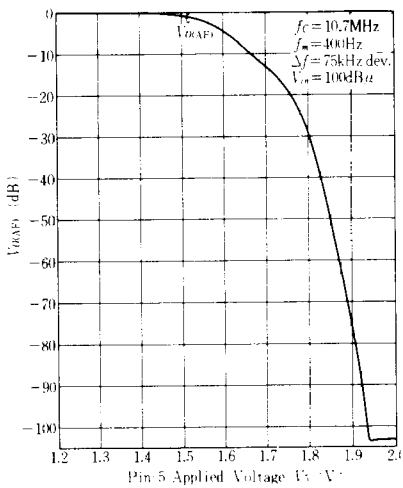

**AF OUTPUT VOLTAGE, AND VOLTAGE BETWEEN PINS 7 AND 10 VS. PIN-15 APPLIED VOLTAGE**

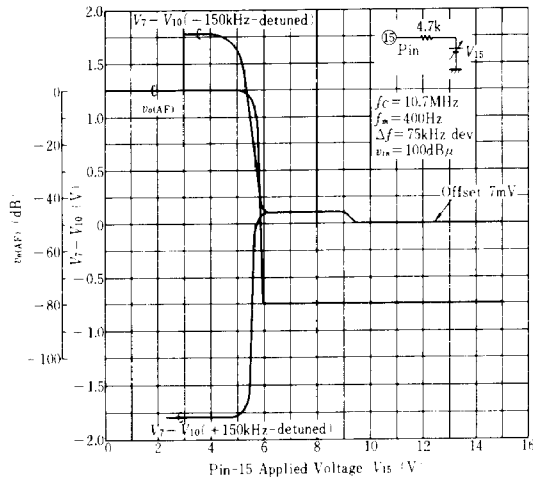

**OUTPUT VOLTAGE, MUTE ATTENUATION AND MAX. SUPPLY CURRENT VS. SUPPLY VOLTAGE**

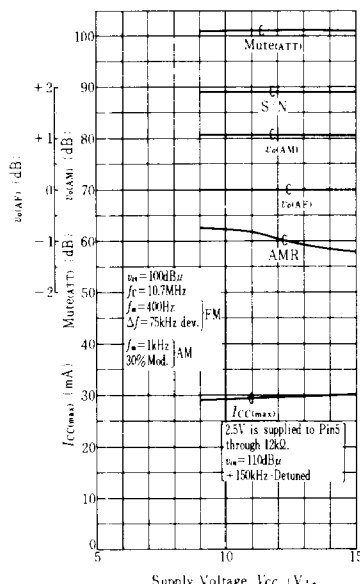

**MUTING BAND WIDTH, VOLTAGE BETWEEN PINS 7 AND 10, AND TOTAL HARMONIC DISTORTION VS. SUPPLY VOLTAGE**

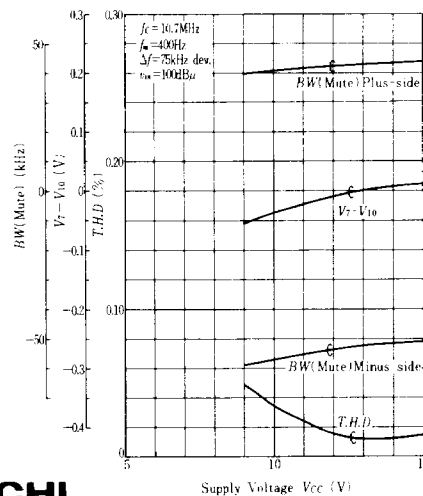

INPUT VOLTAGE VS. SUPPLY VOLTAGE

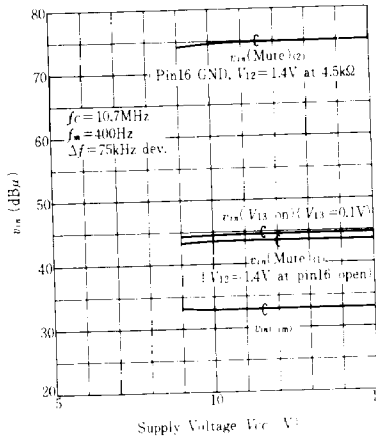

OUTPUT VOLTAGE, MUTE ATTENUATION, SIGNAL-TO-NOISE RATIO AND AM REJECTION VS. AMBIENT TEMPERATURE

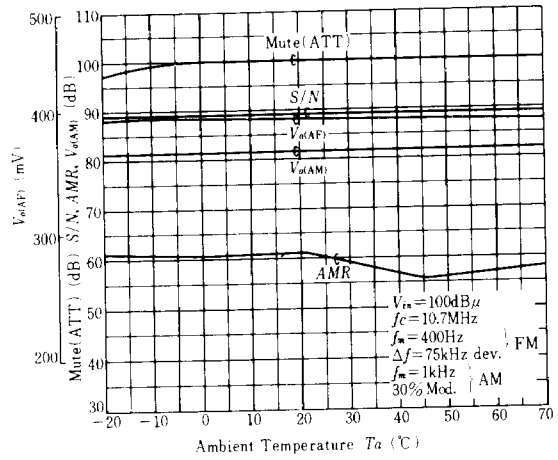

TOTAL HARMONIC DISTORTION AND MUTING BANDWIDTH VS. AMBIENT TEMPERATURE

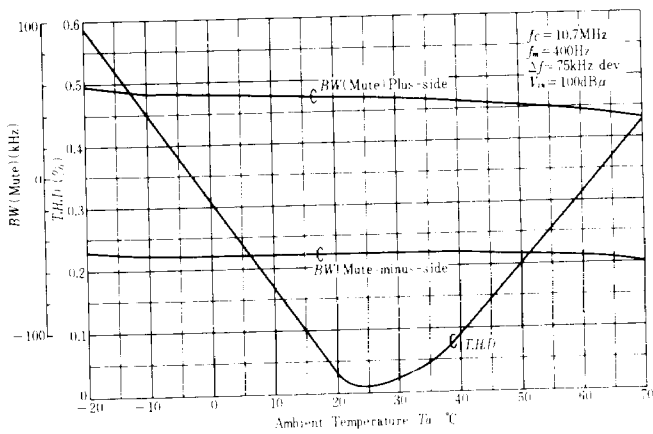

INPUT VOLTAGE VS. AMBIENT TEMPERATURE

