

Typical Applications

Prescaler for DC to Ku Band PLL Applications:

- Satellite Communication Systems
- Fiber Optic
- Pt-Pt and Pt-MPt Radios
- VSAT

Features

- Ultra Low SSB Phase Noise: -153 dBc/Hz
- Wide Bandwidth
- Output Power: -6 dBm
- Single DC Supply: +5V
- S8G SMT Package

Functional Diagram

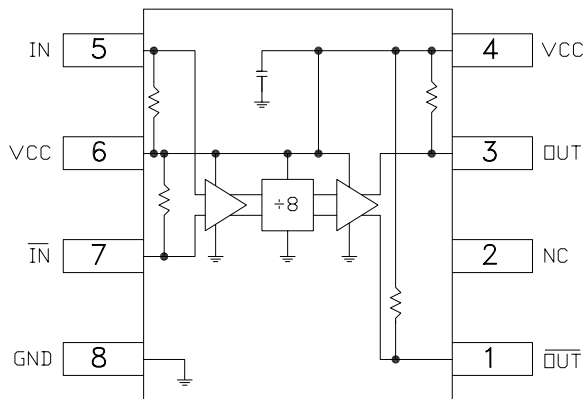

General Description

The HMC363S8G is a low noise Divide-by-8 Static Divider with InGaP GaAs HBT technology in an 8 lead surface mount plastic package. This device operates from DC (with a square wave input) to 12 GHz input frequency with a single +5.0V DC supply. The low additive SSB phase noise of -153 dBc/Hz at 100 kHz offset helps the user maintain good system noise performance.

Guaranteed Performance, Vcc= 5V, 25 Deg °C

Parameter	Conditions	Min.	Typ.	Max.	Units
Maximum Input Frequency		12	13		GHz
Minimum Input Frequency	Sine Wave Input. [1]		0.2	0.5	GHz
Input Power Range	Fin= 1 to 7 GHz	-15	>-20	+10	dBm
	Fin= 7 to 11 GHz	-10	>-15	+2	dBm
	Fin= 11 to 12 GHz	-5	>-8	0	dBm
Output Power	Fin= 12 GHz	-9	-6		dBm
Reverse Leakage	Both RF Outputs Terminated		65		dB
SSB Phase Noise (100 kHz offset)	Pin= 0 dBm, Fin= 6 GHz		-153		dBc/Hz
Output Transition Time	Pin= 0 dBm, Fout= 882 MHz		100		ps
Recommended Supply Voltage (Vcc)			5.0		Vdc
Supply Current (Icc)			70		mA

1. Divider will operate down to DC for square-wave input signal.

SMT GaAs HBT MMIC DIVIDE-BY-8, DC - 12.0 GHz

Input Sensitivity Window, $T = 25\text{ }^\circ\text{C}$

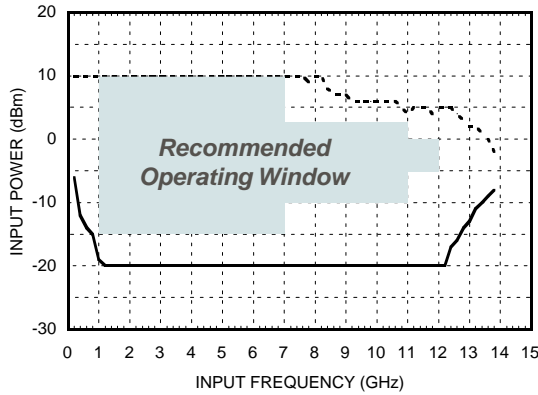

Input Sensitivity Window vs. Temperature

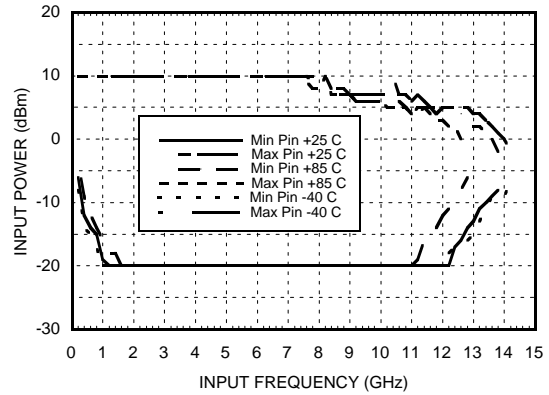

Output Power vs. Temperature

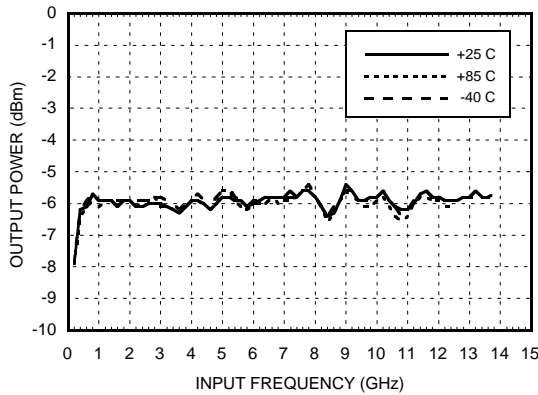

SSB Phase Noise

Performance, $P_{in} = 0\text{ dBm}$, $T = 25\text{ }^\circ\text{C}$

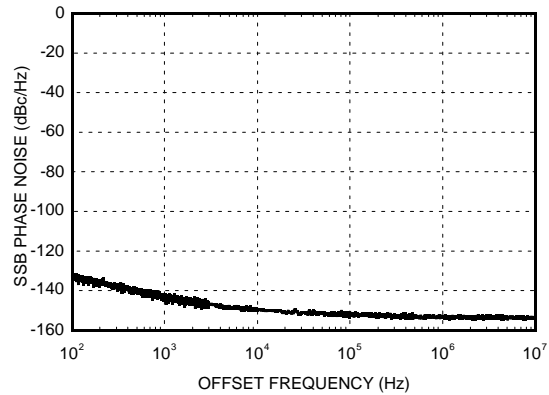

Output Harmonic

Content, $P_{in} = 0\text{ dBm}$, $T = 25\text{ }^\circ\text{C}$

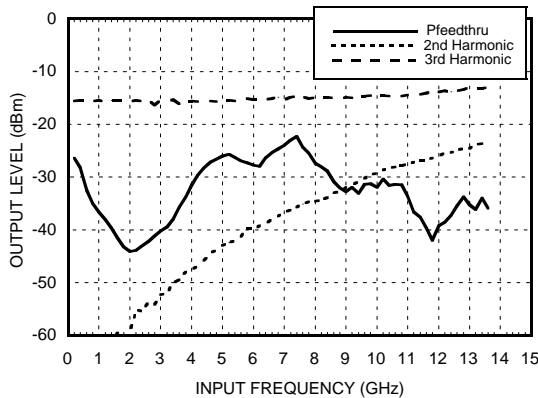

Reverse Leakage, $P_{in} = 0\text{ dBm}$, $T = 25\text{ }^\circ\text{C}$

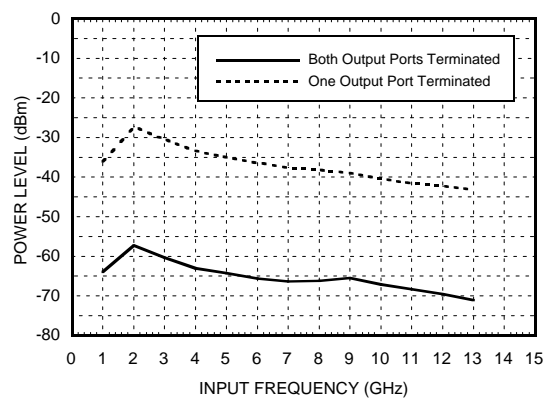

Output Voltage Waveform,
Pin= 0 dBm, Pout= 882 MHz, T= 25 °C

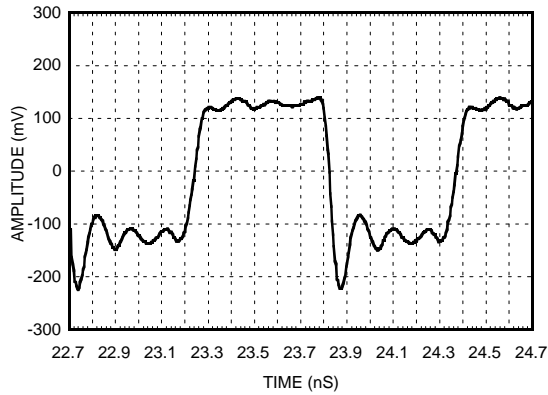

Absolute Maximum Ratings

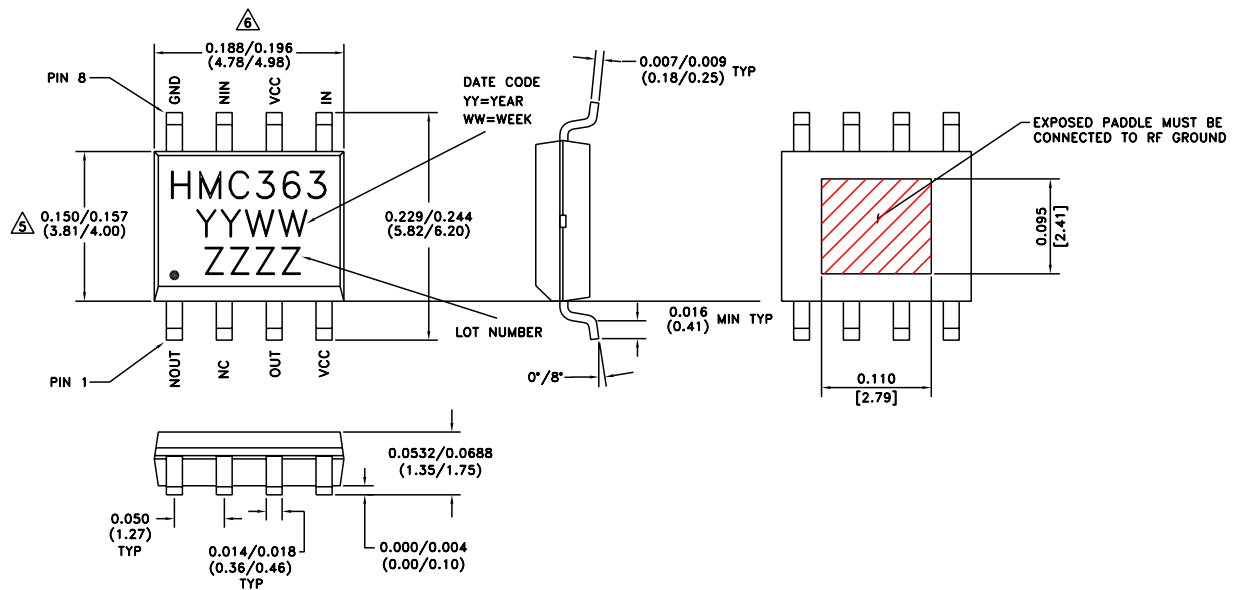

RF Input (Vcc = +5V)	+13 dBm
Vcc	+5.5V
VLogic	Vcc -1.6V to Vcc -1.2V
Storage Temperature	-65 to +150 deg C
Operating Temperature	-55 to +85 deg C

Pin Locations & Outline Drawing

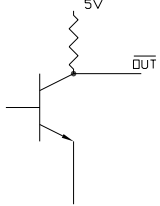
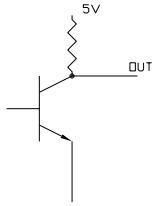
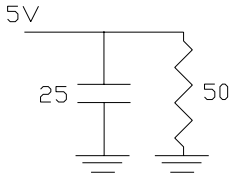
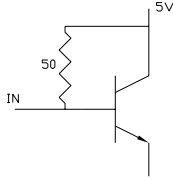
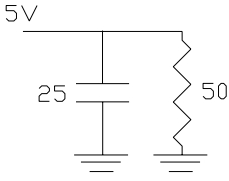
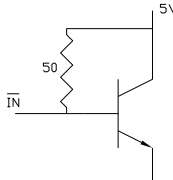

1. MATERIAL:
 - A. PACKAGE BODY - LOW STRESS INJECTION-MOLDED PLASTIC, SILICA & SILICONE INPREGNATED.
 - B. LEADFRAME MATERIAL: COPPER ALLOY
2. PLATING: LEAD-TIN SOLDER PLATE
3. DIMENSIONS ARE IN INCHES (MILLIMETERS)
4. CHARACTERS TO BE HELVETICA MEDIUM, .030 HIGH USING WHITE INK, LOCATED APPROX AS SHOWN
5. DIMENSION DOES NOT INCLUDE MOLDFLASH OF 0.15mm PER SIDE.
6. DIMENSION DOES NOT INCLUDE MOLDFLASH OF 0.25mm PER SIDE.

Pin Description

Pin Number	Function	Description	Interface Schematic
1	$\overline{\text{OUT}}$	Divided output 180° out of phase with pin 3.	
2	N/C	No connection.	
3	OUT	Divided Output.	
4	VCC	Supply voltage 5V ± 0.25V can be applied to pin 4 or 6.	
5	IN	RF Input must be DC blocked.	
6	VCC	Supply voltage 5V ± 0.25V can be applied to pin 4 or 6.	
7	$\overline{\text{IN}}$	RF Input 180° out of phase with pin 5 for differential operation. AC ground for single ended operation.	
8	GND	Ground: Backside of package has exposed metal ground slug which must be connected to ground.	

HMC363S8G Evaluation PCB

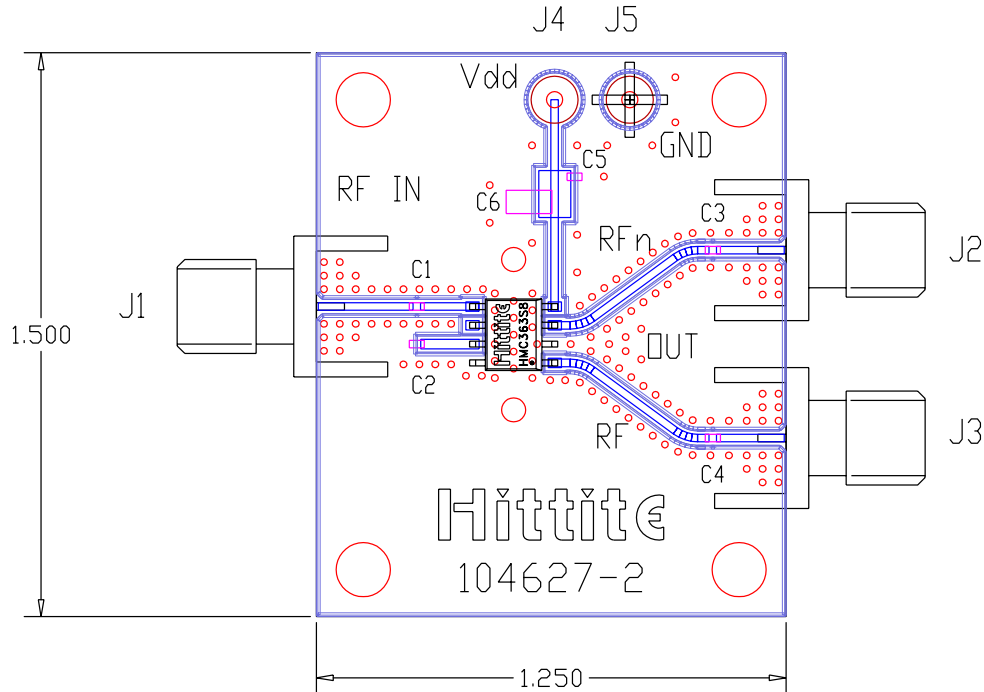

The circuit board used in the final application should use RF circuit design techniques. Signal lines should have 50 ohm impedance while the package ground leads and backside ground slug should be connected directly to the ground plane similar to that shown. A sufficient number of via holes should be used to connect the top and bottom ground planes. The evaluation circuit board shown is available from Hittite upon request. This evaluation board is designed for single ended input testing. J2 and J3 provide differential output signals.

Evaluation Circuit Board Layout Design Details

Item	Description
J1 - J3	PC Mount SMA RF Connector
C1 - C4	100 pF Capacitor, 0402 Pkg.
C5	1000 pF Capacitor, 0603 Pkg.
C6	10 μ F Tantalum Capacitor
U1	HMC363S8G Divide-by-8
PCB*	104627 Eval Board
* Circuit Board Material: Rogers 4350	

HMC363S8G Application Schematic

