

Typical Applications

Prescaler for DC to Ku Band PLL Applications:

- Satellite Communication Systems
- Fiber Optic
- Pt-Pt and Pt-MPt Radios
- VSAT

Features

- Ultra Low SSB Phase Noise: -145 dBc/Hz
- Wide Bandwidth
- Output Power: 4 dBm
- Single DC Supply: +5V
- Small Size: 0.686 x 1.295 mm

Functional Diagram

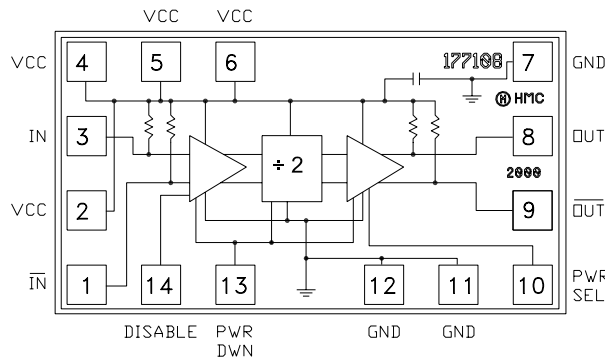

General Description

The HMC364 is a low noise Divide-by-2 Static Divider with InGaP GaAs HBT technology that has a small size of 0.686 mm x 1.295 mm. This device operates from DC (with a square wave input) to 13 GHz input frequency with a single +5.0V DC supply. The low additive SSB phase noise of -145 dBc/Hz at 100 kHz offset helps the user maintain good system noise performance.

Guaranteed Performance, Vcc= 5V, 25 Deg °C

Parameter	Conditions	Min.	Typ.	Max.	Units
Maximum Input Frequency		13	14		GHz
Minimum Input Frequency	Sine Wave Input. [1]		0.2	0.5	GHz
Input Power Range	Fin= 1 to 10 GHz	-15	>-20	+10	dBm
	Fin= 10 to 12 GHz	-10	>-15	+5	dBm
	Fin= 12 to 13 GHz	-4	>-8	+2	dBm
Output Power [2]	Fin= 6 GHz	1	4		dBm
	Fin= 9 GHz	-2			
	Fin= 11 GHz	-5			
	Fin= 13 GHz	-9			
Reverse Leakage	Both RF Outputs Terminated		40		dB
SSB Phase Noise (100 kHz offset)	Pin= 0 dBm, Fin= 6 GHz		-145		dBc/Hz
Output Transition Time	Pin= 0 dBm, Fout= 882 MHz		100		ps
Recommended Supply Voltage (Vcc)			5.0		Vdc
Supply Current (Icc) [2]			110		mA

1. Divider will operate down to DC for square-wave input signal.
2. When operating in high power mode (pin 10 connected to ground).

GaAs HBT MMIC DIVIDE-BY-2, DC - 13.0 GHz

Input Sensitivity Window, T= 25 °C

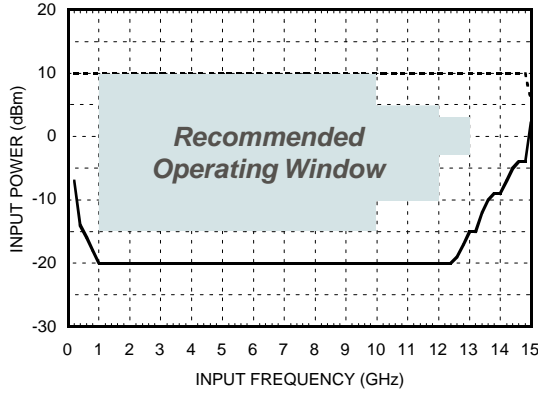

Input Sensitivity Window vs. Temperature

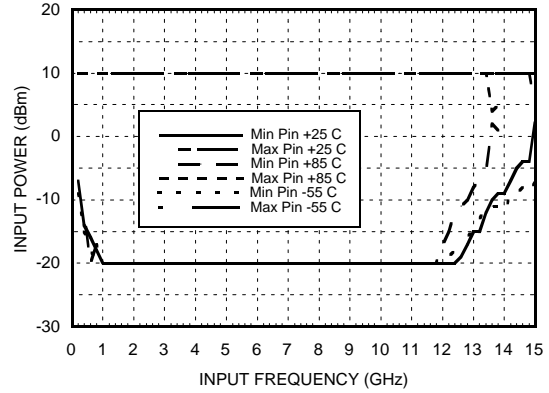

Output Power vs. Temperature

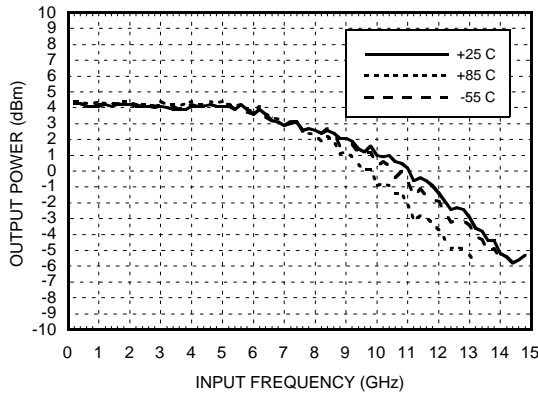

SSB Phase Noise Performance, Pin= 0 dBm, T= 25 °C

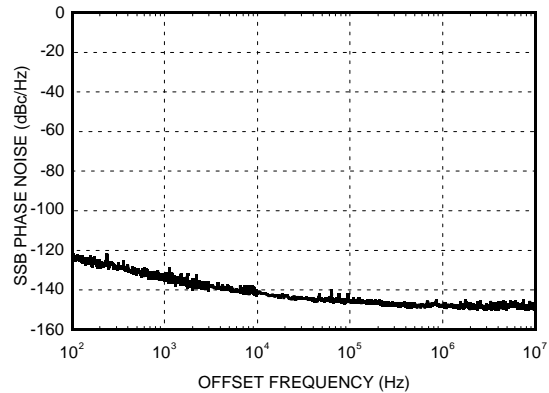

Output Harmonic Content, Pin= 0 dBm, T= 25 °C

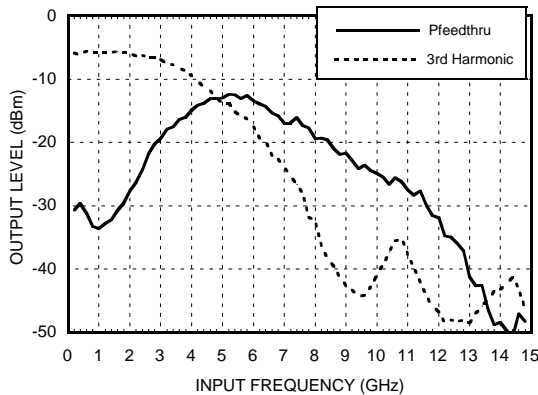

Reverse Leakage, Pin= 0 dBm, T= 25 °C

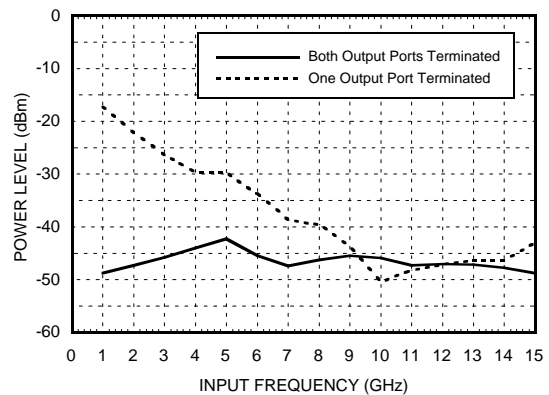

Output Voltage Waveform,
Pin= 0 dBm, Pout= 882 MHz, T= 25 °C

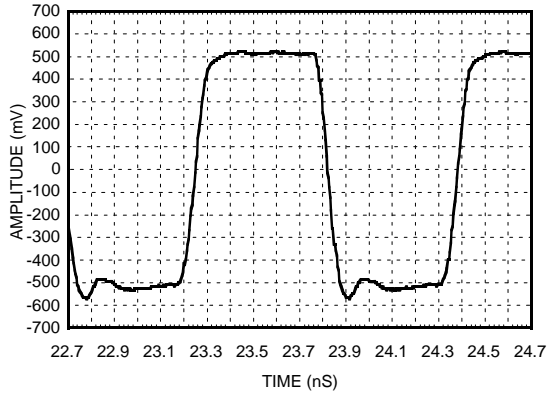

Absolute Maximum Ratings

RF Input (Vcc = +5V)	+13 dBm
Vcc	+5.5V
VLogic	Vcc -1.6V to Vcc -1.2V
Storage Temperature	-65 to +150 deg C
Operating Temperature	-55 to +85 deg C

Pad Locations & Outline Drawing

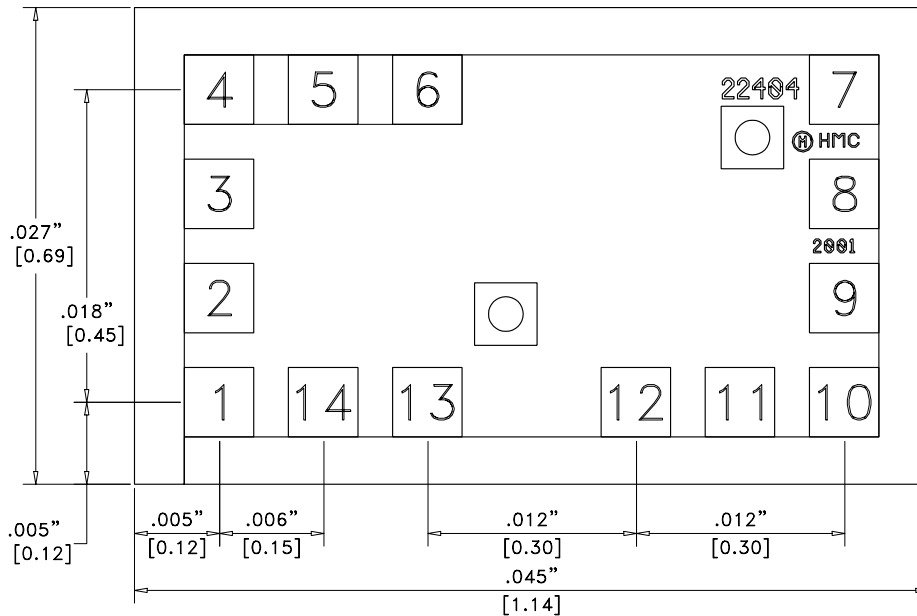

ALL DIMENSIONS IN INCHES (MILLIMETERS)
 ALL TOLERANCES ARE ± 0.001 (0.025)
 DIE THICKNESS IS 0.004 (0.100) BACKSIDE IS GROUND
 BOND PADS ARE 0.004 (0.100) SQUARE
 BOND PAD SPACING, CTR-CTR: 0.006 (0.150)
 BACKSIDE METALLIZATION: GOLD
 BOND PAD METALLIZATION: GOLD

Pad Description

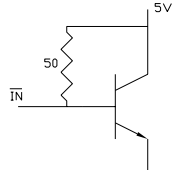
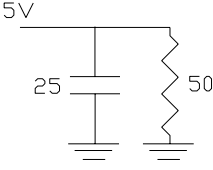
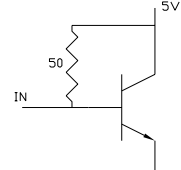
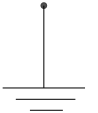
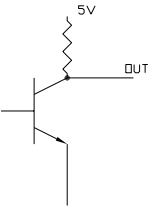
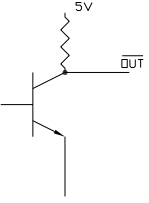
Pad Number	Function	Description	Interface Schematic
1	$\overline{\text{IN}}$	RF input 180° out of phase with pad 3 for differential operation. AC ground for single ended operation.	
2, 4, 5, 6	VCC	Supply Voltage 5V ±0.25V can be applied to pad 2, 4, 5, or 6.	
3	IN	RF input must be DC blocked.	
7, 11, 12	GND	Ground: These pads are grounded.	
8	OUT	Divided Output	
9	$\overline{\text{OUT}}$	Divided output 180° out of phase with pad 8.	

Pad Description (continued)

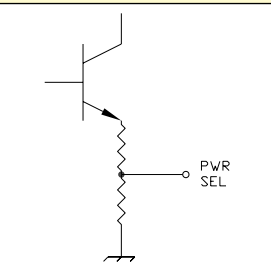
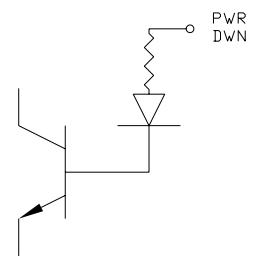
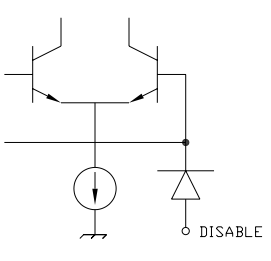
Pad Number	Function	Description	Interface Schematic
10	PWR SEL	In the low power mode, the power select pin is left floating. By grounding this pin, the output power is increased by approximately 6 dB.	
13	PWR DWN	The power down pin is grounded for normal operation. Applying 5 volts to this pin will power down this device.	
14	DISABLE	The disable pin is grounded for normal operation. Applying 5 volts to this pin will disable the input buffer amplifier.	

Truth Table

Function	Pin	5V	GND	Float
DISABLE	14	Output Off	Output On	X
PWR DWN	13	Power Down	Power Up	X
PWR SEL	10	X	High Power Output	Low Power Output

X = State not permitted.

Assembly Diagrams

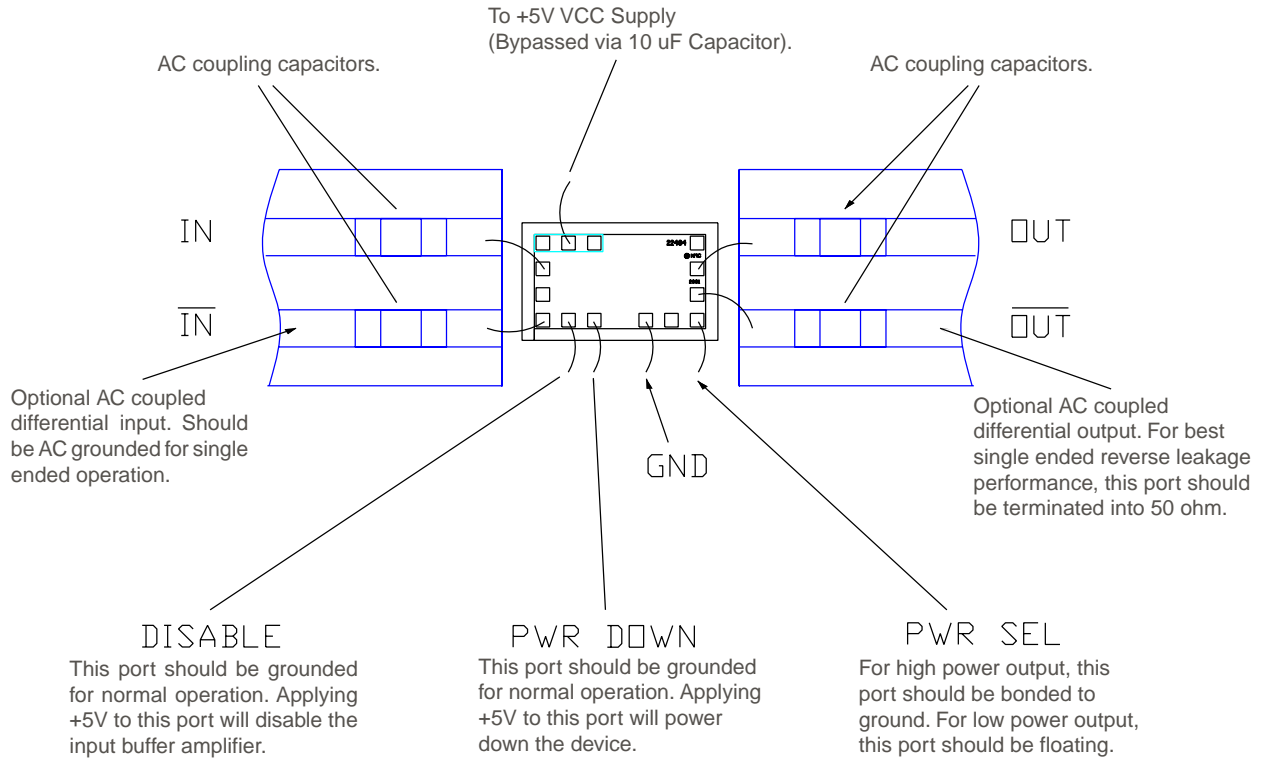

Handling Precautions

Follow these precautions to avoid permanent damage.

Cleanliness:

Handle the chips in a clean environment.
DO NOT attempt to clean the chip using liquid cleaning systems.

Static Sensitivity:

Follow ESD precautions to protect against $> \pm 250V$ ESD strikes (see page 8 - 2).

Transients:

Suppress instrument and bias supply transients while bias is applied.
Use shielded signal and bias cables to minimize inductive pick-up.

General Handling:

Handle the chip along the edges with a vacuum collet or with a sharp pair of bent tweezers.
The surface of the chip has fragile air bridges and should not be touched with vacuum collet, tweezers, or fingers.

Mounting

The chip is back-metallized and can be die mounted with AuSn eutectic preforms or with electrically conductive epoxy.
The mounting surface should be clean and flat.

Eutectic Die Attach:

A 80/20 gold tin preform is recommended with a work surface temperature of 255 deg. C and a tool temperature of 265 deg. C. When hot 90/10 nitrogen/hydrogen gas is applied, tool tip temperature should be 290 deg. C.
DO NOT expose the chip to a temperature greater than 320 deg. C for more than 20 seconds. No more than 3 seconds of scrubbing should be required for attachment.

Epoxy Die Attach:

Apply a minimum amount of epoxy to the mounting surface so that a thin epoxy fillet is observed around the perimeter of the chip once it is placed into position.
Cure epoxy per the manufacturer's schedule.

Wire Bonding

Ball or wedge bond with 0.025mm (1 mil) diameter pure gold wire. Ball bonds should be made with a force of 40-50 grams and wedge bonds at 18-22 grams. All bonds should be made with a nominal stage temperature of 150 deg. C. A minimum amount of ultrasonic energy should be applied to achieve reliable bonds. All bonds should be as short as possible, less than 12 mils (0.31 mm).

*GaAs HBT MMIC
DIVIDE-BY-2, DC - 13.0 GHz*

Notes: