

Cascadable Silicon Bipolar MMIC Amplifier

Technical Data

MSA-0711

Features

- **Cascadable 50 Ω Gain Block**
- **3 dB Bandwidth:**
DC to 1.9 GHz
- **12.0 dB Typical Gain at 1.0 GHz**
- **Unconditionally Stable ($k > 1$)**
- **Low Cost Surface Mount Plastic Package**
- **Tape-and-Reel Packaging Option Available⁽¹⁾**

Note:

1. Refer to PACKAGING section "Tape-and-Reel Packaging for Surface Mount Semiconductors".

Description

The MSA-0711 is a low cost silicon bipolar Monolithic Microwave Integrated Circuit (MMIC) housed in the surface mount plastic SOT-143 package. This MMIC is designed for use as a general purpose 50 Ω gain block. Typical applications include narrow and broad band IF and RF amplifiers in commercial and industrial applications.

The MSA-series is fabricated using HP's 10 GHz f_T , 25 GHz f_{MAX} , silicon bipolar MMIC process which uses nitride self-alignment, ion implantation, and gold metalli-

SOT-143 Package

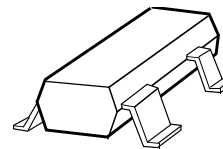

zation to achieve excellent performance, uniformity and reliability. The use of an external bias resistor for temperature and current stability also allows bias flexibility.

Typical Biasing Configuration

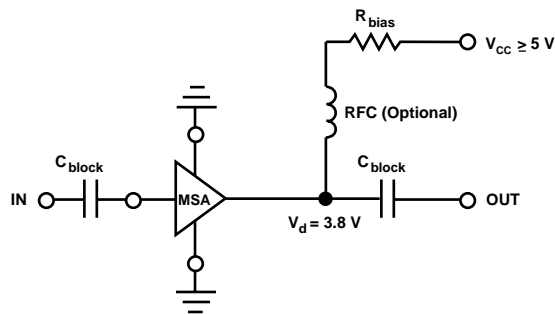

MSA-0711 Absolute Maximum Ratings

Parameter	Absolute Maximum ^[1]
Device Current	50 mA
Power Dissipation ^[2,3]	175 mW
RF Input Power	+13 dBm
Junction Temperature	150°C
Storage Temperature	-65 to 150°C

Thermal Resistance^[2,4]:

$$\theta_{jc} = 505^{\circ}\text{C/W}$$

Notes:

1. Permanent damage may occur if any of these limits are exceeded.
2. $T_{\text{CASE}} = 25^{\circ}\text{C}$.
3. Derate at 2.0 mW/°C for $T_{\text{C}} > 62^{\circ}\text{C}$.
4. See MEASUREMENTS section "Thermal Resistance" for more information.

Electrical Specifications^[1], $T_{\text{A}} = 25^{\circ}\text{C}$

Symbol	Parameters and Test Conditions: $I_{\text{d}} = 22 \text{ mA}$, $Z_{\text{o}} = 50 \Omega$	Units	Min.	Typ.	Max.
G_{P}	PowerGain ($ S_{21} ^2$) f = 0.1 GHz f = 1.0 GHz	dB	10.0	13.0 12.0	
ΔG_{P}	Gain Flatness f = 0.1 to 1.3 GHz	dB		± 0.8	
$f_{3 \text{ dB}}$	3 dB Bandwidth	GHz		3.2	
VSWR	Input VSWR f = 0.1 to 2.0 GHz			1.5:1	
	Output VSWR f = 0.1 to 2.0 GHz			1.5:1	
NF	50 Ω Noise Figure f = 1.0 GHz	dB		5.0	
$P_{1 \text{ dB}}$	Output Power at 1 dB Gain Compression f = 1.0 GHz	dBm		5.5	
IP_3	Third Order Intercept Point f = 1.0 GHz	dBm		18.0	
t_{D}	Group Delay f = 1.0 GHz	psec		145	
V_{d}	Device Voltage $T_{\text{C}} = 25^{\circ}\text{C}$	V	3.0	3.8	4.6
dV/dT	Device Voltage Temperature Coefficient	mV/°C		-7.0	

Note:

1. The recommended operating current range for this device is 15 to 30 mA. Typical performance as a function of current is on the following page.

Part Number Ordering Information

Part Number	No. of Devices	Container
MSA-0711-TR1	3000	7" Reel
MSA-0711-BLK	100	Antistatic Bag

For more information, see "Tape and Reel Packaging for Semiconductor Devices".

MSA-0711 Typical Scattering Parameters ($Z_0 = 50 \Omega$, $T_A = 25^\circ\text{C}$, $I_d = 22 \text{ mA}$)

Freq. GHz	S_{11}		S_{21}			S_{12}			S_{22}	
	Mag	Ang	dB	Mag	Ang	dB	Mag	Ang	Mag	Ang
0.1	.03	1	13.0	4.47	174	-18.6	.118	1	.19	-8
0.2	.04	1	12.9	4.42	168	-18.5	.119	2	.19	-18
0.4	.04	-4	12.8	4.38	157	-18.4	.120	4	.19	-36
0.6	.05	-19	12.6	4.28	146	-18.1	.125	9	.19	-52
0.8	.07	-32	12.3	4.14	135	-17.7	.130	10	.20	-68
1.0	.08	-44	12.0	3.99	123	-17.4	.135	12	.19	-82
1.5	.13	-88	10.9	3.52	98	-16.1	.157	13	.19	-113
2.0	.18	-130	9.8	3.08	75	-15.2	.173	8	.18	-138
2.5	.25	-155	8.6	2.68	61	-14.7	.184	9	.18	-151
3.0	.32	-178	7.2	2.30	42	-14.7	.185	5	.17	-158
3.5	.38	165	5.8	1.96	26	-14.8	.181	3	.17	-150
4.0	.42	152	4.5	1.68	12	-14.7	.184	1	.20	-142

A model for this device is available in the DEVICE MODELS section.

Typical Performance, $T_A = 25^\circ\text{C}$

(unless otherwise noted)

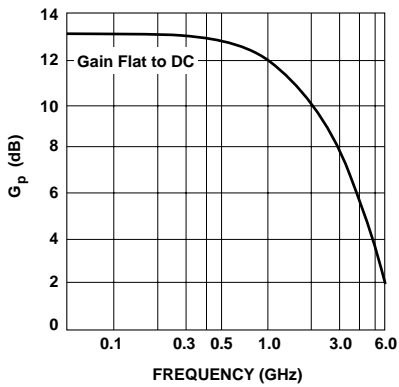

Figure 1. Power Gain vs. Frequency, $I_d = 22 \text{ mA}$.

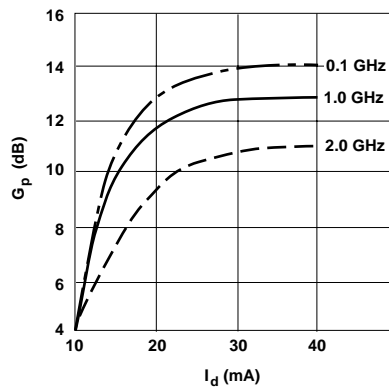

Figure 2. Power Gain vs. Current.

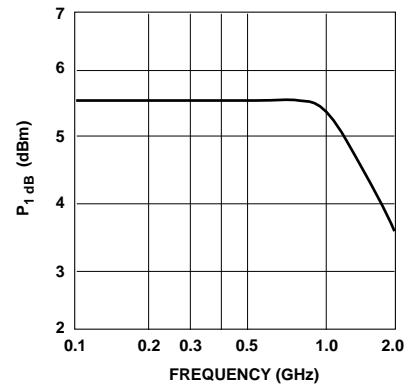

Figure 3. Output Power at 1 dB Gain Compression vs. Frequency, $I_d = 22 \text{ mA}$.

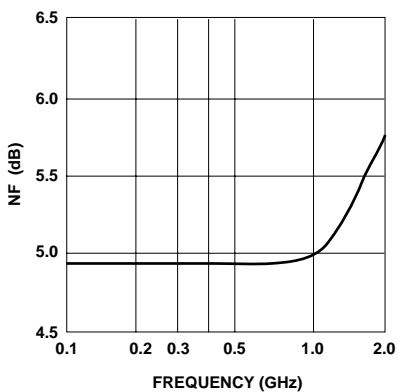
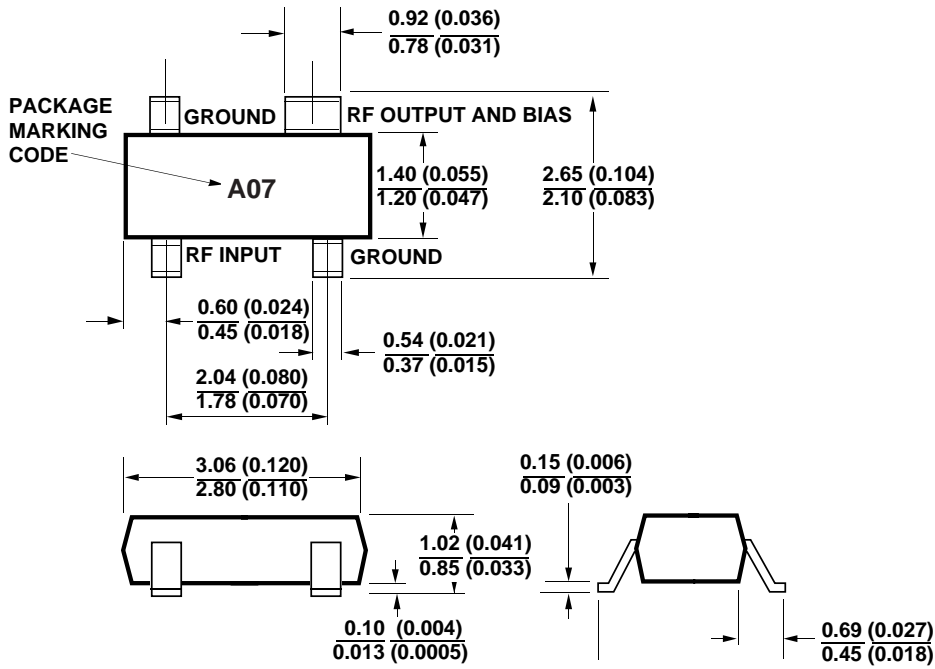

Figure 4. Noise Figure vs. Frequency, $I_d = 22 \text{ mA}$.

SOT-143 Package Dimensions



DIMENSIONS ARE IN MILLIMETERS (INCHES)