

# Cascadable Silicon Bipolar MMIC Amplifier

## Technical Data

### MSA-0670

#### Features

- **Cascadable 50  $\Omega$  Gain Block**
- **Low Operating Voltage:**  
3.5 V Typical  $V_d$
- **3 dB Bandwidth:**  
DC to 1.0 GHz
- **High Gain:**  
19.5 dB Typical at 0.5 GHz
- **Low Noise Figure:**  
2.8 dB Typical at 0.5 GHz
- **Hermetic Gold-ceramic  
Microstrip Package**

#### Description

The MSA-0670 is a high performance silicon bipolar Monolithic Microwave Integrated Circuit (MMIC) housed in a hermetic,

high reliability package. This MMIC is designed for use as a general purpose 50  $\Omega$  gain block. Typical applications include narrow and broad band IF and RF amplifiers in industrial and military applications.

The MSA-series is fabricated using HP's 10 GHz  $f_T$ , 25 GHz  $f_{MAX}$ , silicon bipolar MMIC process which uses nitride self-alignment, ion implantation, and gold metallization to achieve excellent performance, uniformity and reliability. The use of an external bias resistor for temperature and current stability also allows bias flexibility.

#### 70 mil Package

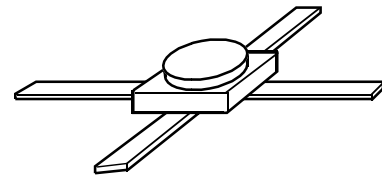

#### Typical Biasing Configuration

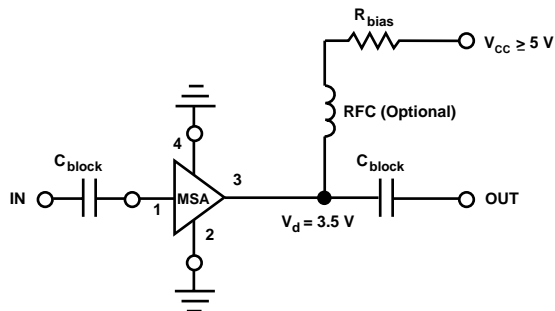

## MSA-0670 Absolute Maximum Ratings

Parameter	Absolute Maximum <sup>[1]</sup>
Device Current	50 mA
Power Dissipation <sup>[2,3]</sup>	200 mW
RF Input Power	+13 dBm
Junction Temperature	200°C
Storage Temperature	-65 to 200°C

**Thermal Resistance<sup>[2,4]</sup>:**

$$\theta_{jc} = 130^{\circ}\text{C/W}$$

### Notes:

1. Permanent damage may occur if any of these limits are exceeded.
2.  $T_{\text{CASE}} = 25^{\circ}\text{C}$ .
3. Derate at  $7.7 \text{ mW/}^{\circ}\text{C}$  for  $T_{\text{C}} > 174^{\circ}\text{C}$ .
4. The small spot size of this technique results in a higher, though more accurate determination of  $\theta_{jc}$  than do alternate methods. See MEASUREMENTS section "Thermal Resistance" for more information.

## Electrical Specifications<sup>[1]</sup>, $T_{\text{A}} = 25^{\circ}\text{C}$

Symbol	Parameters and Test Conditions: $I_{\text{d}} = 16 \text{ mA}$ , $Z_{\text{o}} = 50 \Omega$	Units	Min.	Typ.	Max.
$G_{\text{P}}$	Power Gain ( $ S_{21} ^2$ ) $f = 0.1 \text{ GHz}$	dB	19.0	20.5	22.0
$\Delta G_{\text{P}}$	Gain Flatness $f = 0.1 \text{ to } 0.6 \text{ GHz}$	dB		$\pm 0.7$	$\pm 1.0$
$f_{3 \text{ dB}}$	3 dB Bandwidth	GHz		1.0	
VSWR	Input VSWR $f = 0.1 \text{ to } 1.5 \text{ GHz}$			1.9:1	
	Output VSWR $f = 0.1 \text{ to } 1.5 \text{ GHz}$			1.8:1	
NF	50 $\Omega$ Noise Figure $f = 0.5 \text{ GHz}$	dB		2.8	4.0
$P_{1 \text{ dB}}$	Output Power at 1 dB Gain Compression $f = 0.5 \text{ GHz}$	dBm		2.0	
$\text{IP}_3$	Third Order Intercept Point $f = 0.5 \text{ GHz}$	dBm		14.5	
$t_{\text{D}}$	Group Delay $f = 0.5 \text{ GHz}$	psec		200	
$V_{\text{d}}$	Device Voltage	V	3.1	3.5	3.9
$\text{dV/dT}$	Device Voltage Temperature Coefficient	mV/ $^{\circ}\text{C}$		-8.0	

### Note:

1. The recommended operating current range for this device is 12 to 30 mA. Typical performance as a function of current is on the following page.

### MSA-0670 Typical Scattering Parameters ( $Z_0 = 50 \Omega$ , $T_A = 25^\circ\text{C}$ , $I_d = 16 \text{ mA}$ )

Freq. GHz	S <sub>11</sub>		S <sub>21</sub>			S <sub>12</sub>			S <sub>22</sub>		k
	Mag	Ang	dB	Mag	Ang	dB	Mag	Ang	Mag	Ang	
0.1	.05	-147	20.5	10.62	172	-23.3	.068	4	.05	-69	1.05
0.2	.07	-134	20.4	10.41	164	-23.0	.070	8	.09	-92	1.04
0.3	.09	-126	20.1	10.16	156	-22.6	.074	12	.13	-104	1.02
0.4	.11	-123	19.9	9.85	148	-22.4	.076	14	.16	-113	1.00
0.5	.13	-123	19.6	9.50	141	-22.0	.079	26	.20	-121	0.99
0.6	.15	-123	19.2	9.09	135	-21.3	.082	18	.22	-128	0.97
0.8	.19	-126	17.4	8.28	122	-20.7	.093	22	.25	-141	0.94
1.0	.24	-129	16.5	7.46	110	-19.8	.103	22	.27	-154	0.92
1.5	.31	-141	15.2	5.76	87	-18.2	.124	23	.27	-176	0.91
2.0	.38	-157	13.0	4.47	68	-17.2	.138	19	.24	166	0.94
2.5	.42	-167	11.1	3.59	57	-16.7	.146	20	.21	158	1.01
3.0	.46	178	9.5	2.97	45	-16.4	.152	16	.17	156	1.07
3.5	.48	173	7.9	2.49	33	-16.2	.155	11	.14	163	1.15
4.0	.48	164	6.6	2.13	22	-16.1	.156	9	.11	-175	1.27
4.5	.48	155	5.5	1.87	13	-15.9	.161	5	.11	-154	1.35
5.0	.48	143	4.5	1.67	3	-15.8	.163	3	.14	-141	1.46

**Note:**

1. A model for this device is available in the DEVICE MODELS section.

### Typical Performance, $T_A = 25^\circ\text{C}$

(unless otherwise noted)

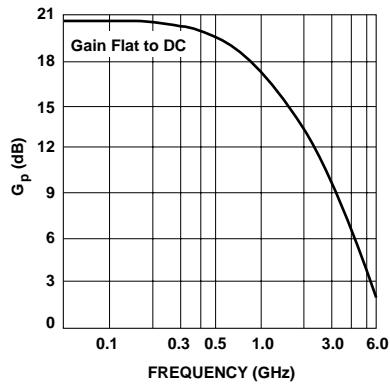

**Figure 1. Typical Power Gain vs. Frequency,  $T_A = 25^\circ\text{C}$ ,  $I_d = 16 \text{ mA}$ .**

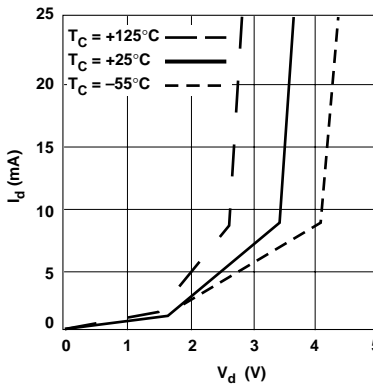

**Figure 2. Device Current vs. Voltage.**

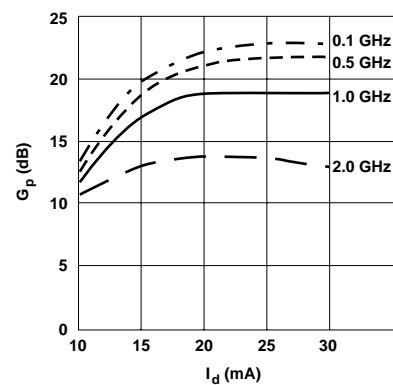

**Figure 3. Power Gain vs. Current.**

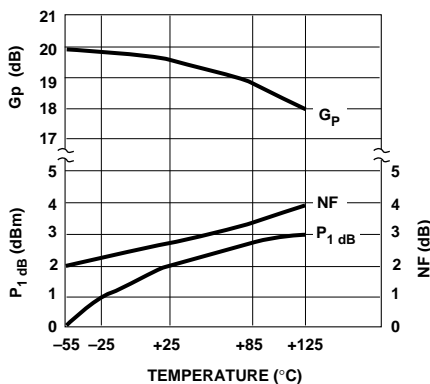

**Figure 4. Output Power at 1 dB Gain Compression, NF and Power Gain vs. Case Temperature,  $f = 0.5 \text{ GHz}$ ,  $I_d = 16 \text{ mA}$ .**

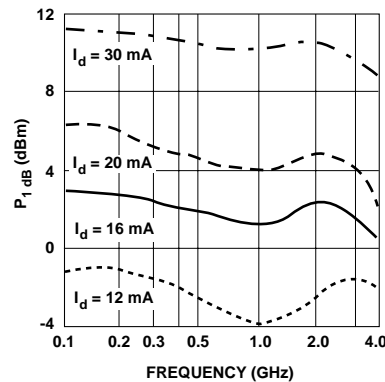

**Figure 5. Output Power at 1 dB Gain Compression vs. Frequency.**

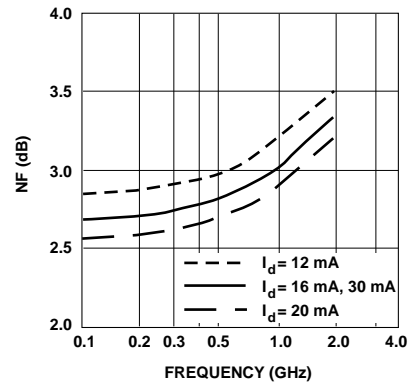

**Figure 6. Noise Figure vs. Frequency.**

# 70 mil Package Dimensions

