

Silicon Bipolar RFIC 900 MHz Driver Amplifier

Technical Data

Features

- RFIC Medium Power Amplifier
- 150-960 MHz Operating Range
- +22 dBm Typ. P_{1dB} , +23 dBm Typ. P_{sat} @ 900 MHz
- 50 dB Typ. Power Control Range
- 6 V, 160 mA Operation
- S0-8 Surface Mount Package with Improved Heatsinking

Applications

- Driver Amplifier for GSM Cellular Handsets
- Driver or Output Stage for 900 MHz ISM Band Transmitters
- Driver or Output Stage for Transmitters Operating in the 150-960 MHz Range

Functional Block Diagram

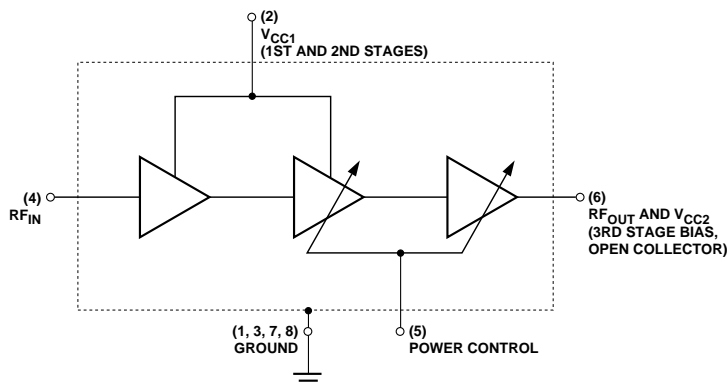

Plastic S0-8 Package

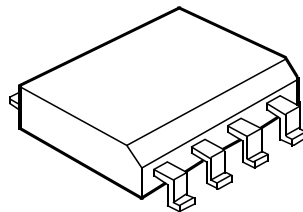

Pin Configuration

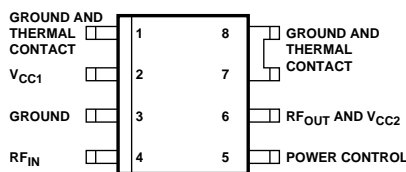

HPMX-3002

Description

Hewlett-Packard's HPMX-3002 is a silicon microwave monolithic integrated circuit driver amplifier housed in a S0-8 surface mount plastic package. It operates over the 150 - 960 MHz frequency range, and at 900 MHz it produces +23 dBm of saturated output power, has 30 dB of small signal gain and a 50 dB power control range. The amplifier has a well-matched input, and an open collector output which provides good linearity and efficiency and is easy to externally match to 50 Ω for optimal power output.

This device is well suited as a driver amplifier for European GSM (Global System for Mobile communications) portable and mobile telephone systems, or as the output stage for other low cost applications such as 900 MHz ISM band spread-spectrum.

The HPMX-3002 is fabricated with Hewlett-Packard's 15 GHz f_t ISOSAT-II process, which combines stepper lithography, ion implantation, self-alignment techniques, and gold metallization to produce RFICs with superior performance, uniformity and reliability.

HPMX-3002 Absolute Maximum Ratings

Symbol	Parameter	Units	Absolute Maximum ^[1]
P_{diss}	Power Dissipation ^[2,3]	mW	1400
P_{in}	Input Power	dBm	+5
$V_{CC}^{[1]}$	Supply Voltage	V	8
$V_{CC}^{[2]}$	Supply Voltage, 3rd Stage	V	12
V_{cont}	Control Voltage	V	5
T_j	Junction Temperature	°C	150
T_{STG}	Storage Temperature	°C	-65 to 150

Thermal Resistance^[2]:

$$\Theta_{jc} = 66^\circ\text{C/W}$$

Notes:

1. Operation of this device above any one of these parameters may cause permanent damage.

2. $T_c = 25^\circ\text{C}$ (T_c is defined to be the temperature at the ends of pin 7 where it contacts the circuit board).

3. Derate at $15.2\text{ mW}/^\circ\text{C}$ for $T_c > 58^\circ\text{C}$.

HPMX-3002 Guaranteed Electrical Parameters, $T_C = 37^\circ\text{C}$, $Z_0 = 50\ \Omega$

$V_{CC1} = 4.5\text{ V}$, $V_{CC2} = 6\text{ V}$, $P_{IN} = -6\text{ dBm}$ @ 900 MHz, output matched for maximum power

$I_{CC1} = 65\text{ mA nom.}$, $I_{CC2} = 95\text{ mA nom.}$ set by V_{cont} (pin 5) = 2.2 V (unless otherwise noted).

Symbol	Parameters and Test Conditions	Units	Min.	Typ.	Max.
P_{out}	Output Power $P_{IN} = -6\text{ dBm}$, $f = 900\text{ MHz}$	dBm	22	23	
PCR	Power Control Range $f = 900\text{ MHz}$, $V_{cont} = 0\text{ to }2.2\text{ V}$	dBm	40	50	
I_{CC1}	Driver Stages Current $V_{CC1} = 4.5\text{ V}$	mA		65	75
I_{CC2}	Output Stage Current $V_{CC2} = 6\text{ V}$	mA		95	120

HPMX-3002 Summary Characterization Information, $T_C = 37^\circ\text{C}$, $Z_0 = 50\ \Omega$

$V_{CC1} = 4.5\text{ V}$, $V_{CC2} = 6\text{ V}$, $P_{in} = -6\text{ dBm}$ @ 900 MHz, output matched for maximum power

$I_{CC1} = 65\text{ mA nom.}$, $I_{CC2} = 95\text{ mA nom.}$ set by V_{cont} (pin 5) = 2.2 V (unless otherwise noted).

Symbol	Parameters and Test Conditions	Units	Typ.
P_{1dB}	Output Power at 1 dB Gain Compression P_{IN} set for $P_{out} = P_{1dB}$, $f = 900\text{ MHz}$	dBm	22
G_{SS}	Small Signal Gain $f = 900\text{ MHz}$, $P_{in} = -18\text{ dBm}$	dB	32
IP_3	Third Order Intercept Point $f_1 = 900\text{ MHz}$, $f_2 = 901\text{ MHz}$ P_{out} per tone = 12 dBm	dBm	29
IP_5	Fifth Order Intercept Point $f_1 = 900\text{ MHz}$, $f_2 = 901\text{ MHz}$ P_{out} per tone = 12 dBm	dBm	24
NF	Noise Figure	dB	9.5
VSWR _{in}	Input Voltage Standing Wave Ratio	-	1.5:1
I_{cont}	Control Current $V_{cont} = 0\text{ to }2.2\text{ V}$	mA	2.5

HPMX-3002 Pin Description

Ground (pins 1,3,7,8):

This RFIC is ground sensitive. A short path to ground with minimal parasitics must be provided on all ground leads to prevent stability problems. The PC board should be 0.032" or less in thickness. Multiple vias should be placed near the ground leads. Failure to properly ground this device can lead to positive return gain and possible stability problems. We suggest performing a stability analysis using the device s parameters and a description of the inductance of your ground path. A recommended board layout is shown on the final page of this data sheet. Pins 7 and 8 also provide the primary thermal path for heatsinking the device.

V_{CC1} (pin 2):

This pin provides the DC bias for the amplifier driver stages, and

has an operating range of 4.5 to 6 V (5 V nominal). It should be bypassed close to RFIC body using a 1000 pF capacitor.

RF_{in} (pin 4):

The impedance of this RFIC is well matched to 50 Ω from 100 MHz to 1100 MHz. Normally, no additional impedance matching is required. S-parameters are provided should the designer need to "fine tune" the input match. Pin 4 must be AC coupled to generator (1000 pF typ. blocking capacitor). The nominal drive level is -6 dBm, and under normal operating conditions should not exceed 0 dBm.

Control (pin 5):

Applying a DC voltage to this pin adjusts the gain of the last 2 stages of the RFIC over a 50 dB range. Pin 5 has an operational

range of 0 to 2.5 V. The power control function is designed for operation in the 800 - 1000 MHz frequency range, and decreases in adjustment capability at lower frequencies – refer to the performance graphs (figure 3).

RF_{out} and V_{CC2} (Pin 6):

Pin 6 connects to the open collector of the output stage. A power match is required at this pin. The typical match for operation between 800 and 1000 MHz consists of a shunt L (8 nH typ.) and a series C (27 pF typ.), with the series C also serving as the blocking capacitor. The s parameter data should be used to generate matches for other frequency bands.

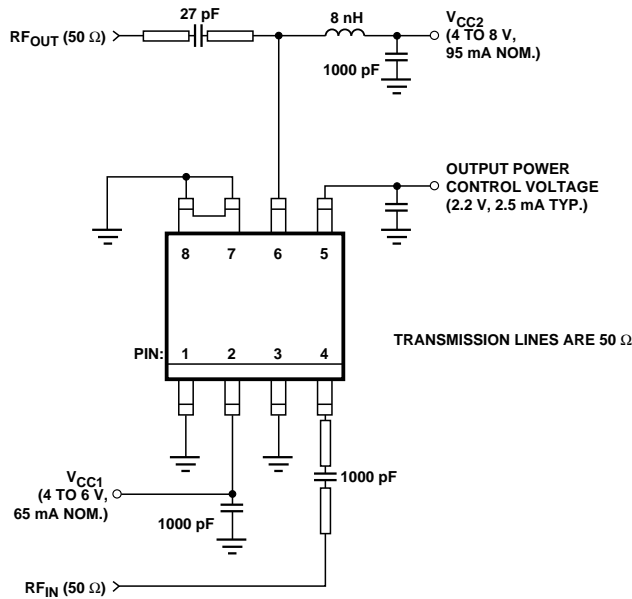

Figure 1. HPMX-3002 Typical 900 MHz Amplifier Use.

HPMX-3002 Typical Performance, $T_C = 37^\circ\text{C}, Z_0 = 50 \Omega$

$P_{in} = -6 \text{ dBm @ } 900 \text{ MHz}, V_{CC1} = 4.5 \text{ V}, V_{CC2} = 6 \text{ V}, V_{control} = 2.2 \text{ V}, I_{CC1} = 66 \text{ mA}, I_{CC2} = 95 \text{ mA nom.}$
 Output matched for max. P_{out} @ 900 MHz (unless otherwise noted)

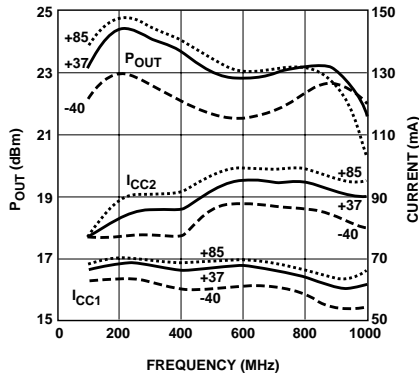

Figure 2. HPMX-3002 Output Power and Current vs. Frequency and Temperature.

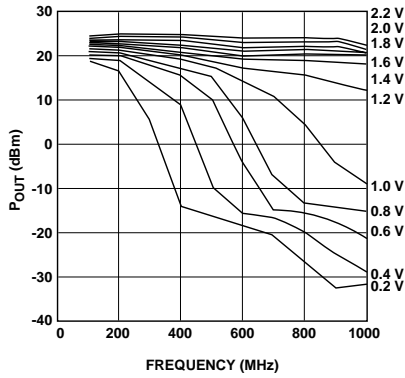

Figure 3. HPMX-3002 Output Power vs. Frequency and Control Voltage.

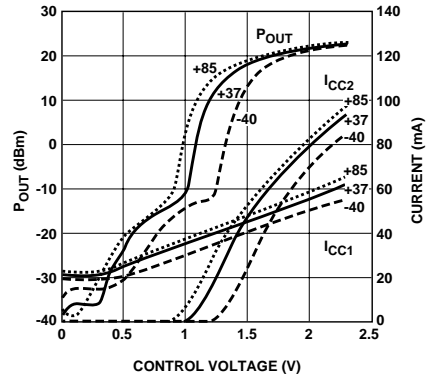

Figure 4. HPMX-3002 Output Power and Current vs. Control Voltage and Temperature.

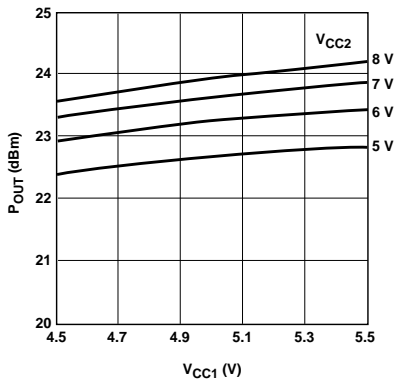

Figure 5. HPMX-3002 Output Power vs. Supply Voltage.

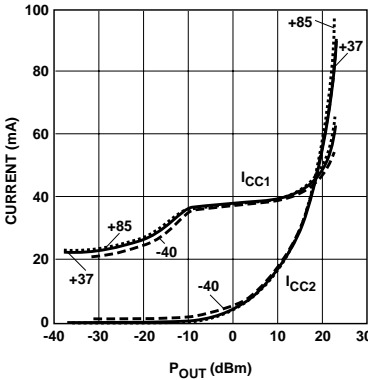

Figure 6. HPMX-3002 Current vs. Output Power and Temperature.

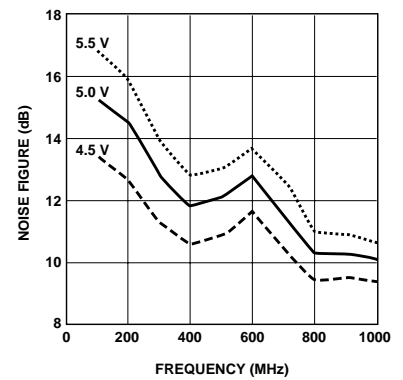

Figure 7. HPMX-3002 Noise Figure vs. Frequency and V_{CC1} .

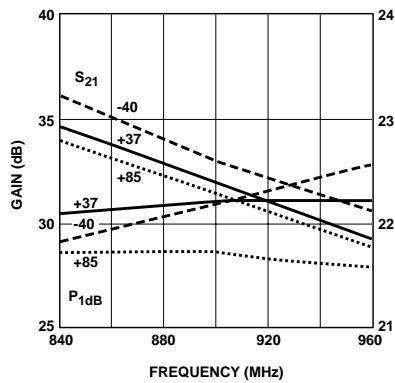

Figure 8. HPMX-3002 one dB Compressed Power and Small Signal Gain vs. Frequency and Temperature.

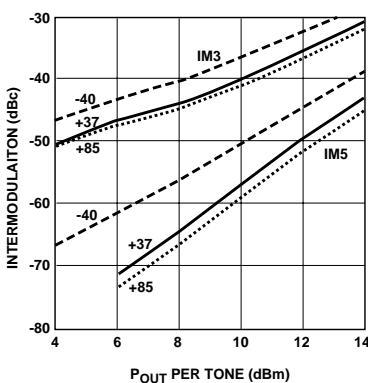

Figure 9. HPMX-3002 Intermodulation Distortion vs. Output Power and Temperature with $V_{control} = 2.0 \text{ V}$.

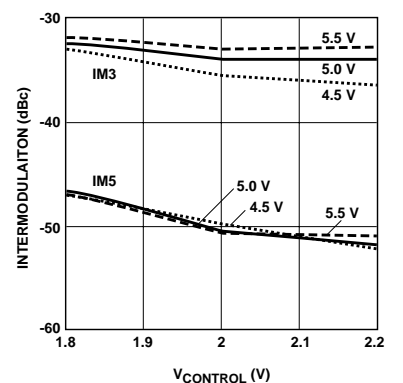

Figure 10. HPMX-3002 Intermodulation Distortion vs. Control Voltage and V_{CC1} for P_{out} per tone = 12 dBm.

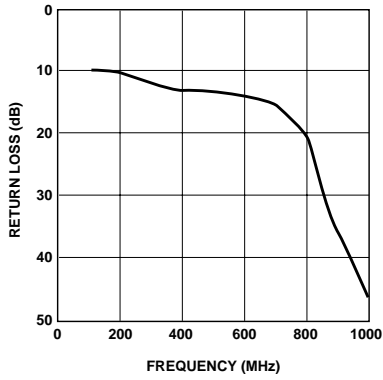

Figure 11. HPMX-3002 Input Return Loss vs. Frequency.

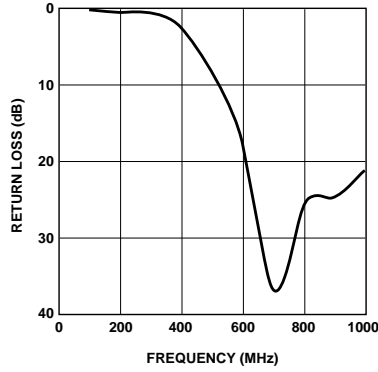

Figure 12. HPMX-3002 Output Return Loss vs. Frequency.

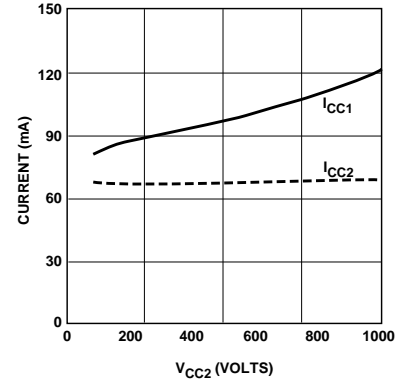

Figure 13. HPMX-3002 Stage Current vs. Supply Voltage with $V_{CC1} = 4.5$ V.

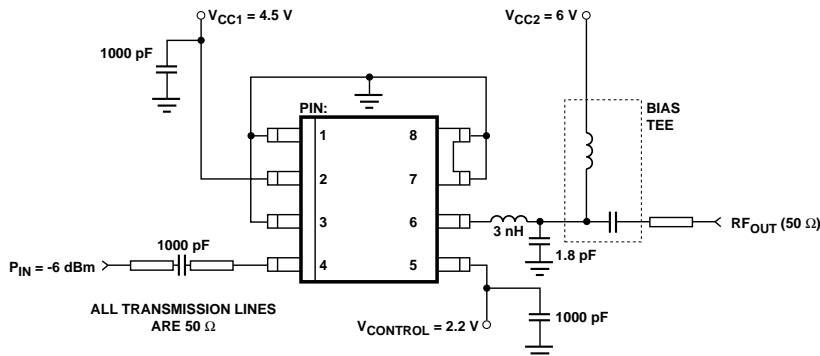

Figure 14. HPMX-3002 Test Circuit Configuration.

HPMX-3002 Typical Scattering Parameters, $T_C = 37^\circ\text{C}$, $Z_O = 50\ \Omega$ $V_{\text{control}} = 1.6\ \text{V}$
 $V_{\text{CC1}} = 4.5\ \text{V}$, $V_{\text{CC2}} = 6\ \text{V}$

Freq GHz	S ₁₁		dB	S ₂₁		dB	S ₁₂		S ₂₂		k
	Mag	Ang		Mag	Ang		Mag	Ang	Mag	Ang	
0.10	0.33	151	42.89	139.44	-138	-60.00	0.001	143	0.91	-25	0.77
0.20	0.34	92	44.16	161.44	143	-53.98	0.002	152	0.75	-53	0.82
0.30	0.31	51	42.95	140.50	98	-53.98	0.002	146	0.65	-67	1.10
0.40	0.31	18	42.06	126.79	63	-47.96	0.004	148	0.65	-76	0.77
0.50	0.29	-14	41.91	124.61	29	-44.44	0.006	141	0.73	-89	0.65
0.60	0.23	-52	42.12	127.67	-10	-40.92	0.009	143	0.85	-107	0.62
0.70	0.09	-117	41.62	120.47	-60	-38.42	0.012	138	0.88	-136	0.73
0.80	0.06	66	38.19	81.23	-106	-37.08	0.014	135	0.65	-162	0.84
0.90	0.16	42	34.23	51.44	-144	-35.92	0.016	131	0.41	-179	0.94
1.00	0.19	11	29.87	31.15	-169	-33.98	0.020	130	0.31	-170	1.04
1.10	0.21	6	26.42	20.93	-165	-32.40	0.024	127	0.25	-164	1.14

HPMX-3002 Typical Scattering Parameters, $T_C = 37^\circ\text{C}$, $Z_O = 50\ \Omega$ $V_{\text{control}} = 2.0\ \text{V}$
 $V_{\text{CC1}} = 4.5\ \text{V}$, $V_{\text{CC2}} = 6\ \text{V}$

Freq GHz	S ₁₁		dB	S ₂₁		dB	S ₁₂		S ₂₂		k
	Mag	Ang		Mag	Ang		Mag	Ang	Mag	Ang	
0.10	0.33	143	45.90	197.18	-158	-60.00	0.001	153	0.85	-31	0.85
0.20	0.31	83	45.15	180.94	128	-60.00	0.001	99	0.63	-56	1.78
0.30	0.28	43	43.46	148.88	88	-53.98	0.002	142	0.56	-65	1.26
0.40	0.27	11	42.43	132.22	55	47.96	0.004	138	0.60	-74	0.87
0.50	0.25	-21	42.15	128.14	22	-44.44	0.006	147	0.70	-88	0.67
0.60	0.19	-63	42.13	127.82	-17	-41.94	0.008	143	0.80	-108	0.61
0.70	0.05	-144	41.26	115.62	-64	-39.17	0.011	135	0.81	-138	0.73
0.80	0.09	61	37.86	78.15	-107	-37.72	0.013	135	0.59	-161	0.86
0.90	0.17	38	34.07	50.54	-144	-35.92	0.016	131	0.39	-178	0.95
1.00	0.19	12	29.89	31.23	-168	-33.98	0.020	132	0.30	-169	1.04
1.10	0.21	6	26.54	21.22	166	-32.40	0.024	127	0.24	-164	1.14

HPMX-3002 Typical Scattering Parameters, $T_C = 37^\circ\text{C}$, $Z_0 = 50\ \Omega$ $V_{\text{control}} = 2.2\text{V}$
 $V_{\text{CC1}} = 4.5\text{V}$, $V_{\text{CC2}} = 6\text{V}$

Freq GHz	S_{11}		S_{21}			S_{12}			S_{22}		k
	Mag	Ang	dB	Mag	Ang	dB	Mag	Ang	Mag	Ang	
0.10	0.26	122	46.64	214.70	160	-60.00	0.001	111	0.58	-30	1.70
0.20	0.18	67	43.80	154.92	99	-60.00	0.001	133	0.49	-33	2.53
0.30	0.15	30	41.76	122.46	65	-53.98	0.002	139	0.52	-40	1.64
0.40	0.12	-1	40.36	104.17	38	-50.46	0.003	149	0.59	-52	1.22
0.50	0.08	-30	39.64	95.89	6	-44.44	0.006	148	0.66	-68	0.79
0.60	0.02	-112	39.17	90.91	-29	-41.94	0.008	142	0.71	-89	0.70
0.70	0.13	92	38.03	79.70	-71	-40.00	0.010	137	0.65	-114	0.75
0.80	0.19	51	35.15	57.23	-109	-37.72	0.013	135	0.50	-131	0.88
0.90	0.23	34	32.04	39.99	-142	-35.92	0.016	134	0.34	-143	0.99
1.00	0.24	11	28.44	26.42	-168	-34.43	0.019	132	0.29	-139	1.11
1.10	0.24	4	25.49	18.82	166	-32.77	0.023	129	0.34	-137	1.15

Part Number Ordering Information

Part Number	Option	No. of Devices	Container
HPMX-3002	-	100	Tube
HPMX-3002	#T10	1000	Reel

Package Dimensions S0-8 Package

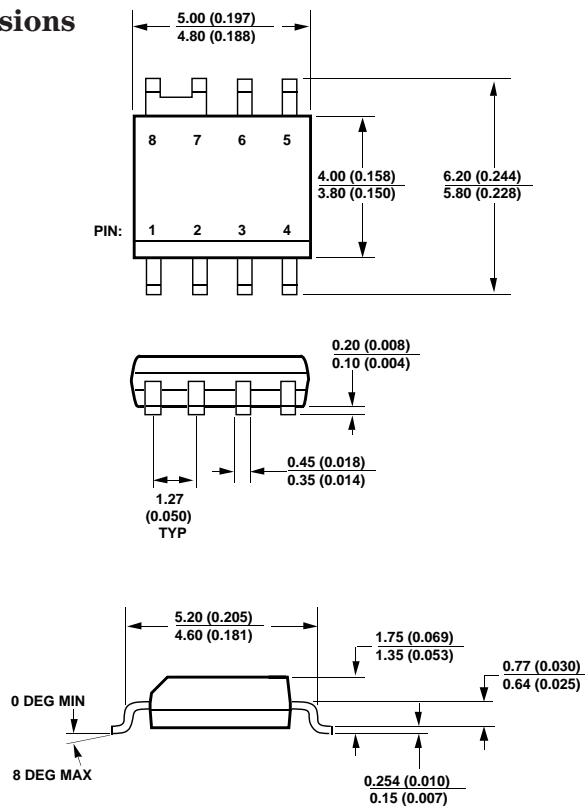

NOTE: DIMENSIONS ARE IN MILLIMETERS (INCHES).

HPMX-3002 Test Board Layout

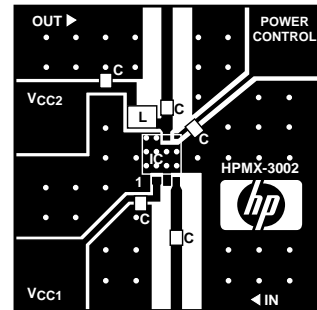
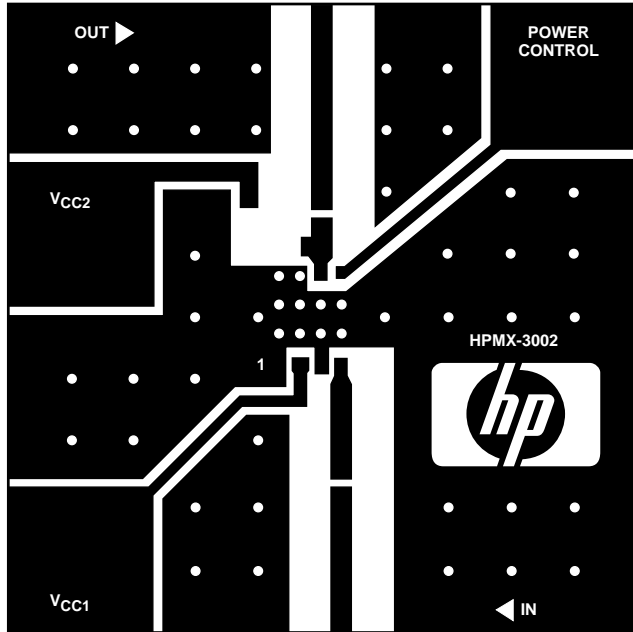

Finished board size: 1.5" x 1.5" x 1/32"
Material: 1/32" epoxy/fiberglass, 1 oz.
copper, both sides, tin/lead coating,
both sides.

Note: "." marks indicate drilling
locations for plated-through via holes
to the groundplane on the bottom
side of the board.

Board layed out for coil-craft #AO3T
8 nH spring-coil inductor.