

# 20 mm (0.8 inch) Seven Segment Displays

## Technical Data

**HDSP-340X Series**  
**HDSP-390X Series**  
**HDSP-420X Series**  
**HDSP-860X Series**  
**HDSP-N15X Series**

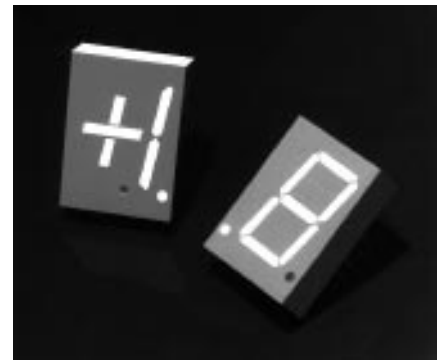
### Features

- **Industry Standard Size**
- **Industry Standard Pinout**  
15.24 mm (0.6 in.) DIP Leads on 2.54 mm (0.1 in.) Centers
- **Choice of Colors**  
Red, AlGaAs Red, High Efficiency Red, Yellow, Green
- **Excellent Appearance**  
Evenly Lighted Segments  
Mitered Corners on Segments  
Gray Package Gives Optimum Contrast  
± 50° Viewing Angle
- **Design Flexibility**  
Common Anode or Common Cathode  
Left and Right Hand Decimal Points  
± 1. Overflow Character
- **Categorized for Luminous Intensity**  
Yellow and Green Categorized

- for Color  
Use of Like Categories Yields a Uniform Display
- **High Light Output**
- **High Peak Current**
- **Excellent for Long Digit String Multiplexing Intensity and Color Selection Option**  
See Intensity and Color Selected Displays Data Sheet
- **Sunlight Viewable AlGaAs**

### Description

The 20 mm (0.8 inch) LED seven segment displays are designed for viewing distances up to 10 metres (33 feet). These devices use an industry standard size package and pinout. All devices are available as either common anode or common cathode.



These displays are ideal for most applications. Pin for pin equivalent displays are also available in a low current design. The low current displays are ideal for portable applications. For additional information see the Low Current Seven Segment Displays data sheet.

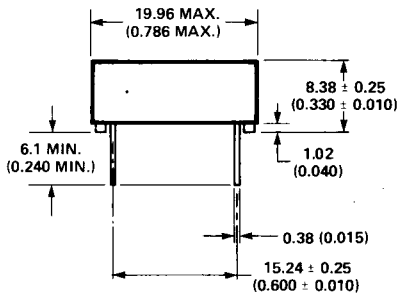
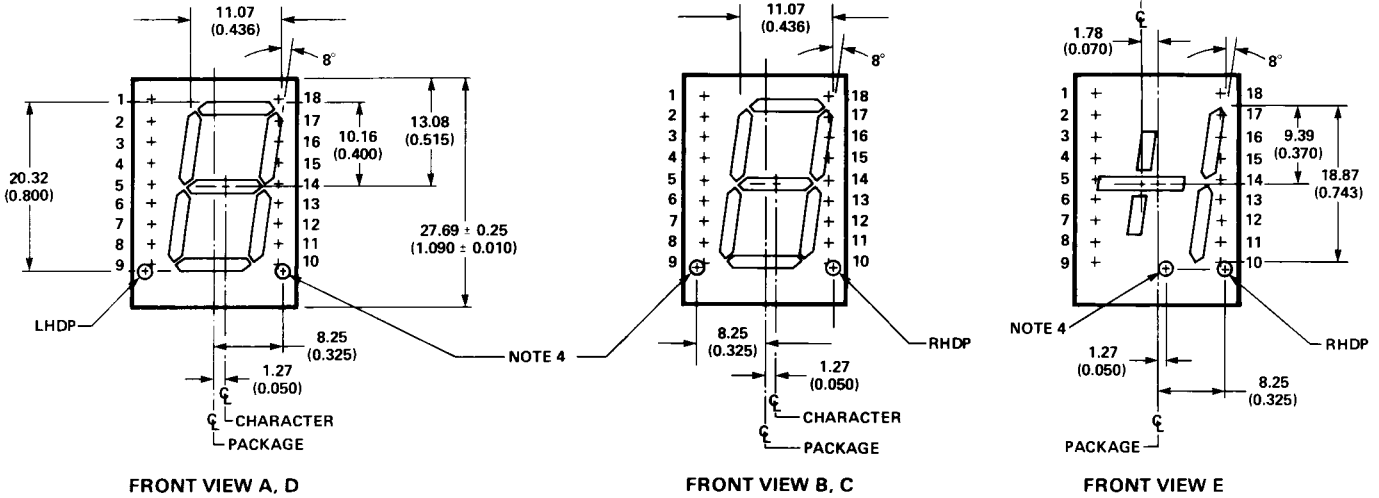
### Devices

Red HDSP-	AlGaAs <sup>[1]</sup> HDSP-	HER HDSP-	Yellow HDSP-	Green HDSP-	Description	Package Drawing
3400	N150	3900	4200	8600	Common Anode Left Hand Decimal	A
3401	N151	3901	4201	8601	Common Anode Right Hand Decimal	B
3403	N153	3903	4203	8603	Common Cathode Right Hand Decimal	C
3405	N155	3905	4205	8605	Common Cathode Left Hand Decimal	D
3406	N156	3906	4206	8606	Universal ± 1. Overflow <sup>[2]</sup>	E

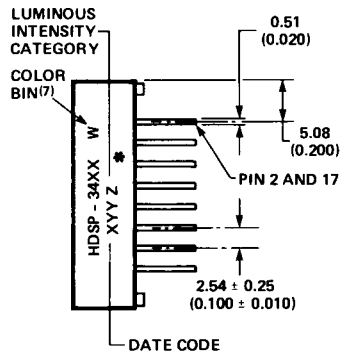
#### Notes:

1. These displays are recommended for high ambient light operation. Please refer to the HDSP-N10X AlGaAs data sheet for low current operation.
2. Universal pinout brings the anode and cathode of each segment's LED out to separate pins. See internal diagram E.

# Package Dimensions



END VIEW



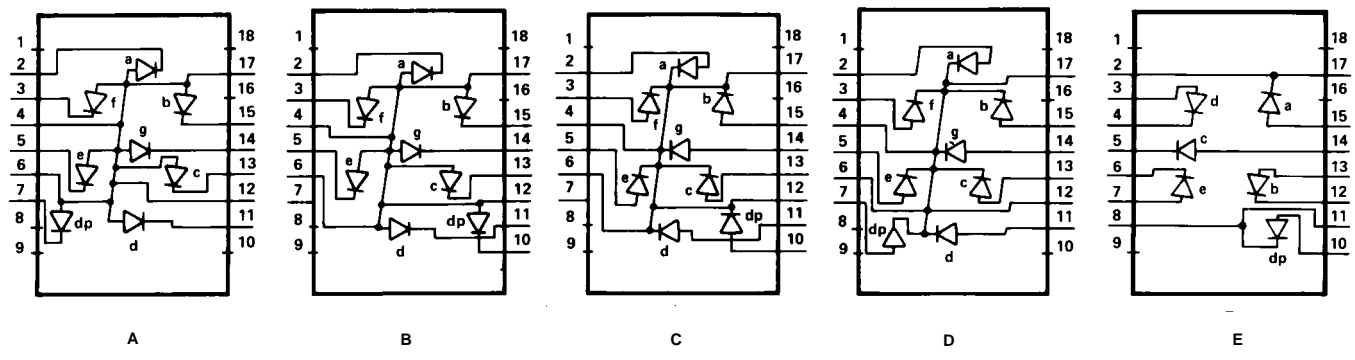
SIDE VIEW

\*The Side View of package indicates Country of Origin.

Pin	Function				
	A	B	C	D	E
1	NO PIN	NO PIN	NO PIN	NO PIN	NO PIN
2	CATHODE a	CATHODE a	ANODE a	ANODE a	CATHODE a
3	CATHODE f	CATHODE f	ANODE f	ANODE f	ANODE d
4	ANODE <sup>[3]</sup>	ANODE <sup>[3]</sup>	CATHODE <sup>[6]</sup>	CATHODE <sup>[6]</sup>	CATHODE d
5	CATHODE e	CATHODE e	ANODE e	ANODE e	CATHODE c
6	ANODE <sup>[3]</sup>	ANODE <sup>[3]</sup>	CATHODE <sup>[6]</sup>	CATHODE <sup>[6]</sup>	CATHODE e
7	CATHODE dp	NO. CONNec.	NO. CONNec.	ANODE dp	ANODE e
8	NO PIN	NO PIN	NO PIN	NO PIN	CATHODE dp
9	NO PIN	NO PIN	NO PIN	NO PIN	NO PIN
10	NO PIN	CATHODE dp	ANODE dp	NO PIN	ANODE dp
11	CATHODE d	CATHODE d	ANODE d	ANODE d	CATHODE dp
12	ANODE <sup>[3]</sup>	ANODE <sup>[3]</sup>	CATHODE <sup>[6]</sup>	CATHODE <sup>[6]</sup>	CATHODE b
13	CATHODE c	CATHODE c	ANODE c	ANODE c	ANODE b
14	CATHODE g	CATHODE g	ANODE g	ANODE g	ANODE c
15	CATHODE b	CATHODE b	ANODE b	ANODE b	ANODE a
16	NO PIN	NO PIN	NO PIN	NO PIN	NO PIN
17	ANODE <sup>[3]</sup>	ANODE <sup>[3]</sup>	CATHODE <sup>[6]</sup>	CATHODE <sup>[6]</sup>	CATHODE a
18	NO PIN	NO PIN	NO PIN	NO PIN	NO PIN

- NOTES:  
 1. DIMENSIONS IN MILLIMETERS AND (INCHES).  
 2. ALL UNTOLERANCED DIMENSIONS ARE FOR REFERENCE ONLY.  
 3. REDUNDANT ANODES.  
 4. UNUSED dp POSITION.  
 5. SEE INTERNAL CIRCUIT DIAGRAM.  
 6. REDUNDANT CATHODES.  
 7. FOR HDSP-4200/-8600 SERIES PRODUCT ONLY.

# Internal Circuit Diagram



## Absolute Maximum Ratings

Description	Red HDSP-3400 Series	AlGaAs Red HDSP-N150 Series	HER HDSP-3900 Series	Yellow HDSP-4200 Series	Green HDSP-8600 Series	Units
Average Power per Segment or DP	115	96	105	105	105	mW
Peak Forward Current per Segment or DP	200 <sup>[1]</sup>	160 <sup>[3]</sup>	135 <sup>[5]</sup>	135 <sup>[5]</sup>	90 <sup>[7]</sup>	mA
DC Forward Current per Segment or DP	50 <sup>[2]</sup>	40 <sup>[4]</sup>	40 <sup>[6]</sup>	40 <sup>[6]</sup>	30 <sup>[8]</sup>	mA
Operating Temperature Range	-40 to +100	-20 to +100 <sup>[9]</sup>	-40 to +100		-40 to +100	°C
Storage Temperature Range	-55 to +100					°C
Reverse Voltage per Segment or DP	3.0					V
Lead Solder Temperature for 3 Seconds (1.60 mm [0.063 in.] below seating plane)	260					°C

### Notes:

- See Figure 1 to establish pulsed conditions.
- Derate above 45°C at 0.83 mA/°C.
- See Figure 2 to establish pulsed conditions.
- Derate above 55°C at 0.8 mA/°C.
- See Figure 7 to establish pulsed conditions.
- Derate above 50°C at 0.73 mA/°C.
- See Figure 8 to establish pulsed conditions.
- Derate above 50°C at 0.54 mA/°C.
- For operation below -20°C, contact your local HP components sales office or an authorized distributor.

## Electrical/Optical Characteristics at T<sub>A</sub> = 25°C

### Red

Device Series	Parameter	Symbol	Min.	Typ.	Max.	Units	Test Conditions
HDSP-340X	Luminous Intensity/Segment <sup>[1,2]</sup> (Digit Average)	I <sub>V</sub>	500	1200		μcd	I <sub>F</sub> = 20 mA
	Forward Voltage/Segment or DP	V <sub>F</sub>		1.6	2.0	V	I <sub>F</sub> = 20 mA
	Peak Wavelength	λ <sub>PEAK</sub>		655		nm	
	Dominant Wavelength <sup>[3]</sup>	λ <sub>d</sub>		640		nm	
	Reverse Voltage/Segment or DP <sup>[4]</sup>	V <sub>R</sub>	3.0	20		V	I <sub>R</sub> = 100 μA
	Temperature Coefficient of V <sub>F</sub> /Segment or DP	ΔV <sub>F</sub> /°C		-2		mV/°C	
	Thermal Resistance LED Junction-to-Pin	Rθ <sub>J-PIN</sub>		375		°C/W	

### AlGaAs Red

Device Series	Parameter	Symbol	Min.	Typ.	Max.	Units	Test Conditions
HDSP-N15X	Luminous Intensity/Segment <sup>[1,2,5]</sup> (Digit Average)	$I_V$	6.0	14.0		mcd	$I_F = 20 \text{ mA}$
	Forward Voltage/Segment or DP	$V_F$		1.8		V	$I_F = 20 \text{ mA}$
				2.0	3.0	V	$I_F = 100 \text{ mA}$
	Peak Wavelength	$\lambda_{PEAK}$		645		nm	
	Dominant Wavelength <sup>[3]</sup>	$\lambda_d$		637		nm	
	Reverse Voltage/Segment or DP <sup>[4]</sup>	$V_R$	3.0	15		V	$I_R = 100 \mu\text{A}$
	Temperature Coefficient of $V_F$ /Segment or DP	$\Delta V_F/^\circ\text{C}$		-2		mV/ $^\circ\text{C}$	
Thermal Resistance LED Junction-to-Pin	$R\theta_{J-PIN}$		430		$^\circ\text{C}/\text{W}/\text{Seg}$		

### High Efficiency Red

Device Series	Parameter	Symbol	Min.	Typ.	Max.	Units	Test Conditions
HDSP-390X	Luminous Intensity/Segment <sup>[1,2]</sup> (Digit Average)	$I_V$	3350	7000		$\mu\text{cd}$	$I_F = 100 \text{ mA Peak: 1 of 5 df}$
				4800		$\mu\text{cd}$	$I_F = 20 \text{ mA}$
	Forward Voltage/Segment or DP	$V_F$		2.6	3.5	V	$I_F = 100 \text{ mA}$
	Peak Wavelength	$\lambda_{PEAK}$		635		nm	
	Dominant Wavelength <sup>[3]</sup>	$\lambda_d$		626		nm	
	Reverse Voltage/Segment or DP <sup>[4]</sup>	$V_R$	3.0	25		V	$I_R = 100 \mu\text{A}$
	Temperature Coefficient of $V_F$ /Segment or DP	$\Delta V_F/^\circ\text{C}$		-2		mV/ $^\circ\text{C}$	
Thermal Resistance LED Junction-to-Pin	$R\theta_{J-PIN}$		375		$^\circ\text{C}/\text{W}/\text{Seg}$		

## Yellow

Device Series	Parameter	Symbol	Min.	Typ.	Max.	Units	Test Conditions
HDSP-420X	Luminous Intensity/Segment <sup>[1,2]</sup> (Digit Average)	I <sub>V</sub>	2200	7000		μcd	I <sub>F</sub> = 100 mA Peak: 1 of 5 df
				3400		μcd	I <sub>F</sub> = 20 mA
	Forward Voltage/Segment or DP	V <sub>F</sub>		2.6	3.5	V	I <sub>F</sub> = 100 mA
	Peak Wavelength	λ <sub>PEAK</sub>		583		nm	
	Dominant Wavelength <sup>[3,6]</sup>	λ <sub>d</sub>	581.5	586	592.5	nm	
	Reverse Voltage/Segment or DP <sup>[4]</sup>	V <sub>R</sub>	3.0	25.0		V	I <sub>R</sub> = 100 μA
	Temperature Coefficient of V <sub>F</sub> /Segment or DP	ΔV <sub>F</sub> /°C		-2		mV/°C	
Thermal Resistance LED Junction-to-Pin	Rθ <sub>J-PIN</sub>		375		°C/W/ Seg		

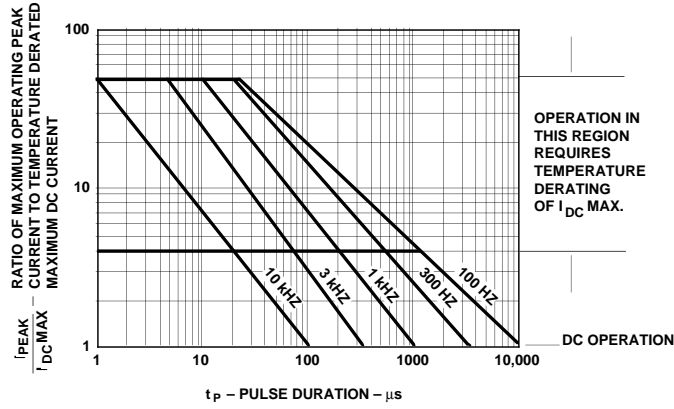
## Green

Device Series	Parameter	Symbol	Min.	Typ.	Max.	Units	Test Conditions
HDSP-860X	Luminous Intensity/Segment <sup>[1,2]</sup> (Digit Average)	I <sub>V</sub>	680	1500		μcd	I <sub>F</sub> = 10 mA
				1960		μcd	I <sub>F</sub> = 50 mA Peak: 1 of 5 df
	Forward Voltage/Segment or DP	V <sub>F</sub>		2.1	2.5	V	I <sub>F</sub> = 10 mA
	Peak Wavelength	λ <sub>PEAK</sub>		566		nm	
	Dominant Wavelength <sup>[3,6]</sup>	λ <sub>d</sub>		571	577	nm	
	Reverse Voltage/Segment or DP <sup>[4]</sup>	V <sub>R</sub>	3.0	50.0		V	I <sub>R</sub> = 100 μA
	Temperature Coefficient of V <sub>F</sub> /Segment or DP	ΔV <sub>F</sub> /°C		-2		mV/°C	
Thermal Resistance LED Junction-to-Pin	Rθ <sub>J-PIN</sub>		375		°C/W/ Seg		

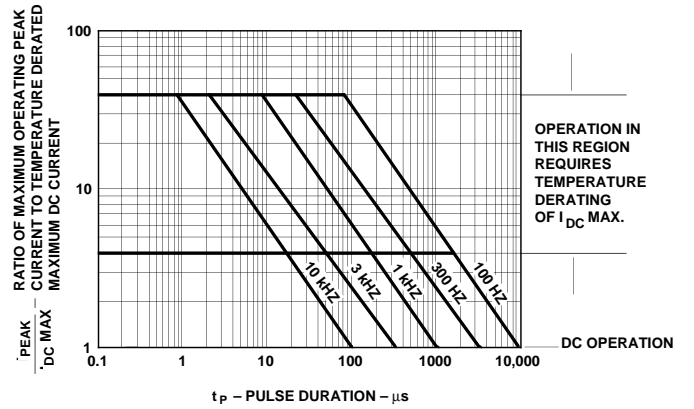
### Notes:

- Case temperature of the device immediately prior to the intensity measurement is 25°C.
- The digits are categorized for luminous intensity. The intensity category is designated by a letter on the side of the package.
- The dominant wavelength, λ<sub>d</sub>, is derived from the CIE chromaticity diagram and is that single wavelength which defines the color of the device.
- Typical specification for reference only. Do not exceed absolute maximum ratings.
- For low current operation, the AlGaAs Red HDSP-N100 series displays are recommended. They are tested at 1 mA dc/segment and are pin for pin compatible with the HDSP-N150 series.
- The Yellow (HDSP-4200) and Green (HDSP-8600) displays are categorized for dominant wavelength. The category is designated by a number adjacent to the luminous intensity category letter.

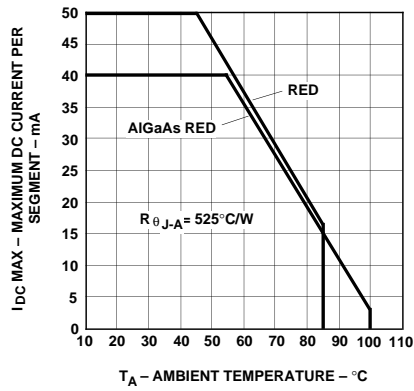
**Red, AlGaAs Red**



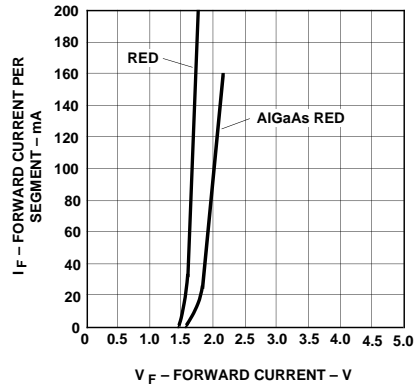
**Figure 1. Maximum Allowable Peak Current vs. Pulse Duration - Red.**



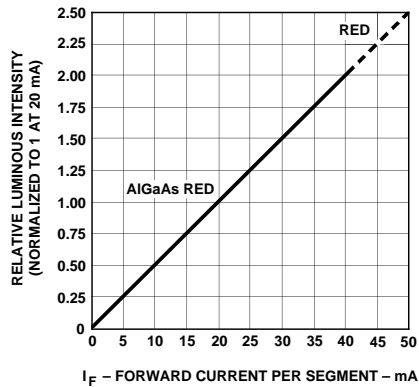
**Figure 2. Maximum Allowed Peak Current vs. Pulse Duration - AlGaAs Red.**



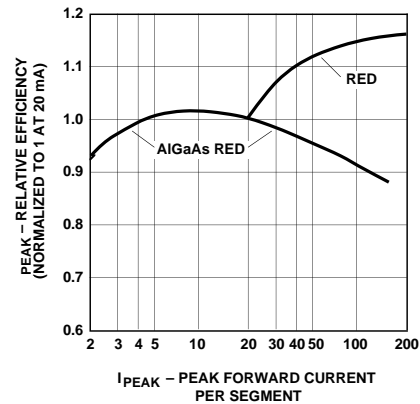
**Figure 3. Maximum Allowable DC Current vs. Ambient Temperature.**



**Figure 4. Forward Current vs. Forward Voltage.**

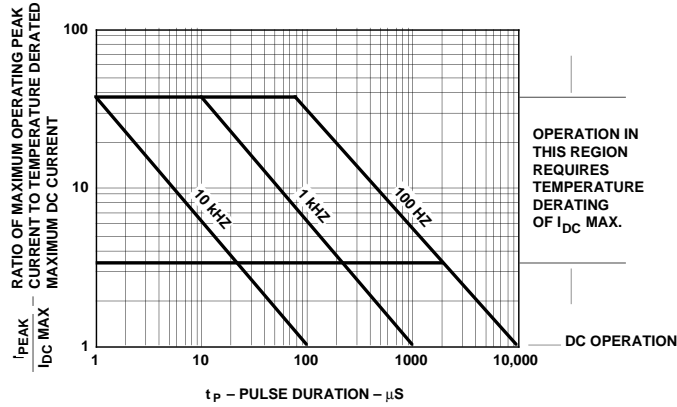


**Figure 5. Relative Luminous Intensity vs. DC Forward Current.**

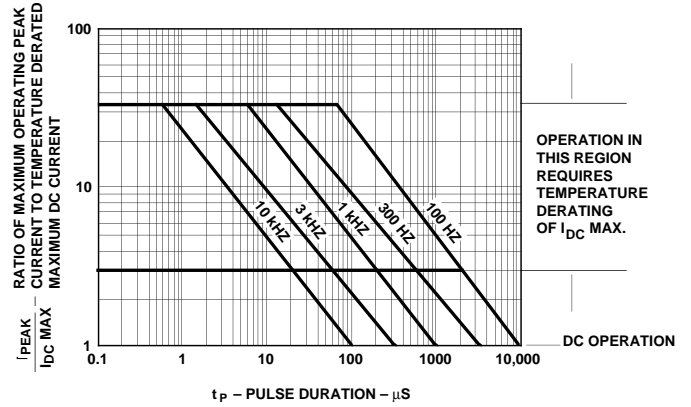


**Figure 6. Relative Efficiency (Luminous Intensity per Unit Current) vs. Peak Current.**

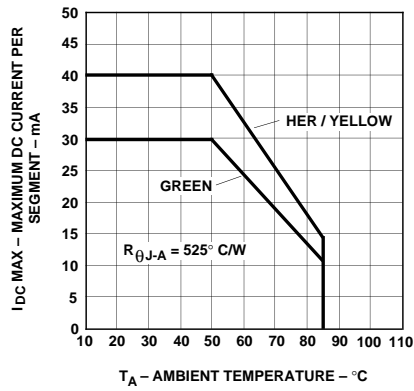
**HER, Yellow, Green**



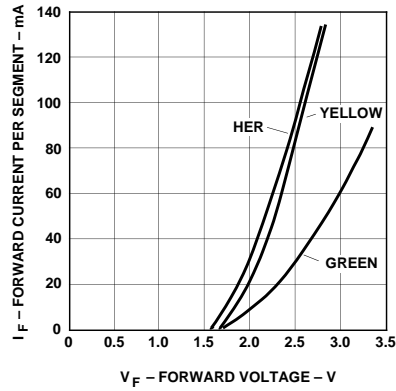
**Figure 7. Maximum Allowed Peak Current vs. Pulse Duration - HER, Yellow.**



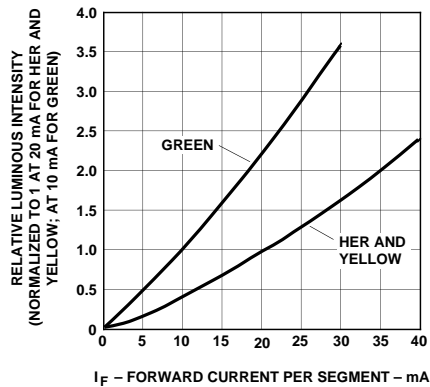
**Figure 8. Maximum Allowed Peak Current vs. Pulse Duration - Green.**



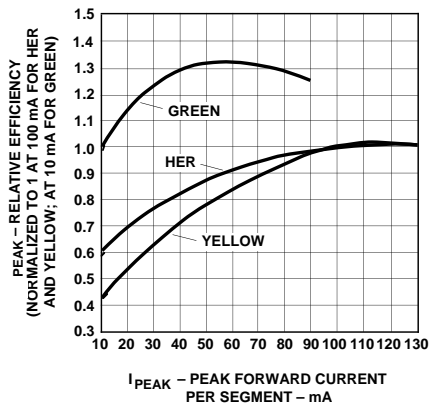
**Figure 9. Maximum Allowable DC Current vs. Ambient Temperature.**



**Figure 10. Forward Current vs. Forward Voltage.**



**Figure 11. Relative Luminous Intensity vs. DC Forward Current.**



**Figure 12. Relative Efficiency (Luminous Intensity per Unit Current) vs. Peak Current.**

## **Contrast Enhancement**

For information on contrast enhancement please see Application Note 1015.

## **Soldering/Cleaning**

Cleaning agents from the ketone family (acetone, methyl ethyl ketone, etc.) and from the chlorinated hydrocarbon family (methylene chloride, trichloroethylene, carbon tetrachloride, etc.) are not recommended for cleaning LED parts. All of these various solvents attack or dissolve the encapsulating epoxies used to form the package of plastic LED parts.

For information on soldering LEDs please refer to Application Note 1027.