



Integrated Device Technology, Inc.

CMOS STATIC RAM 1 MEG (256K x 4-BIT)

IDT71028

FEATURES:

- 256K x 4 advanced high-speed CMOS static RAM
- Equal access and cycle times
 - Commercial: 12/15/17/20ns
- One Chip Select plus one Output Enable pin
- Bidirectional data Inputs and outputs directly TTL-compatible
- Low power consumption via chip deselect
- Available in 400 mil Plastic SOJ package

DESCRIPTION:

The IDT71028 is a 1,048,576-bit high-speed static RAM organized as 256K x 4. It is fabricated using IDT's high-performance, high-reliability CMOS technology. This state-of-the-art technology, combined with innovative circuit design techniques, provides a cost-effective solution for high-speed memory needs.

The IDT71028 has an output enable pin which operates as fast as 6ns, with address access times as fast as 12ns. All bidirectional inputs and outputs of the IDT71028 are TTL-compatible and operation is from a single 5V supply. Fully static asynchronous circuitry is used, requiring no clocks or refresh for operation.

The IDT71028 is packaged in 28-pin 400 mil Plastic SOJ package.

FUNCTIONAL BLOCK DIAGRAM

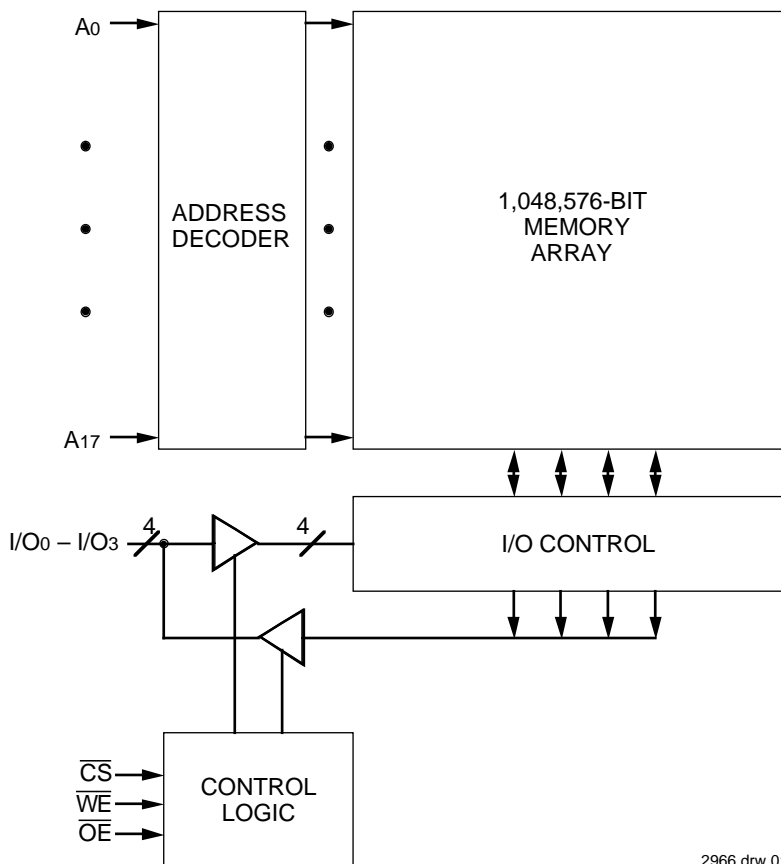

2966 drw 01

The IDT logo is a registered trademark of Integrated Device Technology, Inc.

COMMERCIAL TEMPERATURE RANGE

AUGUST 1996

PIN CONFIGURATION

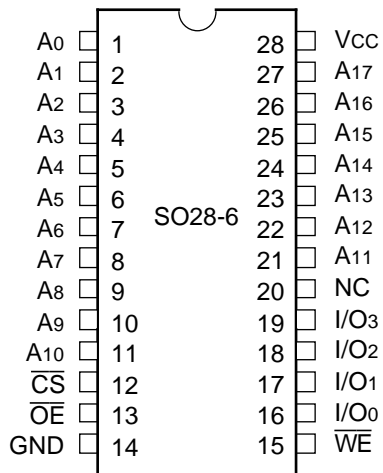

2966 drw 02

SOJ
TOP VIEW

ABSOLUTE MAXIMUM RATINGS⁽¹⁾

Symbol	Rating	Com'l.	Unit
V _{TERM} ⁽²⁾	Terminal Voltage with Respect to GND	-0.5 to +7.0	V
T _A	Operating Temperature	0 to +70	°C
T _{BIAS}	Temperature Under Bias	-55 to +125	°C
T _{STG}	Storage Temperature	-55 to +125	°C
P _T	Power Dissipation	1.25	W
I _{OUT}	DC Output Current	50	mA

NOTES:

2966 tbl 02

- Stresses greater than those listed under ABSOLUTE MAXIMUM RATINGS may cause permanent damage to the device. This is a stress rating only and functional operation of the device at these or any other conditions above those indicated in the operational sections of this specification is not implied. Exposure to absolute maximum rating conditions for extended periods may affect reliability.
- V_{TERM} must not exceed V_{CC} + 0.5V.

TRUTH TABLE^(1,2)

\overline{CS}	\overline{OE}	\overline{WE}	I/O	Function
L	L	H	DATA _{OUT}	Read Data
L	X	L	DATA _{IN}	Write Data
L	H	H	High-Z	Output Disabled
H	X	X	High-Z	Deselected - Standby (I _{SB})
V _{HC} ⁽³⁾	X	X	High-Z	Deselected - Standby (I _{SB1})

NOTES:

2966 tbl 01

- H = V_{IH}, L = V_{IL}, x = Don't care.
- V_{LC} = 0.2V, V_{HC} = V_{CC} - 0.2V.
- Other inputs ≥ V_{HC} or ≤ V_{LC}.

CAPACITANCE

(T_A = +25°C, f = 1.0MHz, SOJ package)

Symbol	Parameter ⁽¹⁾	Conditions	Max.	Unit
C _{IN}	Input Capacitance	V _{IN} = 3dV	8	pF
C _{I/O}	I/O Capacitance	V _{OUT} = 3dV	8	pF

NOTE:

2966 tbl 03

- This parameter is guaranteed by device characterization, but not production tested.

RECOMMENDED DC OPERATING CONDITIONS

Symbol	Parameter	Min.	Typ.	Max.	Unit
V _{CC}	Supply Voltage	4.5	5.0	5.5	V
GND	Supply Voltage	0	0	0	V
V _{IH}	Input High Voltage	2.2	—	V _{CC} +0.5	V
V _{IL}	Input Low Voltage	-0.5 ⁽¹⁾	—	0.8	V

NOTE:

2966 tbl 04

- V_{IL} (min.) = -1.5V for pulse width less than 10ns, once per cycle.

DC ELECTRICAL CHARACTERISTICS

V_{CC} = 5.0V ± 10%

Symbol	Parameter	Test Condition	IDT71028		Unit
			Min.	Max.	
I _{LI}	Input Leakage Current	V _{CC} = Max., V _{IN} = GND to V _{CC}	—	5	μA
I _{LO}	Output Leakage Current	V _{CC} = Max., \overline{CS} = V _{IH} , V _{OUT} = GND to V _{CC}	—	5	μA
V _{OL}	Output Low Voltage	I _{OL} = 8mA, V _{CC} = Min.	—	0.4	V
V _{OH}	Output High Voltage	I _{OH} = -4mA, V _{CC} = Min.	2.4	—	V

2966 tbl 05

DC ELECTRICAL CHARACTERISTICS⁽¹⁾

($V_{CC} = 5.0V \pm 10\%$, $V_{LC} = 0.2V$, $V_{HC} = V_{CC} - 0.2V$)

Symbol	Parameter	71028S12 ⁽³⁾		71028S15		71028S17		71028S20		Unit
		Com'l.	Mil.	Com'l.	Mil.	Com'l.	Mil.	Com'l.	Mil.	
I _{CC}	Dynamic Operating Current, $\overline{CS} \leq V_{IL}$, Outputs Open, $V_{CC} = \text{Max.}$, $f = f_{MAX}$ ⁽²⁾	155	—	150	—	145	—	145	—	mA
I _{SB}	Standby Power Supply Current (TTL Level), $\overline{CS} \geq V_{IH}$, Outputs Open, $V_{CC} = \text{Max.}$, $f = f_{MAX}$ ⁽²⁾	35	—	35	—	35	—	35	—	mA
I _{SB1}	Full Standby Power Supply Current (CMOS Level), $\overline{CS} \geq V_{HC}$, Outputs Open, $V_{CC} = \text{Max.}$, $f = 0$ ⁽²⁾ , $V_{IN} \leq V_{LC}$ or $V_{IN} \geq V_{HC}$	10	—	10	—	10	—	10	—	mA

NOTES:

- All values are maximum guaranteed values.
- $f_{MAX} = 1/t_{RC}$ (all address inputs are cycling at f_{MAX}); $f = 0$ means no address input lines are changing.
- 12ns specification is preliminary.

2966 tbl 06

AC TEST CONDITIONS

Input Pulse Levels	GND to 3.0V
Input Rise/Fall Times	3ns
Input Timing Reference Levels	1.5V
Output Reference Levels	1.5V
AC Test Load	See Figures 1 and 2

2966 tbl 07

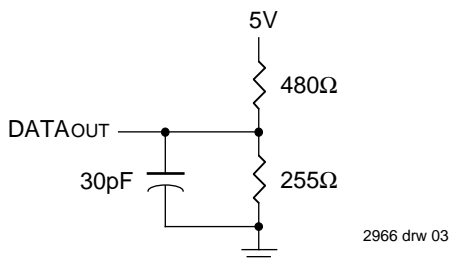
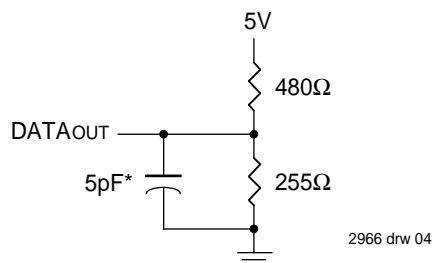

Figure 1. AC Test Load



*Including jig and scope capacitance.

Figure 2. AC Test Load
(for t_{CLZ}, t_{OLZ}, t_{CHZ}, t_{OHZ}, t_{ow}, and t_{whz})

AC ELECTRICAL CHARACTERISTICS ($V_{CC} = 5.0V \pm 10\%$, Commercial Temperature Range)

Symbol	Parameter	71028S12 ⁽¹⁾		71028S15		71028S17		71028S20		Unit
		Min.	Max.	Min.	Max.	Min.	Max.	Min.	Max.	
Read Cycle										
t _{RC}	Read Cycle Time	12	—	15	—	17	—	20	—	ns
t _{AA}	Address Access Time	—	12	—	15	—	17	—	20	ns
t _{ACS}	Chip Select Access Time	—	12	—	15	—	17	—	20	ns
t _{CLZ} ⁽²⁾	Chip Select to Output in Low-Z	3	—	3	—	3	—	3	—	ns
t _{CHZ} ⁽²⁾	Chip Deselect to Output in High-Z	0	6	0	7	0	8	0	8	ns
t _{OE}	Output Enable to Output Valid	—	6	—	7	—	8	—	8	ns
t _{OLZ} ⁽²⁾	Output Enable to Output in Low-Z	0	—	0	—	0	—	0	—	ns
t _{OHZ} ⁽²⁾	Output Disable to Output in High-Z	0	5	0	5	0	6	0	7	ns
t _{OH}	Output Hold from Address Change	4	—	4	—	4	—	4	—	ns
t _{PU} ⁽²⁾	Chip Select to Power Up Time	0	—	0	—	0	—	0	—	ns
t _{PD} ⁽²⁾	Chip Deselect to Power Down Time	—	12	—	15	—	17	—	20	ns
Write Cycle										
t _{WC}	Write Cycle Time	12	—	15	—	17	—	20	—	ns
t _{AW}	Address Valid to End of Write	10	—	12	—	13	—	15	—	ns
t _{CW}	Chip Select to End of Write	10	—	12	—	13	—	15	—	ns
t _{AS}	Address Set-up Time	0	—	0	—	0	—	0	—	ns
t _{WP}	Write Pulse Width	10	—	12	—	13	—	15	—	ns
t _{WR}	Write Recovery Time	0	—	0	—	0	—	0	—	ns
t _{DW}	Data Valid to End of Write	7	—	8	—	9	—	9	—	ns
t _{DH}	Data Hold Time	0	—	0	—	0	—	0	—	ns
t _{OW} ⁽²⁾	Output Active from End of Write	3	—	3	—	3	—	4	—	ns
t _{WHZ} ⁽²⁾	Write Enable to Output in High-Z	0	5	0	5	0	7	0	8	ns

NOTES:

- 12ns specification is preliminary.
- This parameter guaranteed with the AC load (Figure 2) by device characterization, but is not production tested.

2966 tbl 08

TIMING WAVEFORM OF READ CYCLE NO. 1⁽¹⁾

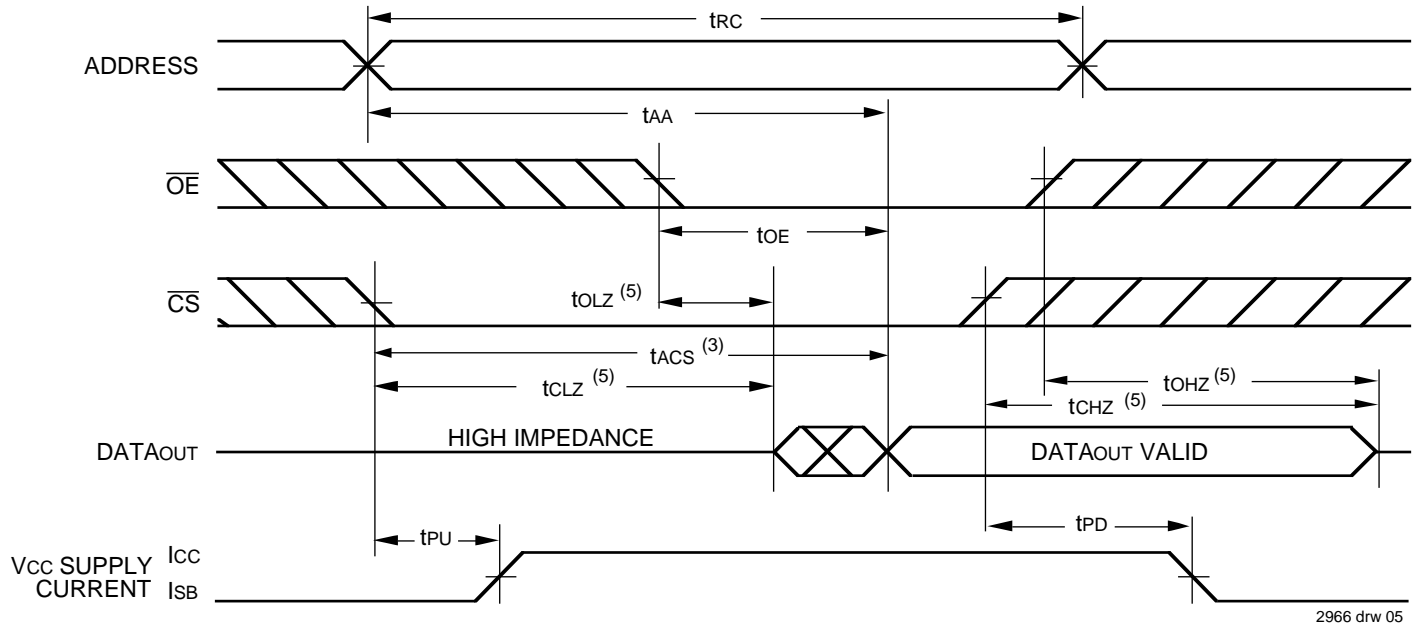

TIMING WAVEFORM OF READ CYCLE NO. 2^(1,2,4)

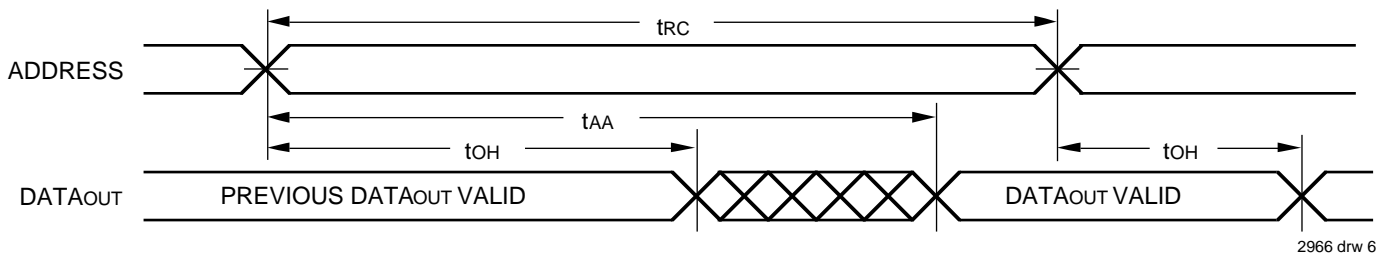

NOTES:

1. \overline{WE} is HIGH for Read Cycle.
2. Device is continuously selected, \overline{CS} is LOW.
3. Address must be valid prior to or coincident with the later of \overline{CS} transition LOW; otherwise t_{AA} is the limiting parameter.
4. \overline{OE} is LOW.
5. Transition is measured $\pm 200\text{mV}$ from steady state.

TIMING WAVEFORM OF WRITE CYCLE NO.1 (\overline{WE} CONTROLLED TIMING)^(1,2,3,5)

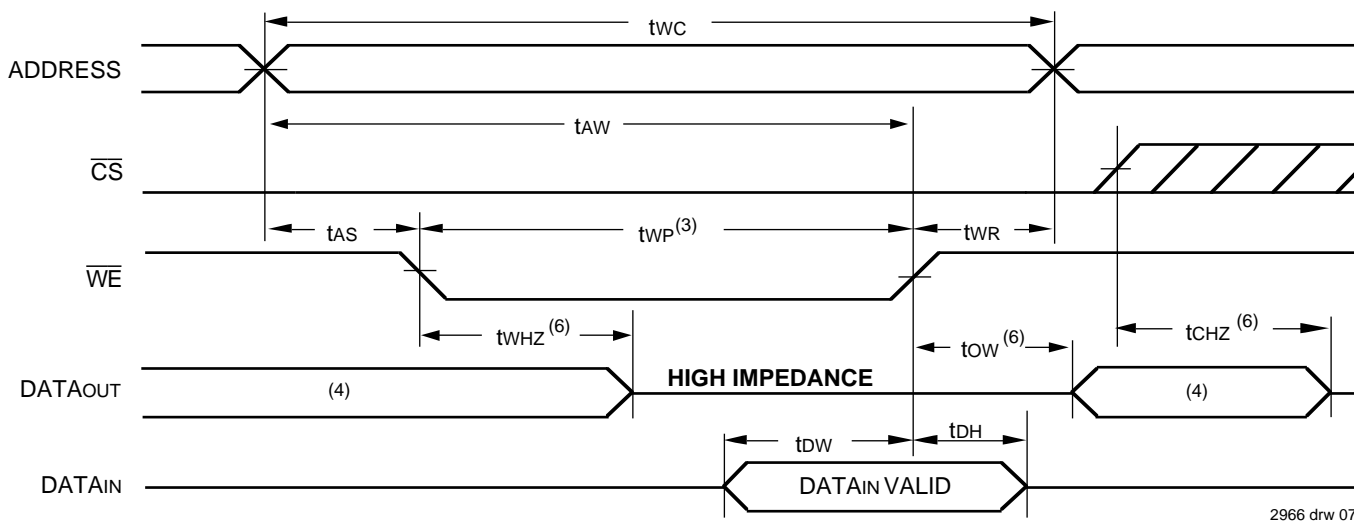

2966 drw 07

TIMING WAVEFORM OF WRITE CYCLE NO.2 (\overline{CS} CONTROLLED TIMING)^(1,2,5)

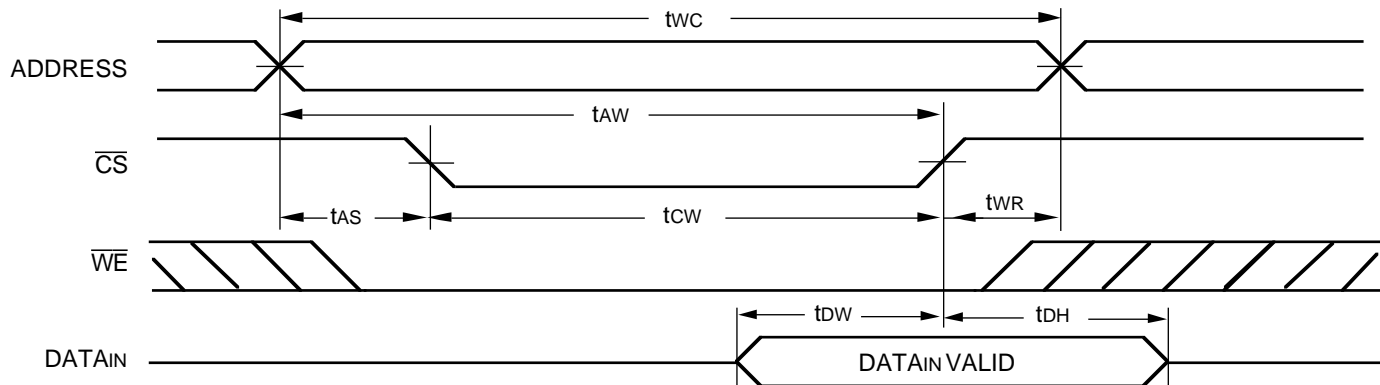

2966 drw 08

NOTES:

1. \overline{WE} or \overline{CS} must be HIGH during all address transitions.
2. A write occurs during the overlap of a LOW \overline{CS} and a LOW \overline{WE} .
3. \overline{OE} is continuously HIGH. If during a \overline{WE} controlled write cycle \overline{OE} is LOW, t_{WP} must be greater than or equal to $t_{WHZ} + t_{OW}$ to allow the I/O drivers to turn off and data to be placed on the bus for the required t_{DW} . If \overline{OE} is HIGH during a \overline{WE} controlled write cycle, this requirement does not apply and the minimum write pulse is as short as the specified t_{WP} .
4. During this period, I/O pins are in the output state, and input signals must not be applied.
5. If the \overline{CS} LOW transition occurs simultaneously with or after the \overline{WE} LOW transition, the outputs remain in a high-impedance state.
6. Transition is measured $\pm 200mV$ from steady state.

ORDERING INFORMATION

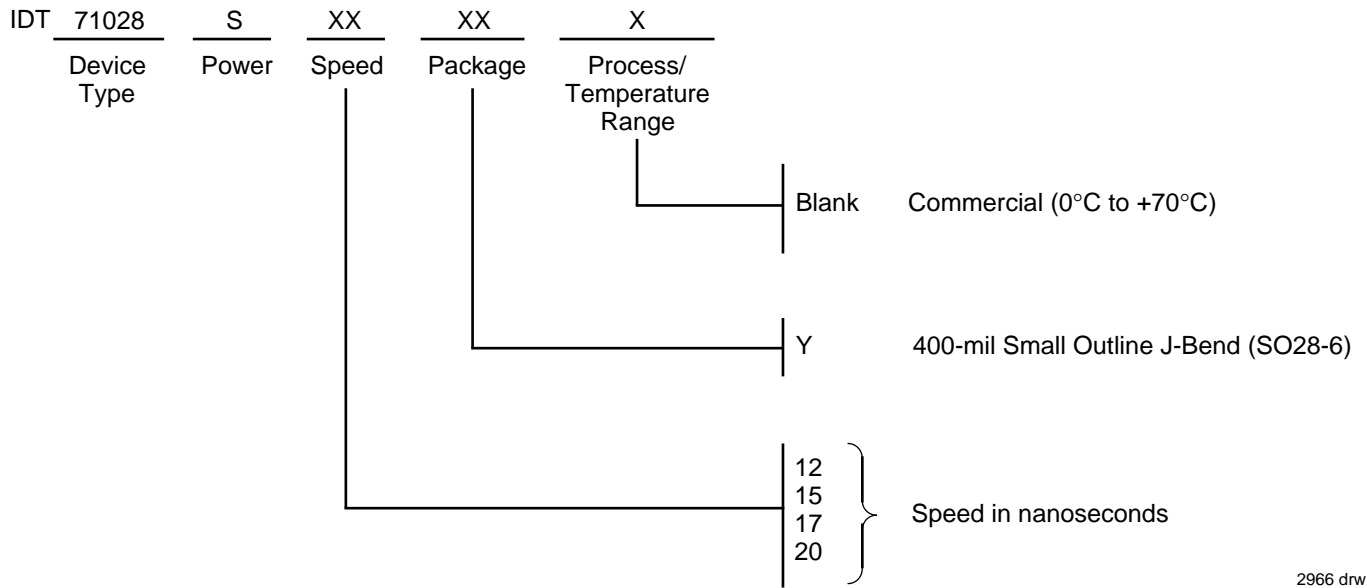

2966 drw 09