

IN74HCT125A

Quad 3-State Noninverting Buffers
High-Performance Silicon-Gate CMOS

The IN74HCT125A is identical in pinout to the LS/ALS125. The IN74HCT125A may be used as a level converter for interfacing TTL or NMOS outputs to High Speed CMOS inputs.

The IN74HCT125A noninverting buffers are designed to be used with 3-state memory address drivers, clock drivers, and other bus-oriented systems. The devices have four separate output enables that are active-low.

- TTL/NMOS Compatible Input Levels
- Outputs Directly Interface to CMOS, NMOS, and TTL
- Operating Voltage Range: 4.5 to 5.5 V
- Low Input Current: 1.0 μ A

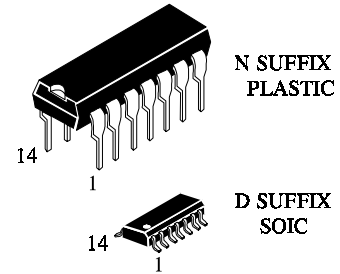

ORDERING INFORMATION

IN74HCT125AN Plastic

IN74HCT125AD SOIC

$T_A = -55^\circ$ to 125° C for all packages

LOGIC DIAGRAM

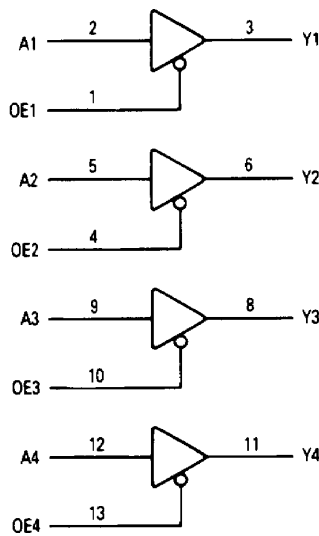

PIN 14 = V_{CC}
 PIN 7 = GND

PIN ASSIGNMENT

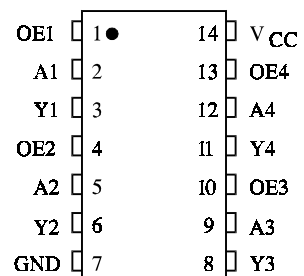

FUNCTION TABLE

Inputs		Output
A	OE	Y
H	L	H
L	L	L
X	H	Z

X = don't care

Z = high impedance

MAXIMUM RATINGS*

Symbol	Parameter	Value	Unit
V _{CC}	DC Supply Voltage (Referenced to GND)	-0.5 to +7.0	V
V _{IN}	DC Input Voltage (Referenced to GND)	-1.5 to V _{CC} +1.5	V
V _{OUT}	DC Output Voltage (Referenced to GND)	-0.5 to V _{CC} +0.5	V
I _{IN}	DC Input Current, per Pin	±20	mA
I _{OUT}	DC Output Current, per Pin	±35	mA
I _{CC}	DC Supply Current, V _{CC} and GND Pins	±75	mA
P _D	Power Dissipation in Still Air, Plastic DIP+ SOIC Package+	750 500	mW
T _{stg}	Storage Temperature	-65 to +150	°C
T _L	Lead Temperature, 1 mm from Case for 10 Seconds (Plastic DIP or SOIC Package)	260	°C

*Maximum Ratings are those values beyond which damage to the device may occur. Functional operation should be restricted to the Recommended Operating Conditions.

+Derating - Plastic DIP: - 10 mW/°C from 65° to 125°C
SOIC Package: - 7 mW/°C from 65° to 125°C

RECOMMENDED OPERATING CONDITIONS

Symbol	Parameter	Min	Max	Unit
V _{CC}	DC Supply Voltage (Referenced to GND)	4.5	5.5	V
V _{IN} , V _{OUT}	DC Input Voltage, Output Voltage (Referenced to GND)	0	V _{CC}	V
T _A	Operating Temperature, All Package Types	-55	+125	°C
t _r , t _f	Input Rise and Fall Time (Figure 1)	0	500	ns

This device contains protection circuitry to guard against damage due to high static voltages or electric fields. However, precautions must be taken to avoid applications of any voltage higher than maximum rated voltages to this high-impedance circuit. For proper operation, V_{IN} and V_{OUT} should be constrained to the range $GND \leq (V_{IN} \text{ or } V_{OUT}) \leq V_{CC}$.

Unused inputs must always be tied to an appropriate logic voltage level (e.g., either GND or V_{CC}). Unused outputs must be left open.

DC ELECTRICAL CHARACTERISTICS(Voltages Referenced to GND)

Symbol	Parameter	Test Conditions	V _{CC} V	Guaranteed Limit			Unit
				25 °C to -55°C	≤85 °C	≤125 °C	
V _{IH}	Minimum High-Level Input Voltage	V _{OUT} = V _{CC} -0.1 V I _{OUT} ≤ 20 μA	4.5	2.0	2.0	2.0	V
			5.5	2.0	2.0	2.0	
V _{IL}	Maximum Low - Level Input Voltage	V _{OUT} =0.1 V I _{OUT} ≤ 20 μA	4.5	0.8	0.8	0.8	V
			5.5	0.8	0.8	0.8	
V _{OH}	Minimum High-Level Output Voltage	V _{IN} =V _{IH} I _{OUT} ≤ 20 μA	4.5	4.4	4.4	4.4	V
		V _{IN} =V _{IH} I _{OUT} ≤ 6.0 mA	5.5	5.4	5.4	5.4	
V _{OL}	Maximum Low-Level Output Voltage	V _{IN} =V _{IL} I _{OUT} ≤ 20 μA	4.5	0.1	0.1	0.1	V
		V _{IN} =V _{IL} I _{OUT} ≤ 6.0 mA	5.5	0.1	0.1	0.1	
I _{IN}	Maximum Input Leakage Current	V _{IN} =V _{CC} or GND	4.5	±0.1	±1.0	±1.0	μA
			5.5	±0.1	±1.0	±1.0	
I _{OZ}	Maximum Three-State Leakage Current	Output in High-Impedance State V _{IN} =V _{IL} or V _{IH} V _{IN} =V _{CC} or GND	5.5	±0.5	±5.0	±10	μA
I _{CC}	Maximum Quiescent Supply Current (per Package)	V _{IN} =V _{CC} or GND I _{OUT} =0μA	5.5	4.0	40	160	μA
ΔI _{CC}	Additional Quiescent Supply Current	V _{IN} = 2.4 V, Any One Input V _{IN} =V _{CC} or GND, Other Inputs I _{OUT} =0μA	V _{CC} V	≥-55°C	25°C to 125°C		mA
				5.5	2.9	2.4	

AC ELECTRICAL CHARACTERISTICS($V_{CC}=5.0\text{ V} \pm 10\%$, $C_L=50\text{pF}$, Input $t_r=t_f=6.0\text{ ns}$)

Symbol	Parameter	Guaranteed Limit			Unit
		25 °C to -55°C	≤85°C	≤125°C	
t_{PLH} , t_{PHL}	Maximum Propagation Delay, Input A to Output Y (Figures 1 and 3)	18	23	27	ns
t_{PLZ} , t_{PHZ}	Maximum Propagation Delay, Output Enable to Y (Figures 2 and 4)	24	30	36	ns
t_{PZL} , t_{PZH}	Maximum Propagation Delay, Output Enable to Y (Figures 2 and 4)	18	23	27	ns
t_{TLH} , t_{THL}	Maximum Output Transition Time, Any Output (Figures 1 and 3)	12	15	18	ns
C_{IN}	Maximum Input Capacitance	10	10	10	pF
C_{OUT}	Maximum Three-State Output Capacitance (Output in High-Impedance State)	15	15	15	pF

C_{PD}	Power Dissipation Capacitance (Per Buffer)	Typical @25°C, $V_{CC}=5.0\text{ V}$		pF
	Used to determine the no-load dynamic power consumption: $P_D=C_{PD}V_{CC}^2f+I_{CC}V_{CC}$	48		

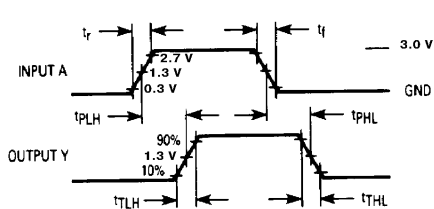

Figure 1. Switching Waveforms

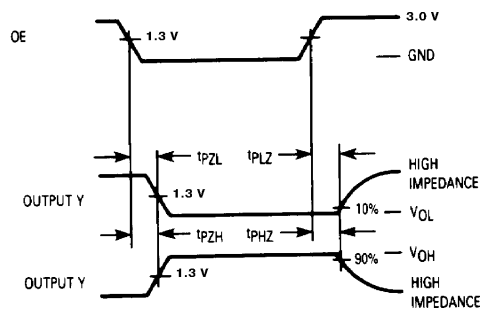
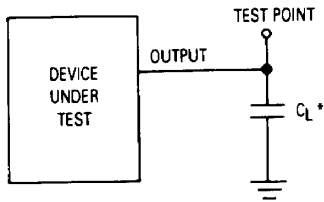
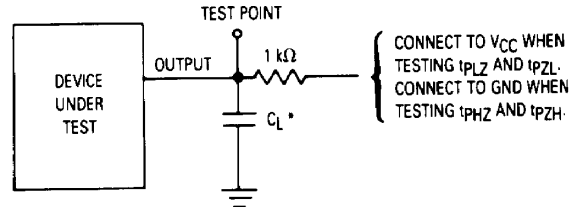

Figure 2. Switching Waveforms



*Includes all probe and jig capacitance.

Figure 3. Test Circuit



*Includes all probe and jig capacitance.

Figure 4. Test Circuit

EXPANDED LOGIC DIAGRAM
(1/4 of the Device)

