

1A, 100V, 1.200 Ohm, Logic Level, N-Channel Power MOSFET

September 1998

Features

- 1A, 100V
- $r_{DS(ON)} = 1.200\Omega$

Ordering Information

PART NUMBER	PACKAGE	BRAND
RFL1N10L	TO-205AF	RFL1N10L

NOTE: When ordering, use the entire part number.

Description

This is an N-Channel enhancement mode silicon gate power field effect transistor specifically designed for use with logic level (5V) driving sources in applications such as programmable controllers, automotive switching, and solenoid drivers. This performance is accomplished through a special gate oxide design which provides full rated conduction at gate biases in the 3V to 5V range, thereby facilitating true on-off power control directly from logic circuit supply voltages.

Formerly developmental type TA09524.

Symbol

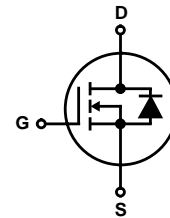

Packaging

JEDEC TO-205AF

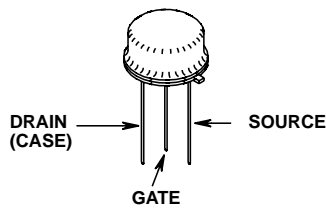

RFL1N10L

Absolute Maximum Ratings $T_C = 25^\circ\text{C}$, Unless Otherwise Specified

	RFL1N10L	UNITS
Drain to Source Voltage (Note 1)	100	V
Drain to Gate Voltage ($R_{GS} = 1M\Omega$) (Note 1)	100	V
Continuous Drain Current	1	A
Pulsed Drain Current (Note 3)	5	A
Gate to Source Voltage	± 10	V
Maximum Power Dissipation	8.33	W
Above $T_C = 25^\circ\text{C}$, Derate Linearly	0.0667	$W/^\circ\text{C}$
Operating and Storage Temperature	-55 to 150	$^\circ\text{C}$
Maximum Temperature for Soldering Leads at 0.063in (1.6mm) from Case for 10s	260	$^\circ\text{C}$

CAUTION: Stresses above those listed in "Absolute Maximum Ratings" may cause permanent damage to the device. This is a stress only rating and operation of the device at these or any other conditions above those indicated in the operational sections of this specification is not implied.

NOTE:

1. $T_J = 25^\circ\text{C}$ to 125°C .

Electrical Specifications $T_C = 25^\circ\text{C}$, Unless Otherwise Specified

PARAMETER	SYMBOL	TEST CONDITIONS	MIN	TYP	MAX	UNITS
Drain to Source Breakdown Voltage	BV_{DSS}	$I_D = 250\mu\text{A}$, $V_{GS} = 0$	100	-	-	V
Gate Threshold Voltage	$V_{GS(TH)}$	$V_{GS} = V_{DS}$, $I_D = 250\mu\text{A}$	1	-	2	V
Zero Gate Voltage Drain Current	I_{DSS}	$V_{DS} = \text{Rated } BV_{DSS}$	-	-	1	μA
		$V_{DS} = 0.8 \times \text{Rated } BV_{DSS}$, $V_{GS} = 80\text{V}$, $T_C = 125^\circ\text{C}$	-	-	25	μA
Gate to Source Leakage Current	I_{GSS}	$V_{GS} = \pm 10\text{V}$, $V_{DS} = 0$	-	-	± 100	nA
Drain to Source On Resistance (Note 2)	$r_{DS(ON)}$	$I_D = 1\text{A}$, $V_{GS} = 5\text{V}$ (Figures 6, 7)	-	-	1.200	Ω
Drain to Source On Voltage (Note 2)	$V_{DS(ON)}$	$I_D = 1\text{A}$, $V_{GS} = 5\text{V}$	-	-	1.2	V
Turn-On Delay Time	$t_{d(ON)}$	$I_D = 1\text{A}$, $V_{DD} = 50\text{V}$, $R_G = 6.25\Omega$, $V_{GS} = 5\text{V}$, $R_L = 50\Omega$ (Figures 10, 11, 12)	-	10	25	ns
Rise Time	t_r		-	15	45	ns
Turn-Off Delay Time	$t_{d(OFF)}$		-	25	45	ns
Fall Time	t_f		-	30	50	ns
Input Capacitance	C_{ISS}	$V_{GS} = 0\text{V}$, $V_{DS} = 25\text{V}$, $f = 1\text{MHz}$ (Figure 9)	-	-	200	pF
Output Capacitance	C_{OSS}		-	-	80	pF
Reverse Transfer Capacitance	C_{RSS}		-	-	35	pF
Thermal Resistance Junction to Case	$R_{\theta JC}$		-	-	15	$^\circ\text{C/W}$

Source to Drain Diode Specifications

PARAMETER	SYMBOL	TEST CONDITIONS	MIN	TYP	MAX	UNITS
Source to Drain Diode Voltage (Note 2)	V_{SD}	$I_{SD} = 1\text{A}$	-	-	1.4	V
Diode Reverse Recovery Time	t_{rr}	$I_{SD} = 2\text{A}$, $dI_{SD}/dt = 50\text{A}/\mu\text{s}$	-	100	-	ns

NOTES:

2. Pulse test: width $\leq 300\mu\text{s}$ duty cycle $\leq 2\%$.
3. Repetitive rating: pulse width limited by maximum junction temperature.

RFL1N10L

Typical Performance Curves Unless Otherwise Specified

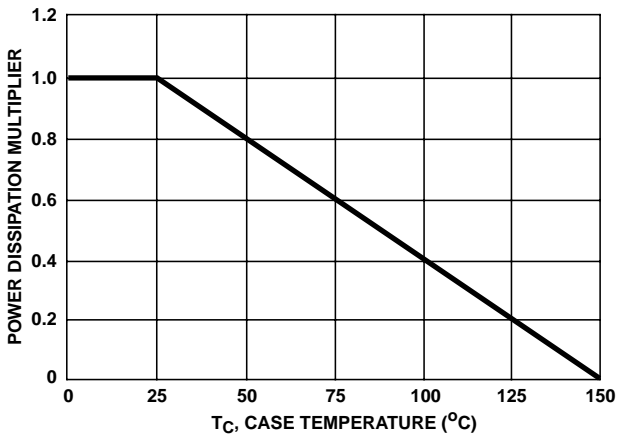

FIGURE 1. NORMALIZED POWER DISSIPATION vs CASE TEMPERATURE

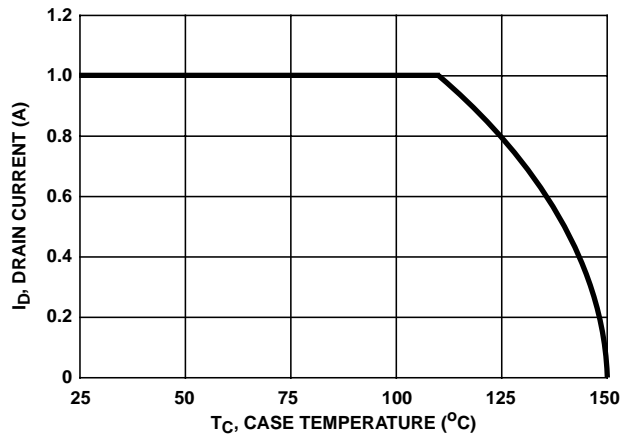

FIGURE 2. MAXIMUM CONTINUOUS DRAIN CURRENT vs CASE TEMPERATURE

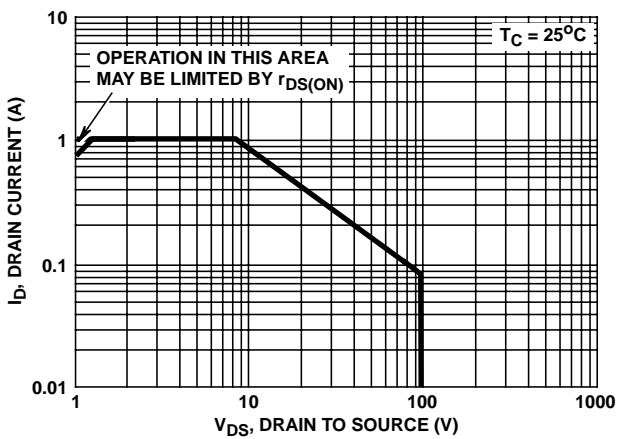

FIGURE 3. FORWARD BIAS SAFE OPERATING AREA

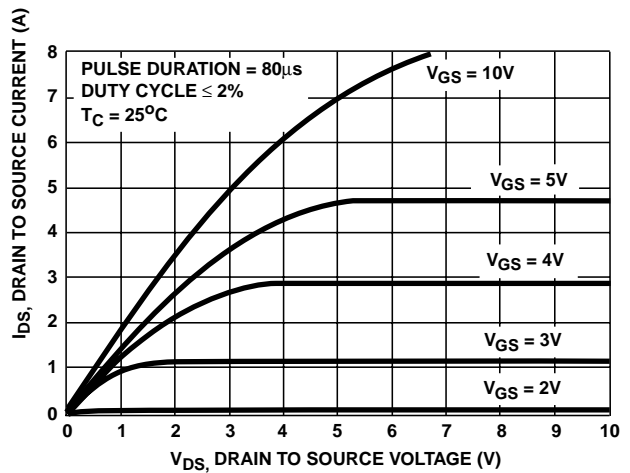

FIGURE 4. SATURATION CHARACTERISTICS

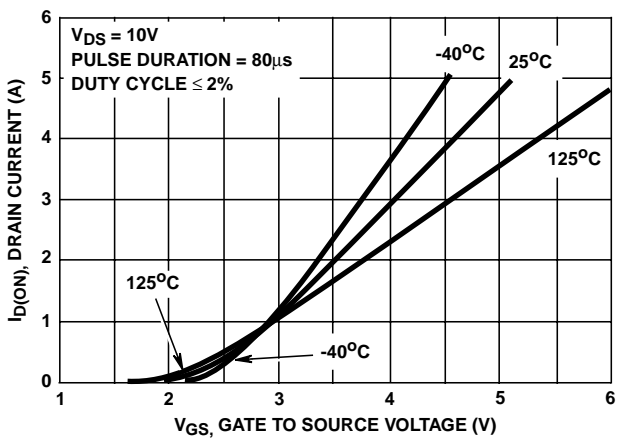

FIGURE 5. TRANSFER CHARACTERISTICS

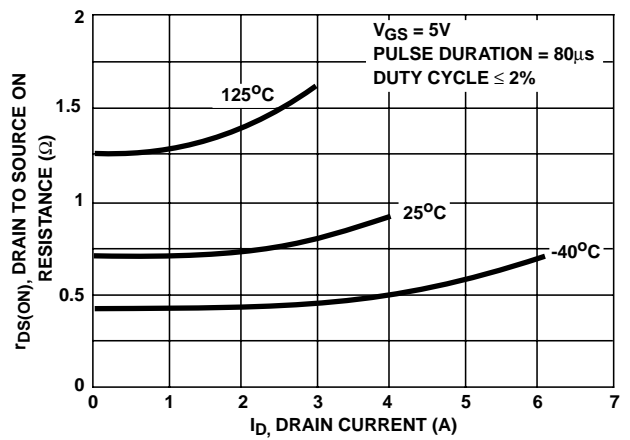

FIGURE 6. DRAIN TO SOURCE ON RESISTANCE vs DRAIN CURRENT

RFL1N10L

Typical Performance Curves Unless Otherwise Specified (Continued)

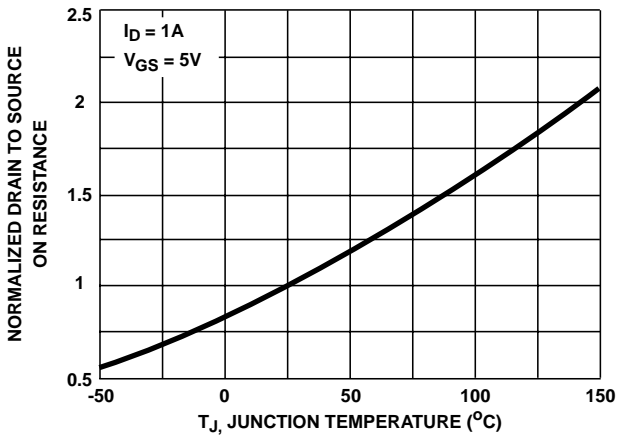

FIGURE 7. NORMALIZED DRAIN TO SOURCE ON RESISTANCE vs JUNCTION TEMPERATURE

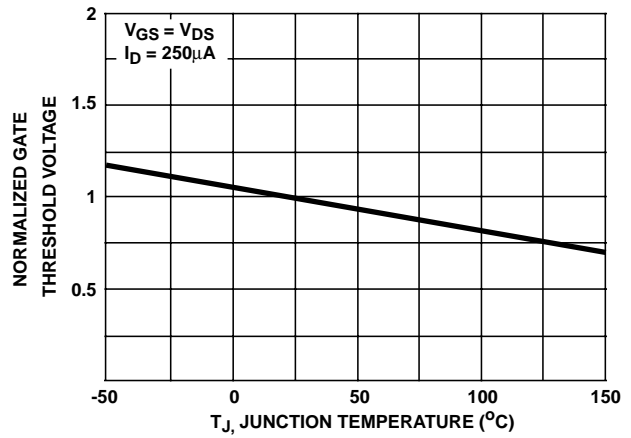

FIGURE 8. NORMALIZED GATE THRESHOLD VOLTAGE vs JUNCTION TEMPERATURE

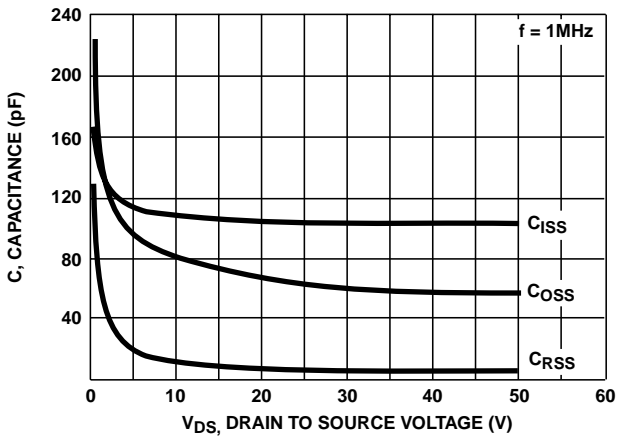
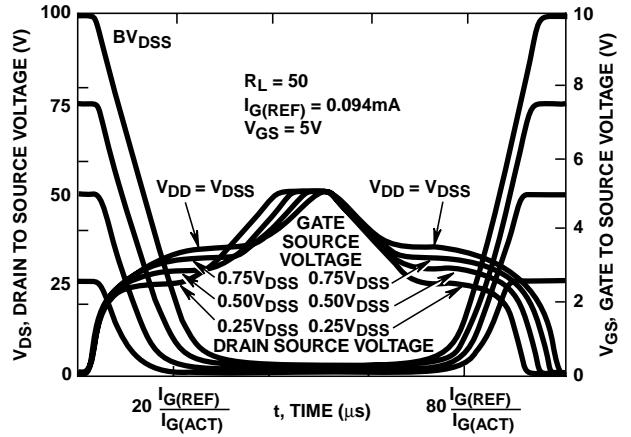

FIGURE 9. CAPACITANCE vs DRAIN TO SOURCE VOLTAGE



NOTE: Refer to Intersil Application Notes AN7254 and AN7260.

FIGURE 10. NORMALIZED SWITCHING WAVEFORMS FOR CONSTANT GATE CURRENT

Test Circuits and Waveforms

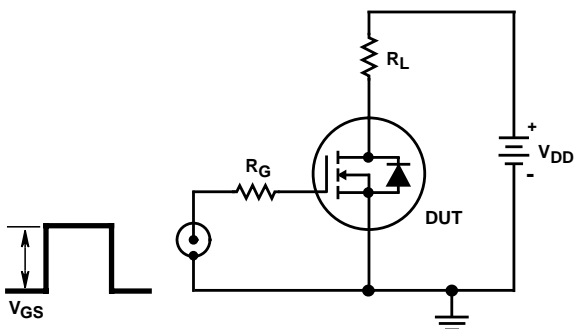

FIGURE 11. SWITCHING TIME TEST CIRCUIT

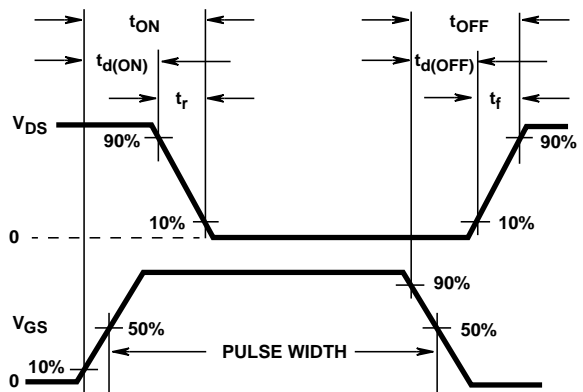

FIGURE 12. RESISTIVE SWITCHING WAVEFORMS

RFL1N10L

All Intersil semiconductor products are manufactured, assembled and tested under **ISO9000** quality systems certification.

Intersil products are sold by description only. Intersil Corporation reserves the right to make changes in circuit design and/or specifications at any time without notice. Accordingly, the reader is cautioned to verify that data sheets are current before placing orders. Information furnished by Intersil is believed to be accurate and reliable. However, no responsibility is assumed by Intersil or its subsidiaries for its use; nor for any infringements of patents or other rights of third parties which may result from its use. No license is granted by implication or otherwise under any patent or patent rights of Intersil or its subsidiaries.

For information regarding Intersil Corporation and its products, see web site <http://www.intersil.com>

Sales Office Headquarters

NORTH AMERICA

Intersil Corporation
P. O. Box 883, Mail Stop 53-204
Melbourne, FL 32902
TEL: (407) 724-7000
FAX: (407) 724-7240

EUROPE

Intersil SA
Mercure Center
100, Rue de la Fusee
1130 Brussels, Belgium
TEL: (32) 2.724.2111
FAX: (32) 2.724.22.05

ASIA

Intersil (Taiwan) Ltd.
Taiwan Limited
7F-6, No. 101 Fu Hsing North Road
Taipei, Taiwan
Republic of China
TEL: (886) 2 2716 9310
FAX: (886) 2 2715 3029