

OBSOLETE PRODUCT
See HA-2539

HA-2839

600MHz, Very High Slew Rate Operational Amplifier

November 1996

Features

- Low Supply Current 13mA
- Very High Slew Rate 625V/ μ s
- Open Loop Gain 25kV/V
- Wide Gain-Bandwidth ($A_V \geq 10$) 600MHz
- Full Power Bandwidth 10MHz
- Low Offset Voltage 0.6mV
- Differential Gain/Phase 0.03%/0.03 Degrees
- Enhanced Replacement for EL2039

Applications

- Pulse and Video Amplifiers
- Wideband Amplifiers
- High Speed Sample-Hold Circuits
- RF Oscillators

Description

The HA-2839 is a wideband, very high slew rate, operational amplifier featuring superior speed and bandwidth characteristics. Bipolar construction, coupled with dielectric isolation, delivers outstanding performance in circuits with a closed loop gain of 10 or greater.

A 625V/ μ s slew rate and a 600MHz gain bandwidth product ensure high performance in video and RF amplifier designs. Differential gain and phase are a low 0.03% and 0.03 degrees respectively, making the HA-2839 ideal for video applications. A full $\pm 10V$ output swing, high open loop gain, and outstanding AC parameters, make the HA-2839 an excellent choice for high speed Data Acquisition Systems.

The HA-2839 is available in commercial and industrial temperature ranges, and a choice of packages. For military grade product, refer to the HA-2839/883 data sheet.

Part Number Information

PART NUMBER	TEMP. RANGE (°C)	PACKAGE	PKG. NO.
HA1-2839-5	0 to 75	14 Ld CERDIP	F14.3
HA3-2839-5	0 to 75	14 Ld PDIP	E14.3
HA3-2839-9	-40 to 85	14 Ld PDIP	E14.3

Pinout

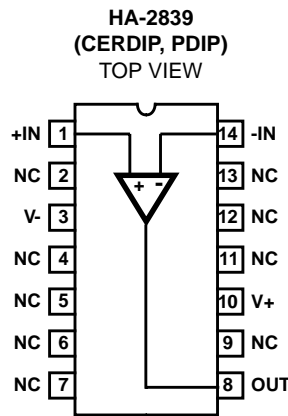

NOTE: No Connection (NC) pins may be tied to a ground plane for better isolation and heat dissipation.

HA-2839

Absolute Maximum Ratings

Voltage Between V+ and V- Terminals	35V
Differential Input Voltage.....	6V
Output Current	50mA

Operating Conditions

Temperature Range	
HA-2839-5.....	0°C to 75°C
HA-2839-9.....	-40°C to 85°C
Recommended Supply Voltage Range.....	±7V to ±15V

Thermal Information

Thermal Resistance (Typical, Note 2)	θ_{JA} (°C/W)	θ_{JC} (°C/W)
CERDIP Package	95	40
PDIP Package	80	N/A
Maximum Internal Quiescent Power Dissipation (Note 1)		
Maximum Junction Temperature (Ceramic Package).....	175°C	
Maximum Junction Temperature (Plastic Package)	150°C	
Maximum Storage Temperature	-65°C to 150°C	
Maximum Lead Temperature (Soldering 10s).....	300°C	

CAUTION: Stresses above those listed in "Absolute Maximum Ratings" may cause permanent damage to the device. This is a stress only rating and operation of the device at these or any other conditions above those indicated in the operational sections of this specification is not implied.

NOTES:

- Maximum power dissipation with load conditions must be designed to maintain the maximum junction temperature below 175°C for ceramic packages and below 150°C for plastic packages.
- θ_{JA} is measured with the component mounted on an evaluation PC board in free air.

Electrical Specifications $V_{SUPPLY} = \pm 15V, R_L = 1k\Omega, C_L \leq 10pF$, Unless Otherwise Specified

PARAMETER	TEMP. (°C)	HA-2839-5, -9			UNITS
		MIN	TYP	MAX	
INPUT CHARACTERISTICS					
Offset Voltage (Note 13)	25	-	0.6	2	mV
	Full	-	2	6	mV
Average Offset Voltage Drift	Full	-	20	-	$\mu V/^\circ C$
Bias Current (Note 13)	25	-	5	14.5	μA
	Full	-	8	20	μA
Offset Current	25	-	1	4	μA
	Full	-	-	8	μA
Input Resistance	25	-	10	-	k Ω
Input Capacitance	25	-	1	-	pF
Common Mode Range	Full	±10	-	-	V
Input Noise Voltage (f = 1kHz, $R_{SOURCE} = 0\Omega$, Note 13)	25	-	6	-	nV/\sqrt{Hz}
Input Noise Current (f = 1kHz, $R_{SOURCE} = 10k\Omega$, Note 13)	25	-	6	-	pA/\sqrt{Hz}
TRANSFER CHARACTERISTICS					
Large Signal Voltage Gain (Note 3)	25	20	25	-	kV/V
	Full	15	20	-	kV/V
Common-Mode Rejection Ratio (Notes 4, 13)	Full	75	80	-	dB
Minimum Stable Gain	25	10	-	-	V/V
Gain Bandwidth Product (Notes 5, 12, 13)	25	-	600	-	MHz
OUTPUT CHARACTERISTICS					
Output Voltage Swing (Notes 3, 13)	Full	±10	-	-	V
Output Current (Notes 3, 13)	Full	±10	±20	-	mA
Output Resistance	25	-	30	-	Ω
Full Power Bandwidth (Notes 3, 7)	25	8.7	10	-	MHz
Differential Gain (Notes 6, 11)	25	-	0.03	-	%
Differential Phase (Notes 6, 11)	25	-	0.03	-	Degrees
Harmonic Distortion (Notes 6, 13, 14)	25	-	-79	-	dBc

HA-2839

Electrical Specifications $V_{SUPPLY} = \pm 15V$, $R_L = 1k\Omega$, $C_L \leq 10pF$, Unless Otherwise Specified (Continued)

PARAMETER	TEMP. (°C)	HA-2839-5, -9			UNITS
		MIN	TYP	MAX	
TRANSIENT RESPONSE (Note 8)					
Rise Time	25	-	4	-	ns
Overshoot	25	-	20	-	%
Slew Rate (Notes 3, 10, 13)	25	550	625	-	V/ μ s
Settling Time: 10V Step to 0.1%	25	-	180	-	ns
POWER REQUIREMENTS					
Supply Current (Note 13)	Full	-	13	15	mA
Power Supply Rejection Ratio (Notes 9, 13)	Full	75	90	-	dB

NOTES:

3. $R_L = 1k\Omega$, $V_O = \pm 10V$, 0V to $\pm 10V$ for slew rate.
4. $V_{CM} = \pm 10V$.
5. $V_O = 90mV$.
6. $A_V = +10$.
7. Full Power Bandwidth guaranteed based on slew rate measurement using: $FPBW = \frac{\text{Slew Rate}}{2\pi V_{PEAK}}$, $V_{PEAK} = 10V$.
8. Refer to Test Circuit section of data sheet.
9. $V_{SUPPLY} = \pm 10V$ to $\pm 20V$.
10. This parameter is not tested. The limits are guaranteed based on lab characterization, and reflect lot-to-lot variation.
11. Differential gain and phase are measured with a VM700A video tester, using a NTC-7 composite VITS.
12. $A_V = +100$.
13. See "Typical Performance Curves" for more information.
14. $V_O = 2V_{p-p}$, $f = 1MHz$.

Test Circuit and Waveforms

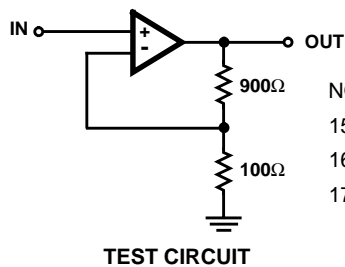

- NOTES:**
15. $V_S = \pm 15V$.
 16. $A_V = +10$.
 17. $C_L < 10pF$.

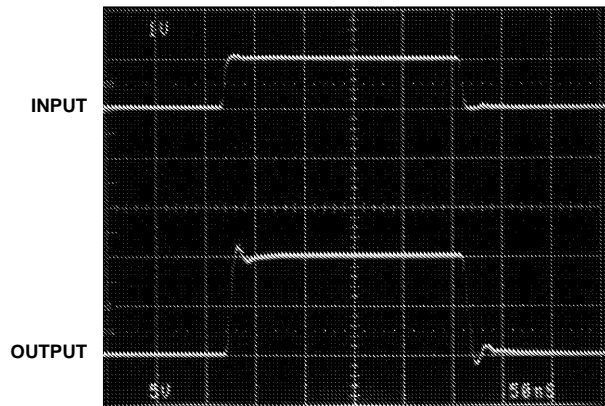

LARGE SIGNAL RESPONSE

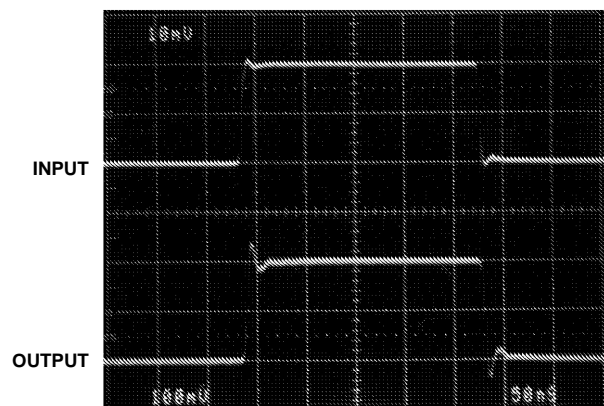

SMALL SIGNAL RESPONSE

Test Circuit and Waveforms (Continued)

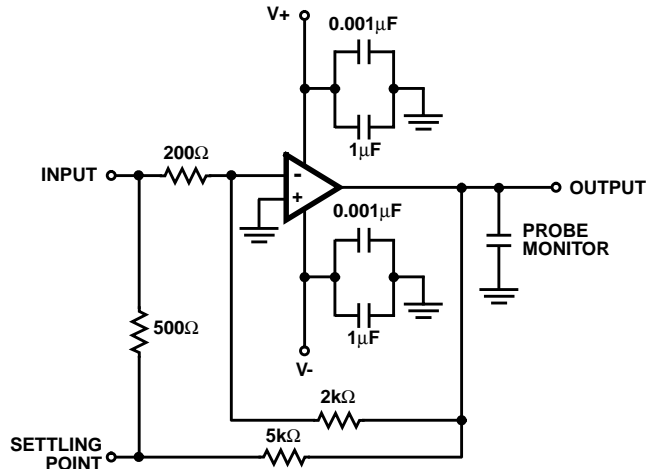

SETTLING TIME TEST CIRCUIT

NOTES:

18. $A_V = -10$.
19. Load Capacitance should be less than 10pF.
20. It is recommended that resistors be carbon composition and that feedback and summing network ratios be matched to 0.1%.
21. SETTTLING POINT (Summing Node) capacitance should be less than 10pF. For optimum settling time results, it is recommended that the test circuit be constructed directly onto the device pins. A Tektronix 568 Sampling Oscilloscope with S-3A sampling heads is recommended as a settle point monitor.

Typical Performance Curves $T_A = 25^\circ\text{C}$, $V_{\text{SUPPLY}} = \pm 15\text{V}$, $R_L = 1\text{k}\Omega$, $C_L < 10\text{pF}$, Unless Otherwise Specified

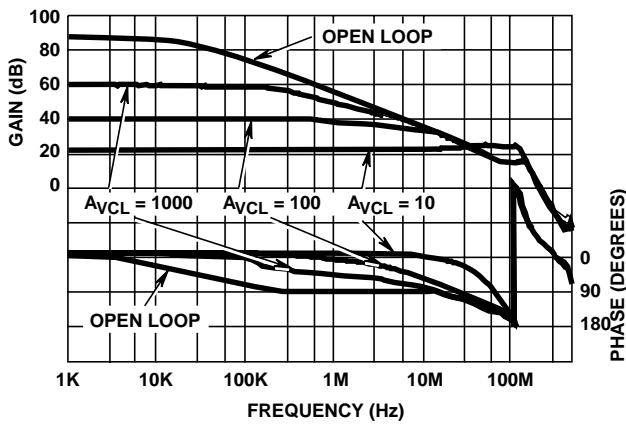

FIGURE 1. FREQUENCY RESPONSE FOR VARIOUS GAINS

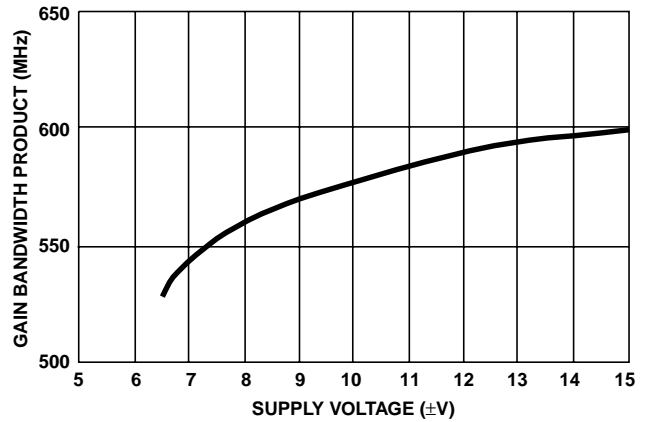

FIGURE 2. GAIN BANDWIDTH PRODUCT vs SUPPLY VOLTAGE

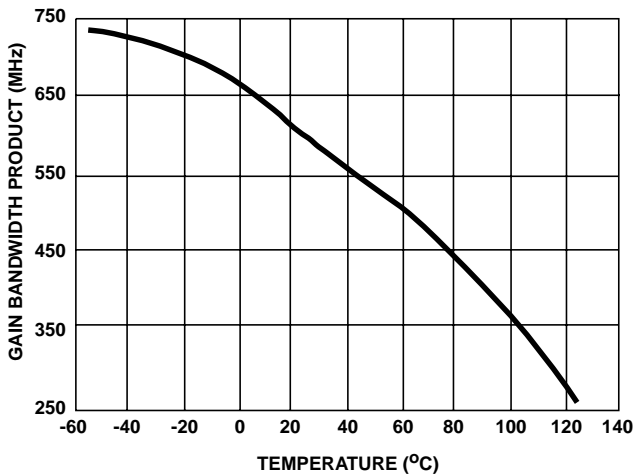

FIGURE 3. GAIN BANDWIDTH PRODUCT vs TEMPERATURE

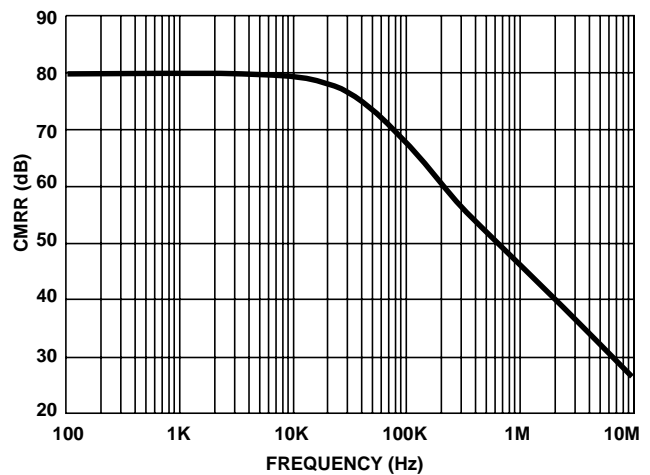

FIGURE 4. CMRR vs FREQUENCY

Typical Performance Curves $T_A = 25^\circ\text{C}$, $V_{\text{SUPPLY}} = \pm 15\text{V}$, $R_L = 1\text{k}\Omega$, $C_L < 10\text{pF}$, Unless Otherwise Specified (Continued)

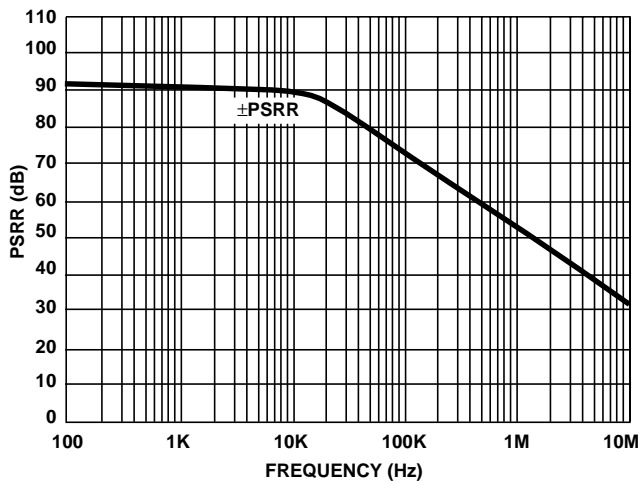

FIGURE 5. PSRR vs FREQUENCY

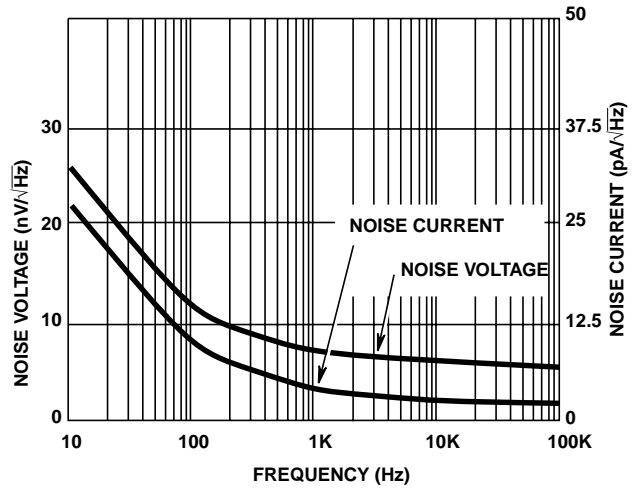

FIGURE 6. INPUT NOISE vs FREQUENCY

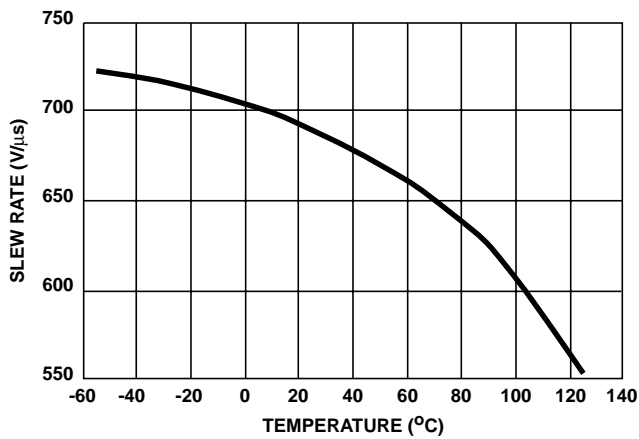

FIGURE 7. SLEW RATE vs TEMPERATURE

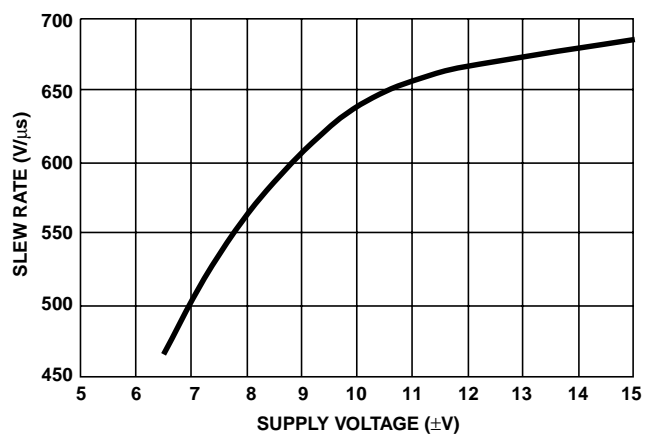

FIGURE 8. SLEW RATE vs SUPPLY VOLTAGE

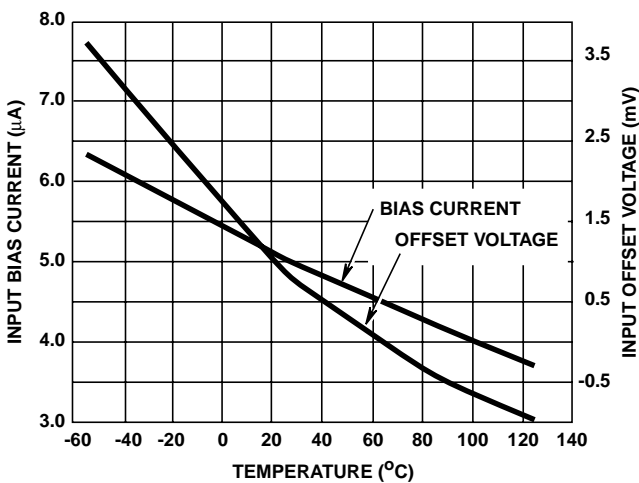

FIGURE 9. INPUT OFFSET VOLTAGE AND INPUT BIAS CURRENT vs TEMPERATURE

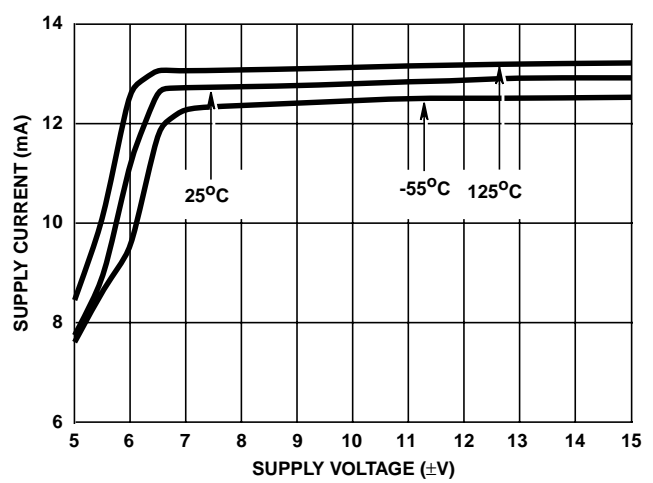

FIGURE 10. SUPPLY CURRENT vs SUPPLY VOLTAGE

Typical Performance Curves $T_A = 25^\circ\text{C}$, $V_{\text{SUPPLY}} = \pm 15\text{V}$, $R_L = 1\text{k}\Omega$, $C_L < 10\text{pF}$, Unless Otherwise Specified (Continued)

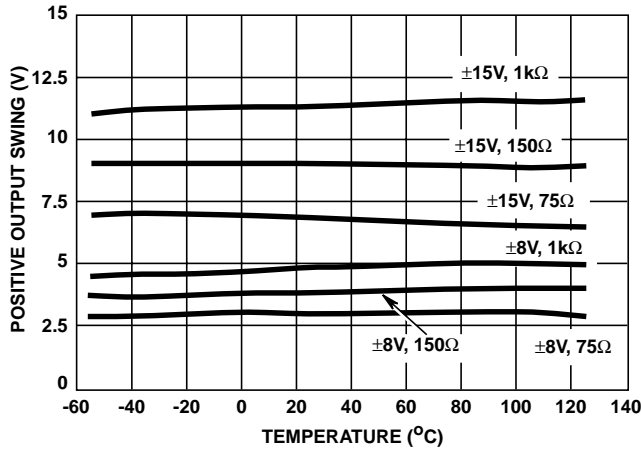

FIGURE 11. POSITIVE OUTPUT SWING vs TEMPERATURE

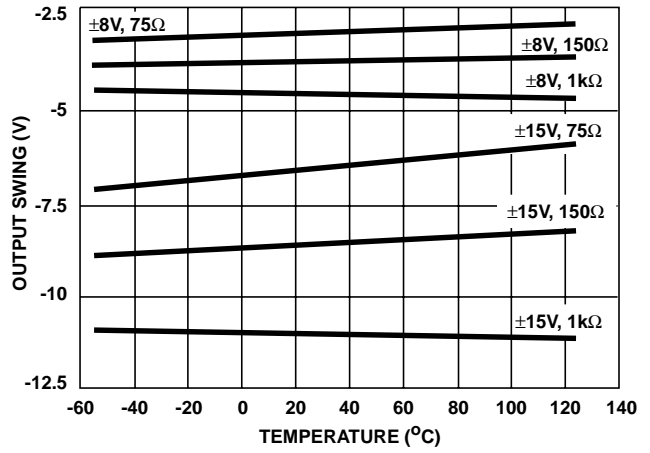

FIGURE 12. NEGATIVE OUTPUT SWING vs TEMPERATURE

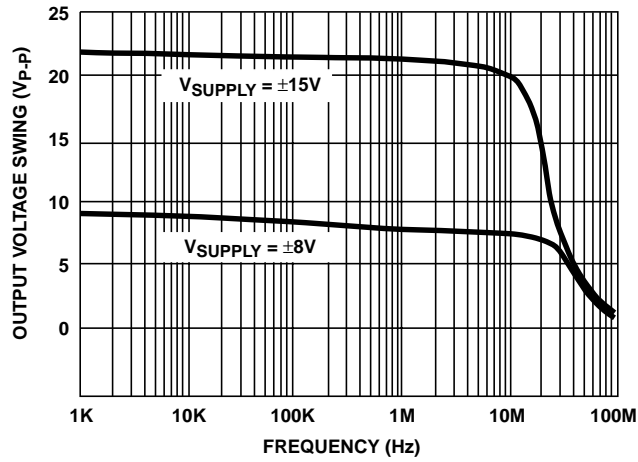

FIGURE 13. MAXIMUM UNDISTORTED OUTPUT SWING vs FREQUENCY

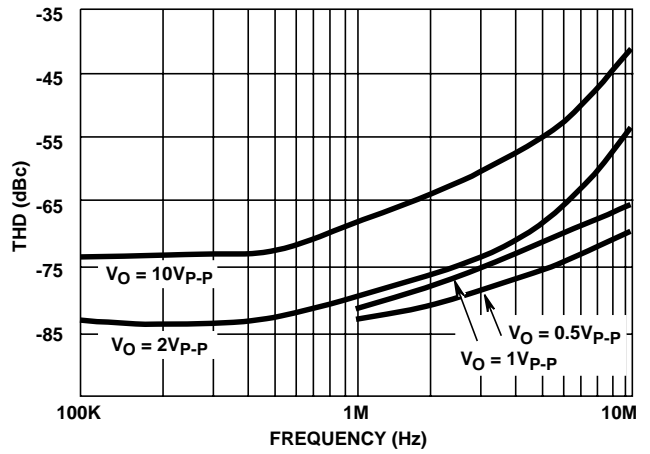

FIGURE 14. TOTAL HARMONIC DISTORTION vs FREQUENCY

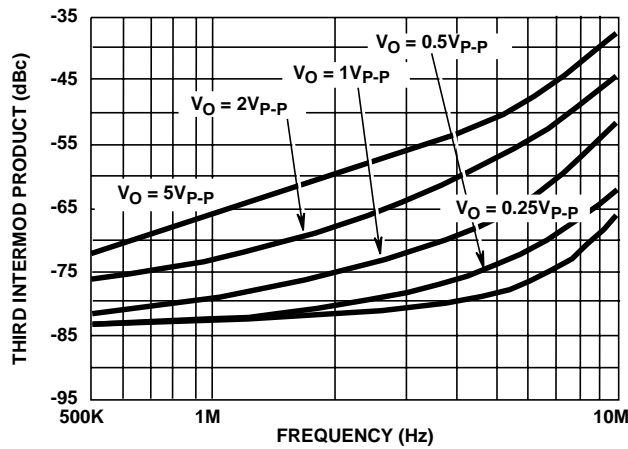

FIGURE 15. INTERMODULATION DISTORTION vs FREQUENCY (TWO TONE)

HA-2839

Die Characteristics

DIE DIMENSIONS:

65 mils x 52 mils x 19 mils
1650 μ m x 1310 μ m x 483 μ m

METALLIZATION:

Type: Aluminum, 1% Copper
Thickness: 16k \AA \pm 2k \AA

SUBSTRATE POTENTIAL

V-

PASSIVATION:

Type: Nitride over Silox
Silox Thickness: 12k \AA \pm 2k \AA
Nitride thickness: 3.5k \AA \pm 1k \AA

TRANSISTOR COUNT:

34

PROCESS:

High Frequency Bipolar Dielectric Isolation

Metallization Mask Layout

HA-2839

